

WIRELESS WORLD

AND

RADIO REVIEW

No. 172. [No. 9. VOL. XI.]

2nd DECEMBER, 1922.

Registered at the G.P.O. as a Weekly Newspaper.

Doing away with the aerial

When there is electric light, an aerial is unnecessary. Plug a "Ducon" into an ordinary lamp holder or wall socket; connect to the wireless receiver and you will receive the broadcasting perfectly. The "Ducon" gives satisfactory results with all types of receivers, from crystal to multi-valve.

Dealers not yet stocking are invited to write for trade terms. Obtainable from all leading wireless dealers, electrical contractors and stores or direct from the makers.

DUCON 10%

The DUBILIER CONDENSER Co. (1921) Ltd.

Ducon Works, Goldhawk Road, SHEPHERD'S BUSH, LONDON, W.12.

Telephone—Hammersmith 1084. Telegrams—"Hivolcon, Phone, London."





STERLING No. 1 CRYSTAL RECEIVING SET

Specially designed for use in connection with the Wireless Telephony Broadcasting Scheme, and is suitable for a range of about 25 miles.

PRICE £7-12-6

TO BE OBTAINED FROM ALL DEALERS OR DIRECT FROM:—

STERLING TELEPHONE & ELECTRIC CO., LTD.

210-212, Tottenham Court Road,
LONDON : : : W.1

Telephone No. : 4144 Museum (7 lines)
Telegrams : "Cucumis, Wesdo, London."

Works : DAGENHAM, ESSEX.

BRANCHES :

NEWCASTLE-ON-TYNE : 9, Clavering Place.
CARDIFF : 8, Park Place.

IMMEDIATE DELIVERY

“Wireless for all”

Before you decide on the construction of your set. It will pay you to have particulars of—

Condensite Celoron

For PANELS and OTHER PARTS.

This material is waterproof, immune to atmospheric and climatic conditions, will not warp, has high surface and volume resistivity, high di-electric strength, low specific gravity.

LET US QUOTE YOU

SEND PARTICULARS OF YOUR EXACT REQUIREMENTS TO
THE MANUFACTURERS

DIAMOND FIBRE CO. LTD.

DIAMOND-FIBRE
WORKS

HIGH ROAD
SOUTH TOTTENHAM, N.15.



The instruments advertised on this page are BROADCAST RECEIVING instruments which have been approved by the Postmaster-General and given registered numbers. They bear the seal of the British Broadcasting Company, and may be used under the Broadcast Receiving Licence, which can be obtained at any Post Office. Every instrument is thoroughly tested and guaranteed scientifically perfect, efficient in operation and entirely British.

Simplex

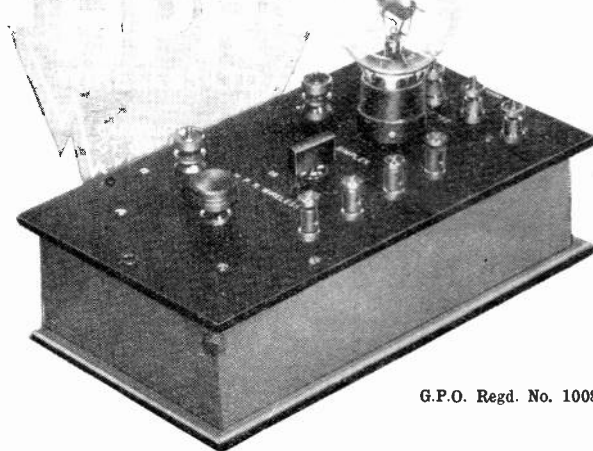

G.P.O. Regd. No. 1008.

The "Simplex" Single Valve Wireless 'Phone has been so constructed that it can be operated without any knowledge of wireless. The connections to the batteries are simplified by a simple colour scheme. The instrument gives perfect rendition of Broadcast Music and Telephony. Note magnifiers may be added, making a two or three-valve 'phone.

Price (without accessories) £5 5s.
 Price with valve, headphones, four-volt accumulator, 50-volt H.T. battery, and aerial £10 15s.
 (Plus the charge of £1 made by the British Broadcasting Company, Ltd.)

Hilophone

(One Detector, 1 H.F., 1 L.F. Valves.)

An ideal three-valve set, specially designed to pick up broadcasting in any part of Great Britain, amateurs, ships, etc. Fitted with the famous H.P.R. Patent Automatic Wavelength Indicator, which makes "tuning in" easier than turning on the electric light. Price (without accessories) £19 19s.
 Price with three valves, headphones, 6-volt accumulator, 50-volt H.T. battery, and aerial £29

(Plus the charge of £2 5s. made by the British Broadcasting Co., Ltd.)

G.P.O. Regd. No. 0113.

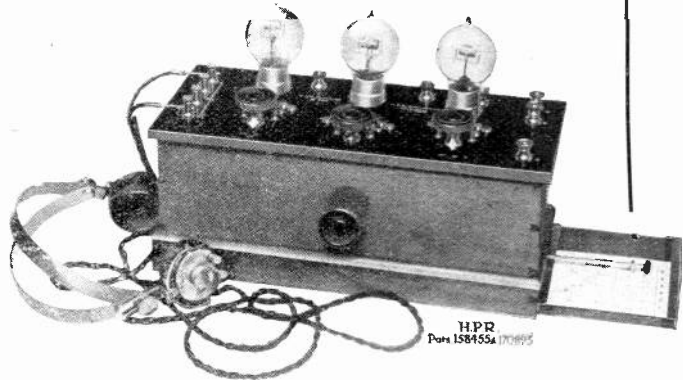

Full particulars of these and other instruments of convenience for expert and novice may be had upon application. H.P.R. Instruments may be obtained from Messrs. Hamley Bros., Negretti & Zambra, Civil Service Co-Operative Society, Ltd., Shoobreds, Ltd., Army & Navy Co-Operative Society, Ltd., Selfridge & Co., Ltd., and J. John Ward (No. 6 Strand), etc., etc., and from all leading dealers in the provinces.

TRADE ENQUIRIES INVITED.

H.P.R. WIRELESS, LTD.

Pioneer Designers and Makers of Fine Valve Receiving Instruments for Amateurs.

Head Office and Demonstration Room :

**CARLTON HOUSE, GREAT QUEEN STREET,
 KINGSWAY, LONDON, W.C.2.**

Tel. REGENT 1719.

(Opposite Kingsway Theatre.)

BURNDEPT

WIRELESS APPARATUS

Leeds Offices and Showrooms

WE have now removed our office and showrooms to more commodious premises at London Assurance House, Bond Place, Leeds, third floor (ascend by electric lift) where complete range of all our apparatus is on view, and a large stock held for immediate delivery.

This office is the Headquarters of our North Eastern district comprising Northumberland, Durham and Yorkshire, and is under the management of Mr. Ernest O. Phillips.

Service agents are still required in a few towns in this district. Applicants are requested to communicate direct to the Leeds office.

BURNDEPT LTD.

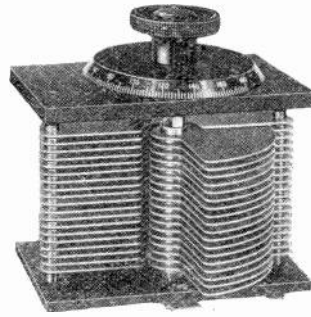

Specification of our well-known CONDENSERS. Highest grade Aluminium Plates, Brass Washers machined to a limit of + or - .011" Adjustable Brass Bush at bottom, Fixed Brass Bush at top. These Condensers are built to stand HARD continuous use, and we GUARANTEE THEM.

Value in M.F.	Panel Mounting in Parts	Panel Mounting Assembled	Cabinet Mounting in Parts	Cabinet Mounting Assembled	Cabinet Mounting Assembled in Cabinet	Polished Mahogany Cabinet
-.0015 ..	23/-	25/6	24/-	26/6	33/-	6/3
-.001 ..	18/9	19/6	17/9	21/-	26/-	5/6
-.00075 ..	13/6	16/3	14/6	16/6	22/-	5/6
-.0005 ..	10/6	13/-	11/9	13/9	18/-	4/6
-.0004 ..	10/-	12/6	11/-	13/3	17/6	4/6
-.0003 ..	9/-	11/6	10/-	12/-	16/-	4/-
-.0002 ..	7/-	9/-	8/-	9/6	13/6	4/-
-.0001 ..	6/-	8/-	7/-	8/6	12/6	4/-
Vernier ..	—	4/6	—	5/-	9/-	3/6

Fitted with Bevelled Ebonite Dial 1/9 extra. Special Sizes made to Order. Price list on request. ALL SUNDRIES AND COMPONENTS IN STOCK. ORDERS OVER 20/- CARRIAGE PAID. TRADE ENQUIRIES SOLICITED.

THE "BROADWAY" RADIO WORKS
DEVONSHIRE ROAD, BEXLEYHEATH, KENT.

Everything for Wireless.

G. E. MABEY

47, RINGFORD ROAD,
WEST HILL, WANDSWORTH, S.W.18
Works—Battersea, S.W.

Resistance Switch ready for board	2/10 each
Ebonite Knobs with metal	6d. "
Ebonite valve socket nuts and screws	1/8 "
Terminals	10d. and 1/- per dozen
Condenser Plates	10d. and 1/- per dozen pairs
Condenser fixed in Ebonite	1/6 each
Condenser and Grid leak intercoupling	2/10 "
Condenser Telephone	1/6 "

Ebonite panels, parts, cases, boxes, etc. Valve and crystal sets complete. Anything made to your own specification. Trade supplied. Enquiries invited. List on application. Substantial discount for quantities. Prompt delivery.

L.O. HERE IT IS.—M. E. C.

Crystal Receiver complete with everything in polished Cabinet. Royalty paid to B.B.C. Reg. No. 138. Carriage paid from stock. All tested and guaranteed they speak loud and clear.

Price
£3 : 15 : 0
complete.

M.E.C., Crownhill Road, Harlesden, London, N.W.10.
Willesden 3370

"WESTERN COUNTIES" ACCUMULATORS

FOR WIRELESS USE

Write for Complete Price List.

Write for Complete Price List.

The most Reliable and Moderate Priced Accumulator on the Market.

4 Volts.			6 Volts.		
80	amphours	£1 8 6	60	amphours	£1 17 6
120	"	1 17 6	90	"	2 5 0
150	"	2 5 6	120	"	2 12 6
180	"	2 19 6			

The Western Counties
Electrical & Engineering
Company,
Midland Bank Chambers,
Telegrams—
"Electron, Yeovil"
YEovil. Telephone—
223 Yeovil

Branch for Messrs. BURNDEPT LTD.

The Rolls-Royce of Broadcast Receivers

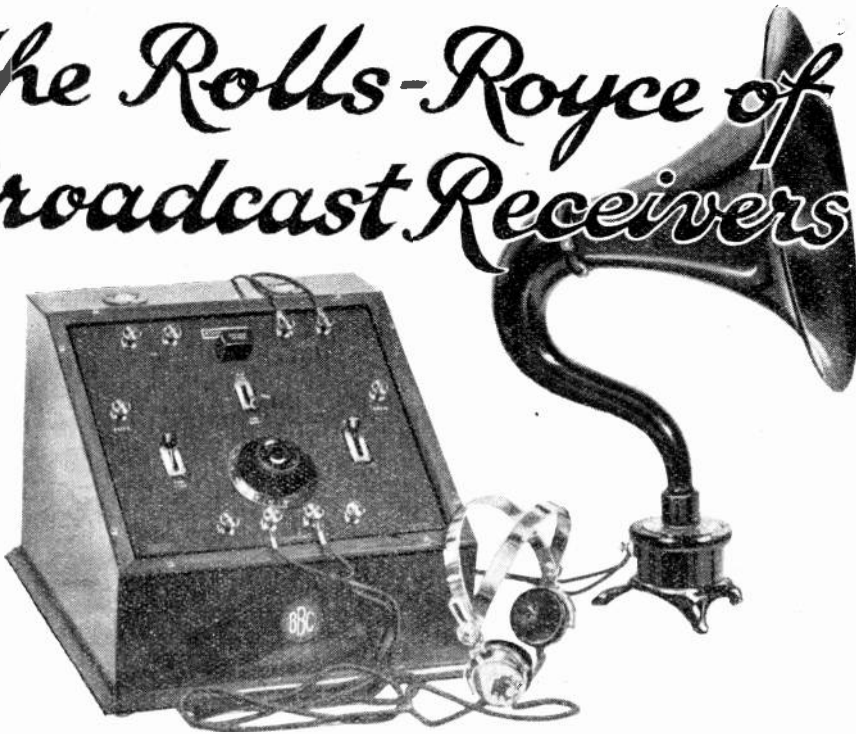

Ethophone III and Loud Speaker

A THREE-VALVE RECEIVER with self-contained valves and H.T. Battery. Wavelength range 250 to 650 metres, plug-in coils permit indefinite extension of wavelength. Range of reception over 150 miles on head-telephones, or 80 miles on loud speaker.

Supplied in polished walnut, complete with valves and H.T. Battery - - - Price 34 guineas.

Write for our fully illustrated catalogue. Price 1/-

All **BURNDIPT** Valve Apparatus is duly licensed under Marconi Patents for Amateur use in Great Britain.

BURNDIPT, LTD., London Office & Showrooms: 15, Bedford Street, Strand, W.C.2
Aerial and Bastnor Works, BLACKHEATH, S.E.3

Exchange Buildings, 133, New Street, BIRMINGHAM.

236, Argyle Street, GLASGOW.

London Assurance House, Bond Place, LEEDS.

61, Bridge Street, MANCHESTER.

Midland Bank Chambers, YEOVIL.

BURNDIPT

WIRELESS APPARATUS

T.M.C. Wireless

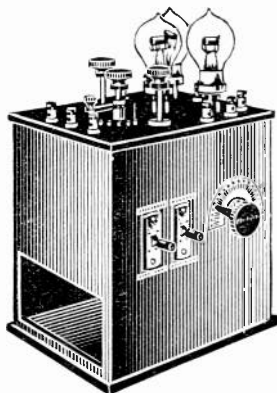

T.M.C. 3-VALVE BROADCASTING SET

A Revelation in Wireless Sets employing one-valve detector, two valves for low frequency amplification. Apparatus mounted includes Variable Filament Resistance, three Valve Sockets, Grid Leak and Condenser, two highly efficient Transformers, Grid Potential Blocking Condenser, Variable Condenser, Series Parallel Switch, Switch for using Loud Speaker or Headphones, Tuner and Reactance. Complete with Three Valves, Loud Speaker and set of "De-Luxe" Headphones. Mounted in polished Walnut. Size $9\frac{1}{2} \times 7 \times 10\frac{1}{2}$ inches high.

**THE MARVELLOUS 3-VALVE SET THAT WAS
THE FEATURE OF THE EXHIBITION.**

THE LONDON TELEPHONE (NEW SYSTEM) CO., LTD.
DONINGTON HOUSE, NORFOLK ST., STRAND, W.C.2.
TELEPHONE : CITY 8612. TELEGRAMS : OAKMENT, ESTRAND.

Agent:
F. ESCOTT,
 23, High St.,
 Hampstead.

Introducing the
AUDIOPHONE
a Broadcast Receiver of MERIT

Agent:
J. T. HARTWELL,
 5, West Chapel St.,
 Mayfair, W.1.

Efficient.

Specification.-1.

Manufactured, assembled and finished by highly skilled hand labour throughout. Bare, tinned internal wiring, bent on formers, and soldered at all connections, thus ensuring a noiseless circuit.

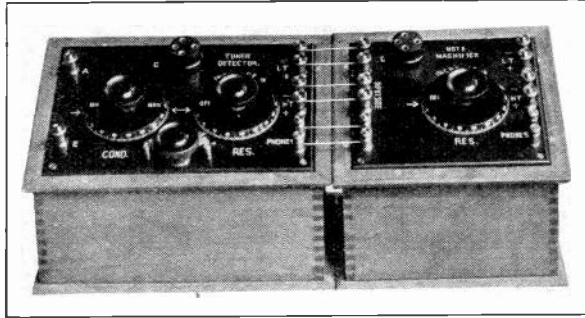

TUNER DETECTOR.
 Price as shown **£7 : 7 : 0**
 Complete with:—Siemens 60 v. H.T.
 4 v. 50 amp. (actual) L.T., and M.O.
 Valve R. Type **£11 : 12 : 0**
Prices include Marconi Royalty and commission to B.B.C.

NOTE MAGNIFIER.
 Price **£4 : 5 : 0**
 Complete with:—Marconi
 Osram R. Type Valve
 £5 : 2 : 6

Highly Sensitive.

EMPLOYING THE
 UNIT SYSTEM.

Specification.-2.

Polished ebonite panel, engraved white, functions of all knobs and terminals clearly indicated. The whole mounted in desk style polished mahogany cabinet. Wave-length range 300-550 m. Higher wave-lengths obtained by means of plug-in coils.

*Fully approved by
 H. M. Postmaster-
 General.*

TERMS :—Cash with order, or instruments on five days approval against full deposit.

Manufactured under Marconi Licence by **J. R. WRIGHT, 10, Carton St., Baker St., W.1.**

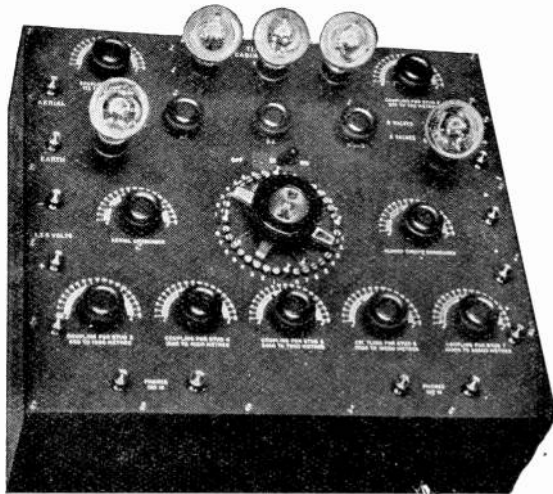

(REGISTERED DESIGN)

**TINGLEY
 UNIVERSAL
 RECEIVER**

All "Tingley" Valve Apparatus is duly licensed under Marconi Patents for Amateur use in Great Britain.

Offices and Showrooms :
 92, Queen Street, Hammersmith,
 London, W.6.

Offices and Works :
 Phone—HAMMERSMITH 1916
 Telegs.—"TINGOIDAR LONDON."



DIRECTION AND POSITION FINDING BY WIRELESS

Price
9/-
Nett

By R. KEEN
B.Eng. (Hons.) Sheffield, A.M.I.E.E.
Demy 8vo. 363 Pages
Over 250 Photographs and Diagrams

Post
9/9
Free

This book deals not only with the principles of the subject but with the constructional details of Direction Finding Installations.

It describes the principles of Direction and Position Finding in this country in such a way that the subject may be grasped easily by engineers tackling this field of wireless work for the first time.

CONTENTS.

The Theory of the Wireless Direction Finder ; Valve Amplifiers and Detectors ;
Maps ; Position Finding ; Night Effect and other Freak Phenomena ;
The Shore D.F. Station ; The Ship D.F. Station ; The Aircraft
D.F. Station ; Fault Clearing and Maintenance ; Notes
on Field and Nautical Astronomy ; Bibliography.

The Wireless Press, Ltd.
12-13, Henrietta Street,
London, W.C.2

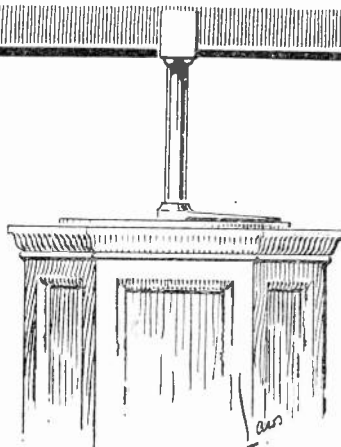

CAN YOU DECIPHER THIS ?



MORSE MADE EASY

By A. L. RYE

PRICE **3^D** NET. · POST FREE **3^{1D}/₂**

Printed on strong linen backed card, this valuable illustrated explanation can be carried about ready for use anywhere and everywhere.

A thorough system of memorising is suggested which will facilitate the learning of the Morse Code in the shortest possible time.

THE PERRY AUTO-TIME MORSE SYSTEM

By F. W. PERRY

16 Pages. With Illustrations.

PRICE **6^D** NET. POST FREE **7^D**

An aid to the rapid acquirement of speed in the transmission and reception of the Morse code. Learn Morse and you will never get tired of wireless. Far more interesting even than the wonderful broadcasting telephony concerts and events. The constantly changing personal messages sent by wireless telegraphy open up a vast field of interest, amusement and knowledge. The Perry system teaches you Morse interestingly so that its study is a real hobby.

THESE BOOKS WILL HELP YOU

THE INTERNATIONAL MORSE CODE CARD

PRICE **2^D** NET. POST FREE **3^D**

Contains the full alphabet, with punctuation marks, figures, abbreviations and contractions.

ACQUIRING THE CODE

By E. P. GORDON

29 Pages. With Illustrations.

PRICE **2/6** NET. POST FREE **2/9**

An American book written to assist the newcomer in the radio field to a quick knowledge of the meaning of the dots and dashes that are unintelligible to the novice until proficiency has been obtained in the telegraphic code.

THE WIRELESS PRESS, LIMITED

12-13, Henrietta Street, Strand, London, W.C.2

LESLIE McMICHAEL

LTD.

PROVIDENCE PLACE, WEST END LANE, KILBURN, N.W.6

Bus Services 1, 8, 16, 28, 31 all pass West End Lane

Telephone HAMPSTEAD 1261 Nearest Tube Station: KILBURN PARK (BAKERLOO)

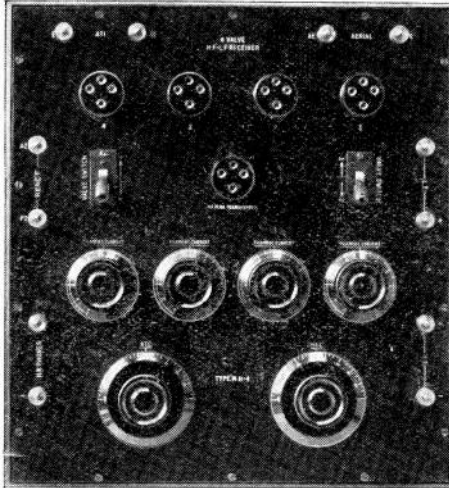

4 VALVE DETECTOR AMPLIFIER. TYPE M.H.4

This instrument is designed for those who require perfection in finish and performance.

The set is of highest grade finish, consisting of a 4-valve Detector Amplifier fitted with a full range of controls, and being provided with selector switches by which 2, 3, or 4 valves can be used individually at will.

The strength of signals is such as to permit of an almost unlimited number of headphones to be used, or a Loud Speaker can be connected, thus making possible collective enjoyment of music, speech, etc.

Price - £25 0 0

Accessories for COMPLETE STATION

include the following :—Tuning Coil Holder (for 3 coils)—Tuning Coils, 150 to 3000 metres—High Tension Battery—Low Tension Battery—Aerial, 100 ft.—Insulators (4)—Headphones, 8000 ohms **AT A COST OF £14** (Brown's)—4 Valves—6 " Plug-in " Transformers. **ABOUT £14**

Amplion Loud Speakers can also be used if desired. Prices from **£2 7s. 6d. each**

A Splendid Christmas Gift which will give great pleasure to the owner and all his relatives and friends. Demonstrations Daily. Visit our Showrooms.

NOTE.—Other M.H. Sets, 1 to 3 valves, of similar design and unsurpassed efficiency, are mentioned in detail in our NEW M.H. Booklet, 6d. post free. All applying for same will also receive our GENERAL CATALOGUE with 16 pages and 100 illustrations. (All our valve apparatus is manufactured under Marconi Licence.)



SKINDERVIKEN BUTTON.

A Supersensitive Microphone.

Known all over the world and patented in every civilised country. Over 60,000 sold. ENGLISH Manufacture.

Make up your own Loud Speaker.

Transmit your GRAMOPHONE music to any room in your house.

The only practical Microphone for use in Detectophone Sets.

Price 5/- each

Special Low Resistance Receivers (for use with Skinderviken Buttons) 10/- each

Special Gramophone Attachments 1/-

Write for 16 page BOOKLET fully illustrated and containing much useful information for all interested in Electrical Sound Transmission. 6d. Post free.

Sole Proprietors:

MIKRO LTD., 274/6, Pentonville Rd., London, N.1 (Opp. King's Cross (Met.) Rly. Station).

You must have the best Accumulators for Wireless

Low Prices

Send for Complete Lists

The **ESSEX** Accumulator Co., Ltd.
499, Grove Green Road, Leytonstone, E. 11

Telephone Wanstead 749

BROADCASTING RECEPTION SETS

Send for Illustrated
Catalogue.

Trade enquiries
invited.

One Valve Set, com-
plete for Working **£7 10 0**
including all Accessories

G.P.O. Prov.
No. 1027.

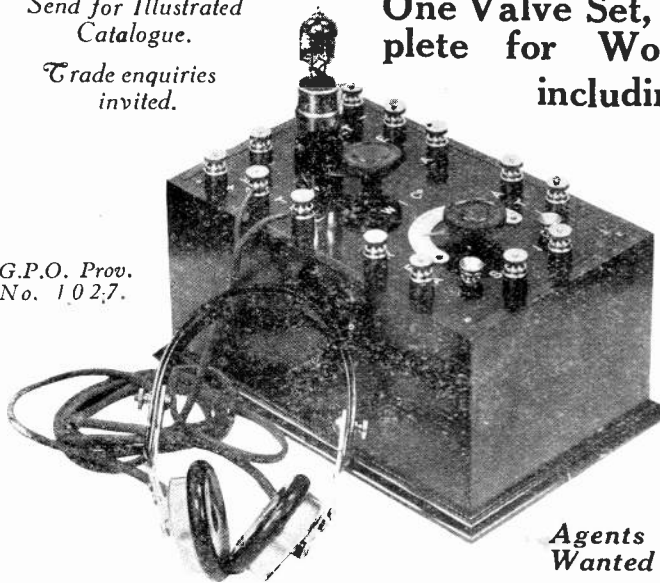

Description.

Single Valve, mounted on polished $\frac{1}{2}$ " ebonite panel with variable condenser, smooth acting resistance, grid leak and condenser and all terminals clearly engraved in white, in a mahogany polished cabinet, 9" x 5" x 5" .. £3 15s.
A TAPPED COIL for wavelengths up to 900 metres with two terminals for coils for any higher wavelengths. The coil is enclosed and the tapings are brought out to an 8-way switch mounted in the front of the cabinet.

Accessories included.

Siemens' 54-volt high-tension battery with plugs for altering the voltage, 15s.
Four-volt 50 amp. hour low tension accumulator in case with carrying strap .. £1 4s.
One pair of Sensitive Head Phones of 4,000 ohms resistance .. £1 1s.
One Mullard "Ora" Detecting Valve .. 15s.
Total £7 10s.

Agents
Wanted

Wireless Installations Ltd. 15, ALDERSGATE STREET,
LONDON, E.C.

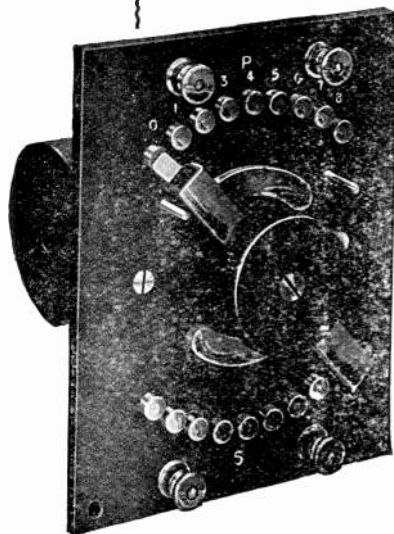

9 stage H.F. Trans-
former, tapped
primary and second-
ary. Range 150-
25,000 metres.

COMPLETE sets of Wire-
less Apparatus in stock
ready for immediate
delivery; also Amplifiers,
Tuners, Loud Speakers and
all components.

WE place our experience
at your disposal—send us
your enquiries, or call—we
will gladly give you expert advice.

NEGRETTI & ZAMBRA
38, HOLBORN VIADUCT, E.C.1
BRANCHES: 5 LEADENHALL ST., E.C.3
AND.....122 REGENT STREET, W 1
· LONDON ·

RADIO INSULATION

AS SPECIFIED AND USED BY THE BRITISH ADMIRALTY

BRITISH MADE

PAXOLIN

BRITISH MADE

TUBES DISCS PLATES, &c.

MANUFACTURED IN ALL FORMS, SIZES AND THICKNESSES

BY

THE MICANITE & INSULATORS Co. LTD.

EMPIRE WORKS

WALTHAMSTOW

LONDON, E.17

TELEGRAMS:—"MYTILITE, PHONE, LONDON."

TELEPHONES:—WALTHAMSTOW 738, 739

BRITISH EBONITE TO GOVERNMENT
SPECIFICATION
FOR BRITISH WIRELESS.

MANUFACTURED BY:

THE BRITISH EBONITE CO., LTD.

HANWELL

APPLY FOR LIST "W."

LONDON, W.7

SPECIAL QUALITY RODS, TUBES,
and SHEETS FOR WIRELESS.
ALL USUAL SIZES KEPT IN STOCK.
Grained Ebonite is a Speciality.

TELEGRAMS: "Ebonitical, Han, London."
PHONE: Ealing 1689.

WHOLESALE
ONLY.

TOMLINSON

LONDON, LIMITED.

Demonstrations
Daily.

Demonstrations
Daily.

3, FINCHLEY RD., ST. JOHN'S WOOD, N.W.8
Hampstead 1844

**THE NEW
"TOMLINSON"
CATALOGUE :**

*A Booklet every
Wireless man
should
have.*

SEND 2d. in stamps to-day for the new illustrated "Tomlinson" Catalogue, containing full descriptions of our wide and varied stock of Wireless apparatus, each piece of which carries our guarantee of reliable quality. This booklet will help you to settle your Wireless requirements in the most economical and satisfactory manner possible. Among the many items fully described are :—

Single Valve Detector Receiver Panel	£5 : 5 : 0
Two Valve Receiver	8 : 8 : 0
Three Valve Detector Amplifier	14 : 14 : 0
Four Valve Detector Amplifier	25 : 0 : 0

*Let us quote you for a COMPLETE RECEIVING STATION—
everything you need, ready for IMMEDIATE RECEPTION of
broadcasted music, speech, etc.*

TO TEST YOUR HIGH TENSION BATTERY YOU MUST USE A HIGH RESISTANCE VOLT METER

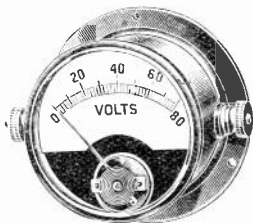

Moving Coil Type
2½ inch dial

We have designed a suitable instrument, to read to 80 volts.

Can be supplied in polished brass or nickelled case

Price 45/6 each

POST FREE. CASH WITH ORDER

WHITE ELECTRICAL INSTRUMENT CO. LTD.

2, 4 and 6, Gloucester Street, Clerkenwell, London, E.C.1

Telegrams : Voltograph, London.

Phone : City 8660.

TONS

of **EBONITE SHEET** in Stock for immediate delivery in qualities suitable for all classes of **WIRELESS WORK.**

SHEETS - RODS TUBES - PANELS

TUBES and ROTORS for Variometers.
MOULDED KNOBS (various patterns),
COMBINED DIALS AND KNOBS,
3", 3½" and 4" diameters.
Do. for Fil. Res. and Vario-Couplers.
AERIAL INSULATORS.

Wholesale only.

**AMERICAN HARD RUBBER
COMPANY (Britain) LIMITED,**
13a, Fore Street, London, E.C.2
Teleg. "Eboniseth, Ave., London," Phone; Central 12754.

WIRELESS PARTS

AND ACCESSORIES AT MANUFACTURERS' PRICES

Terminals, solid brass, knurled, large, 2/- doz. ;	gross	21/-
Terminals, solid brass, knurled, small, 1/5 doz. ;	gross	15/-
Valveholders, best finish	each	1/-
Porcelain Insulators	each	6d.
Filament Resistances, with special stop stud	each	4/-
Brass Rod, square, 13"	each	6d.
Slider and Plunger	doz.	7/6
Switch Arms, best Ebonite Knob, 4-leaf contact	each	2/6
Contact studs	doz.	1/-
100 ft. Aerial Wire, 7/22s best copper, enamelled	doz.	3/11
Crystal Detector, mounted on ebonite base, ebonite handle, universal joint, heavy brass terminals	each	4/6
Accumulators, 4 volt 40 amps.	each	20/9
Accumulators, 6 volt 40 amps.	each	29/6
Volt and Ammeters, Flush or Raised Fitting :-		
Plated	each	10/6
Black Enamel	each	10/-

SPECIAL TERMS TO THE TRADE.

We shall be glad to quote for all components of the first quality at equally low prices to the above selection from our list. Every article tested before leaving our Warehouse. Money returned if not satisfied.

Terms: Cash with order. Orders over 20/- carriage paid. For a short period only we are offering **HANDY BENCH VICE**. Specially suited for the Wireless Workshop. 2" jaws, all steel. Sheffield make. The tool you have been looking for, carriage paid 6/11

The "Abro" Motor Co.,

Wireless Dept.,
184 & 186, London Road, Manchester.
Works: 73 & 75, Downing Street and Hague Street.
Phone—Central 6142.



TRADE MARK

**The WHITECROSS
COMPANY, LIMITED**
:: WARRINGTON ::

Manufacturers of All Descriptions of
**WIRE ROPES
AND WIRES**

The most reliable and efficient
Batteries for Wireless Work are

D.P.

STORAGE BATTERIES

D.P. Batteries are made to fit almost any size of box. The output of our Works runs to hundreds of thousands of plates yearly.

Write us for particulars

The D. P. BATTERY CO., LTD.,
BAKEWELL — DERBYSHIRE
& 11 Victoria St., London, S.W.

STALLOY TRANSFORMER LAMINATIONS
 SOLE MANUFACTURERS AND SUPPLIERS
JOSEPH SANKEY & SONS LTD
 WORKS: BILSTON, STAFFS. London Office: 168 REGENT ST. W.I.
 TELEPHONE RECEIVER DIAPHRAGMS

THE WIRELESS WORLD AND RADIO REVIEW

THE OFFICIAL ORGAN OF THE WIRELESS SOCIETY OF LONDON
A MAGAZINE DEVOTED TO WIRELESS TELEGRAPHY AND TELEPHONY

CONTENTS

Conversion of the Townshend Wavemeter. By B. E. Alston	- - - - -	289
A Revolving Coil Holder	- - - - -	291
The Johnsen-Rahbek Loud Speaking Amplifier. By S. G. Crowder, Grad.I.E.E.	- - - - -	292
Electrons, Electric Waves, and Wireless Telephony. By Dr. J. A. Fleming, F.R.S.	- - - - -	294

Contents continued on next page.

THE SUPER 3-COIL MOUNTING

THIS Instrument is specially designed to enable exceptionally fine adjustment of the degree of coupling between the coils, and at the same time to obviate capacity effect of the hand when tuning. The knobs, in the front of the instrument, actuate the two outer coil holders by means of special insulated gearing which ensures smooth and regular movement. The standard ratio of gearing is 4 : 1 but any ratio can be adapted to order. The whole fitted on solid ebonyite column and mounted on polished teak baseboard. Complete with all necessary fittings exactly as illustrated. **£3**
 Prov. Pat. No. 131/22. Regd. Design No. 687086.

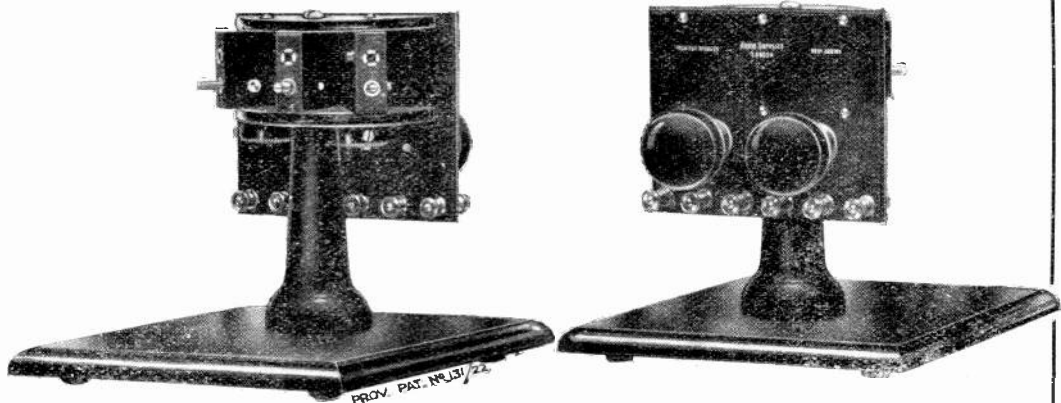

RADIO SUPPLIES, 234, High Holborn, London, W.C.1
 Phone: HOLBORN 2188.

THE WIRELESS AGETHE AMERICAN MONTHLY JOURNAL OF
WIRELESS TELEGRAPHY AND TELEPHONY

A "Go-a-head" Magazine for Operators and Amateurs.

Sole European Agents: THE WIRELESS PRESS LTD., 12-13 Henrietta St., Strand, London, W.C.2

CONTENTS (Continued)

Inductance Coils for Short Wavelengths	- - - - -	299
A Syphon Recorder of Simple Design. By W. Winkler	- - - - -	301
Wireless Club Reports	- - - - -	303
Notes	- - - - -	308
Correspondence	- - - - -	309
Calendar of Current Events	- - - - -	310
A Mechanical Model Illustrating the Action of the Three-Electrode Valve. By G. G. Blake	- - - - -	311
Questions and Answers	- - - - -	315
Share Market Report	- - - - -	320

THE WIRELESS WORLD AND RADIO REVIEW is published weekly on Saturdays.

All correspondence relating to contributions should be addressed to THE EDITOR, THE WIRELESS WORLD AND RADIO REVIEW, 12-13, Henrietta Street, Strand, London, W.C.2.

No responsibility can be taken for MSS. or photographs sent without stamps to defray cost of return postage.

Editorial and Publishing Offices: 12-13, Henrietta Street, Strand, London, W.C.2.

Telegraphic Address: "Radionic, Rand, London." Telephone No.: Gerrard 2807.

Advertisement Managers, Bertram Day & Co., Ltd., 9 and 10, Charing Cross, S.W.1.

Telephone No.: Gerrard 8063 and 8064.

SUBSCRIPTION RATES.

28s. per annum, post free. Single Copies 6d., or post free 7d.

Registered at the G.P.O. for transmission by Magazine Post to Canada and Newfoundland.

The London Telegraph Training College, Ltd.

Telephone: WESTERN 2696.

Morse House, Earl's Court, S.W.

ESTABLISHED 25 YEARS.

OFFICIALLY RECOGNISED BY THE WAR OFFICE AND POST OFFICE AUTHORITIES
CABLE AND WIRELESS TELEGRAPHY.

PARENTS desirous of placing their sons in either of the above Services and of affording them the best training facilities should apply for particulars of Courses and the methods of instruction which place this Institution in the first rank. Cable Telegraphy offers at the present time excellent prospects to youths from 15 years of age and upwards, and the College has exclusive facilities for obtaining posts for qualified students in the leading Cable Companies at commencing salaries of £150 to £300 per annum, with yearly increments of £12 to £25, and ultimate possibilities of obtaining positions as Supervisors, Assistant Superintendents, Managers, etc.

In the Wireless Telegraph Service the commencing remuneration at the present time is approximately £150 per annum, and Operators, when qualified by obtaining the Postmaster-General's Certificate of Proficiency, are nominated by the College for appointments. No Correspondence Classes or Branches.

DAY AND EVENING CLASSES.

Prospectus containing all information will be forwarded on application to THE SECRETARY (DEPT. H.), 262, Earl's Court Road, Earl's Court, London, S.W.5.

Sole Proprietors of the "Scott" Training Disc, which contains useful formulæ and other information for Wireless Telegraph Operators and is invaluable to Army Signalling Officers for range finding, etc.

Price, complete with instructions for use, 1/- Postage 2d.

VALVES

DELIVERY FROM STOCK.

RECEIVING.



Type.	Filament Voltage.	Anode Voltage.	PRICE.
R	4	60	£0 17 6
R ₄ B	4	50	1 10 0
V ₂₄	5.2	36	1 4 0
Q	5.2	50	1 4 0
		(150 as amplifier)	
QX	5.2	50	1 4 0

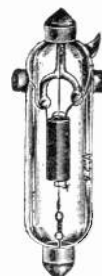

SPECIAL LOW TEMPERATURE VALVES.

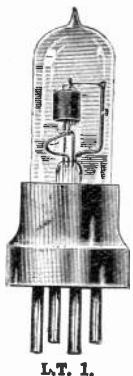

Type.	Filament Voltage.	Filament Current.	Anode Voltage.	PRICE.
L.T. 1	1.8	.4	36-50	£2 10 0
L.T. 3	1.8	.11	„	„

TRANSMITTING.

Type	Filament Voltage.	Anode Voltage.	PRICE.
A.T. 25	5.5	UP TO 1,000	£1 10 0
A.T. 40X	7	„ 1,000	2 15 0

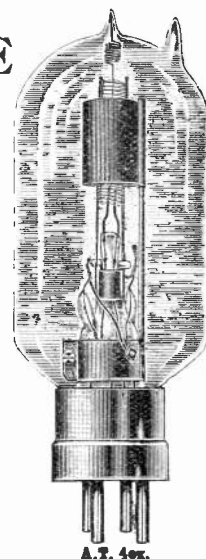

THE
MARCONI SCIENTIFIC INSTRUMENT CO., LTD.

40 DEAN STREET, SOHO, W.1

TELEGRAMS: THEMASINCO, WESTCENT
 TELEPHONE: GERRARD 7744

How did YOU receive the Election Results?

It can be confidently said that all who were listening in with a Wates Set were very pleased with the reception when the election results were broadcasted.

The reception was good—not only because Wates Sets are perfect in manufacture, but also because purchasers can avail themselves of the free advice of our technical experts, who can help them to get the best possible results under varying circumstances.

Not only do we manufacture complete Receiving Sets of the best quality, but also all component parts.

The illustration is that of the PYRAMID H.T. Battery, which we can confidently recommend to help you to get better results. It is priced as follows:—

Filament Resistances	3/9
"Ideal" Valve Accumulator—	
4-Volt 50 amp. - (Carriage 2/-)	25/-
6 ,, 50 amp. - (Carriage 3/-)	35/-
Variable Condensers (of various capacities) From	6/-
Fixed Condensers. From	2/6
3-Coil Holder, complete Unit for use with Standard Coils - -	20/-

15-Volt 3/6

30-Volt 7/6

With variable plug connection.

Send 3d. stamps for our Illustrated Catalogue.

List of H.T. Batteries & Accessories—Free.

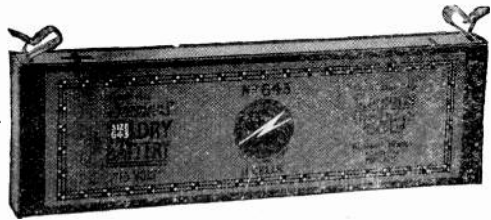

WATES BROS., 13-14, Gt. Queen St., KINGSWAY, LONDON, W.C.2.

J. BURNS, LTD.
Wangye Works,
Chadwell Heath, Essex.

We are actual manufacturers and can offer special advantages to the trade—send us your enquiries.

CONDENSERS.	retail price
.001 mfd.	16/- ca.
.0005 ,,	12/6 ca.
.0003 ,,	11/6 ca.
.00005 ,,	5/6 ca.
Filament Resistances	3/- ca.
Terminals with high base	1/6 doz.
Contact Studs, with nuts	9d. doz.
Sliders, with springs and studs	9d. ca.
Ebonite Panels, cut to order	3/6 lb.

Single Valve Panels

fitted with Variable Condenser, Filament Resistance, Grid Leak and fixed Condenser, Engraved Panel and Rosewood finished Box, ready for use

£4

Vulcanised Fibre and Ebonite Sheets, Rods & Tubes from stock.

EBONITE AND VULCANITE

TUBES—RODS—SHEETS

LARGE STOCKS

BRITANNIA RUBBER AND KAMPTULICON CO., LTD.

7, NEWGATE ST., LONDON, E.C.1

Telephone : 2168 Central

Telegrams : Britannia, London

THE WIRELESS WORLD AND RADIO REVIEW

THE OFFICIAL ORGAN OF THE WIRELESS SOCIETY OF LONDON

No. 172 [No. 9.
VOL. XI.] DECEMBER 2ND, 1922.

WEEKLY

Conversion of the Townshend Wavemeter

EXTENSION OF RANGE TO SHORT WAVELENGTHS

By B. E. ALSTON.

THIS article is intended to be of use to those amateurs who possess a Townshend Wavemeter. The normal range of this instrument is from 4,000 to 300 metres. This is effected by (1) plugging in an extra condenser across the condenser which is in parallel with the variometer, and (2) by switching the variometer coils in series or in parallel. Now, if a switch could be provided to cut out the existing condenser across the variometer, then the instrument would give much lower readings. This

with four wires connected to one end of it. These four wires are disconnected from the condenser, soldered together, and a lead from the join taken to one of the right-hand plug

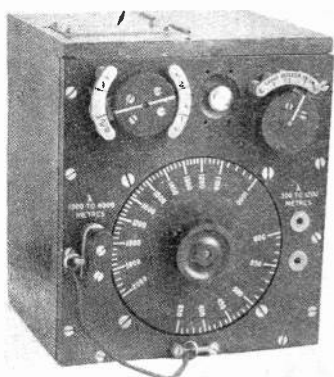

The Townshend Wavemeter.

can be done by using the right-hand plug sockets. In the diagram overleaf, figure (a), will be seen the front condenser (the one permanently across the variometer)

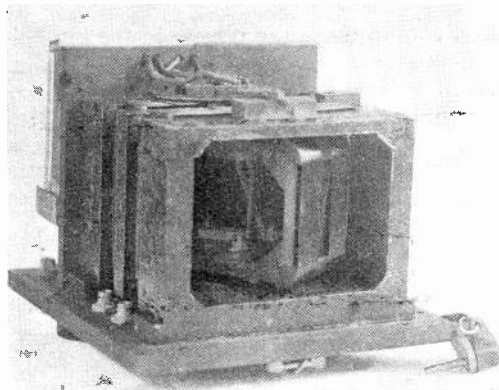

Interior, showing Variometer.

sockets. The condenser terminal is then connected by a lead to the other plug socket. Then, when the plug is in the sockets, the condenser is in circuit and everything as originally arranged. If the plug is left out however, the condenser is disconnected, and the instrument will read down to about 90 metres. This rearrangement is shown in figure (b). A rough calibration chart is given. This will be approximately constant for all instruments, due to their standardised manufacture.

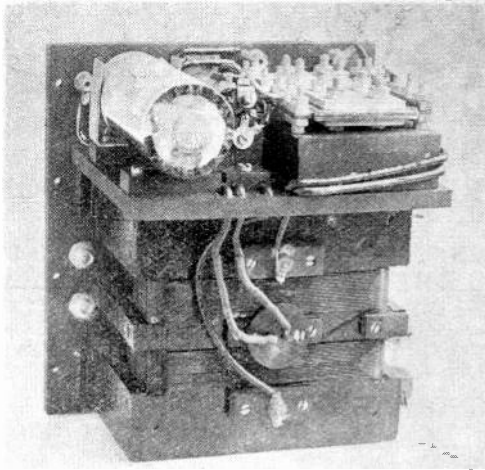

Interior view from the back, showing variometer stationary winding, cell, buzzer, and fixed value condensers. The sockets on the left are those to which leads are joined in converting the wavemeter for use on short wavelengths.

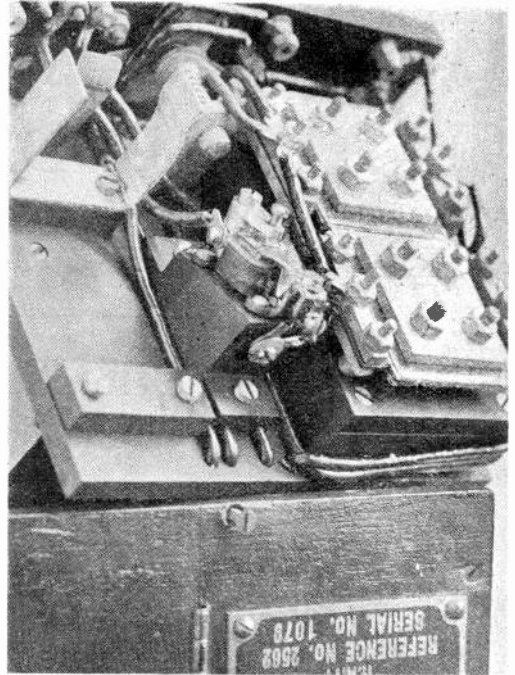

The upper condenser on the right-hand side carries the four leads.

Of course, when the plug is in the left-hand sockets—for the higher wavelengths—a short-circuiting plug should be left in the right-hand sockets to put the condenser in circuit, otherwise all the readings above 1,000 metres will be incorrect. The instrument was calibrated against a Sullivan Wavemeter for the 300-100 metres range.

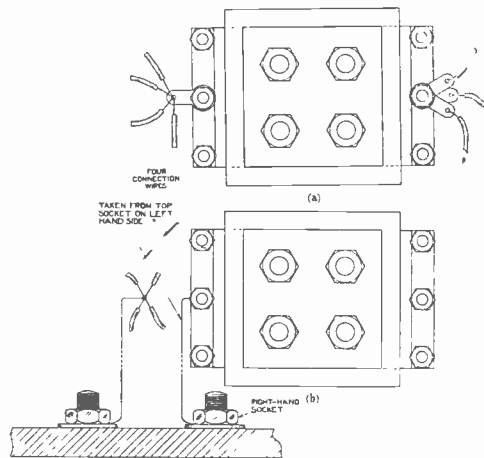

Method of transferring the condenser connections.

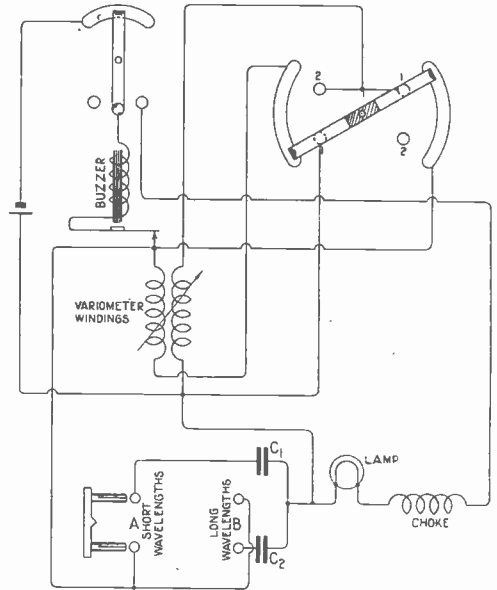

Circuit diagram of the Converted Wavemeter.

Wavelength.	Switch.	Scale reading.
300 m.	} 2	570
275 m.		525
250 m.		480
225 m.		420
200 m.		360
175 m.	} 1	580
150 m.		500
125 m.		460
100 m.		420

A calibration curve can be drawn from these figures and preferably fixed on the back of the instrument and varnished over to preserve.

Revolving Coil Holder

A Device for Rapidly Changing Tuning Coils.

The coil holder, designed from a principle suggested by Mr. W. Lee, provides a very convenient method for rapidly interchanging tuning inductances and also varying the extent of coupling. Referring to the adjoining diagram, the coils are carried in the mounts which are held between ebonite plates, the lower one having on the under side, metal segments. These segments are cut from a plate, screwed or pinned and soldered to the ebonite.

The coil holders and plates are held down to a base by means of a spindle and spring washer, so that spring contacts, similar in pattern to those adopted in bayonet type lamp holders recessed in the base, may make reliable contact with the segments.

The fixed inductance to which the revolving coils are coupled is arranged on the base so that minimum coupling is provided as soon as the contacts throw the movable coil in circuit. Further turning of the knob then tightens the coupling to the required degree. Critical coupling may be effected by arranging limited movement to the coil attached to the base and operated through reduction gearing. Better still perhaps, is to clamp a toothed wheel of a slightly larger diameter than the top plate, under the spring washer, so that it only has a friction grip on the plate, the friction being insufficient to hold the plate when the wheel is locked, yet when the wheel is turned

by a small pinion the plate also revolves. With a few modifications, the driving wheel for critical adjustment may be mounted below the coil holders to facilitate the setting up of the small pinion or worm wheel with its spindle.

Two rotating holders, each designed to carry four or more coils assembled side by side, can be employed for rapidly changing the

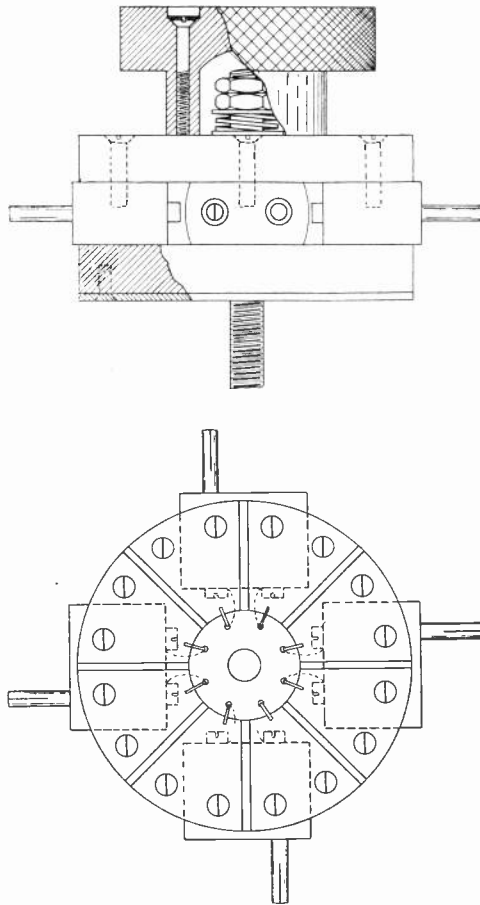

inductance coils in circuit in a tuner or receiver, the coils and holders being inside the instrument, one having a spindle extended on to the front of the panel. If it is desired that both revolving holders shall turn together, they may be fitted with toothed wheels, and coupled together with a third wheel, to which is fitted the operating spindle and knob.

The Johnsen-Rahbek Loud Speaking Amplifier.

By S. G. CROWDER, GRAD. I.E.E.

FOR the benefit of amateurs who wish to utilise the tremendous degree of amplification offered by a suitable design of loud speaker, employing the principle of the electrostatic adhesive effect of metal and mineral, a description here of a cheap, efficient and easily made instrument will not be amiss.

This adhesive effect due to the Danish engineers, Johnsen and Rahbek, and whose apparatus was demonstrated at the Institution of Electrical Engineers some time ago, has been fully described by Mr. P. R. Coursey in his articles on "Loud Speaking Telephones."*

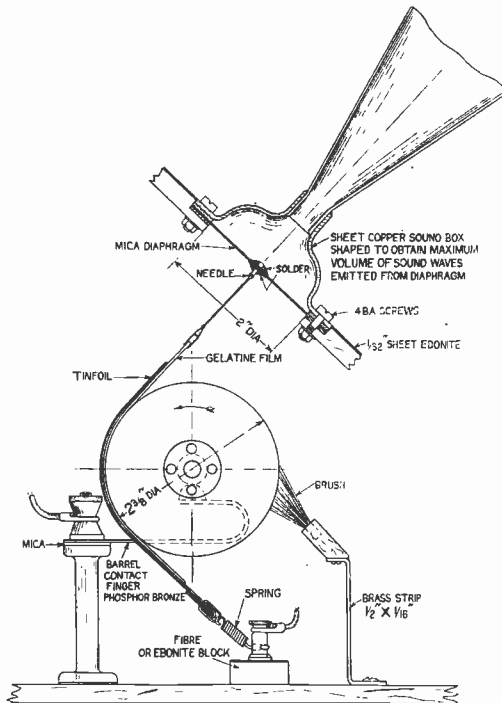

Fig. 1. Details of drum, band and diaphragm.

A recent article in this journal by Mr. F. H. Haynes† described an arrangement whereby

* *Wireless World*, Vol. IX., pp. 225, 256, 289, 311, 371.

† *Wireless World and Radio Review*, Vol. X., p. 159.

agate was used in the construction of the cylinder, which is, of course, an ideal proposition, but it is likely to become rather expensive to the bulk of amateurs.

I will therefore endeavour to give a description of a comparatively cheap loud-speaking amplifier which I have made, giving excellent results. The cylinder in this instance is of brass and made up of No. 14 S.W.G. tube sweated on to two end flanges forming spigots and the whole turned up in the lathe dead true as shown in Fig. 2. It is of course

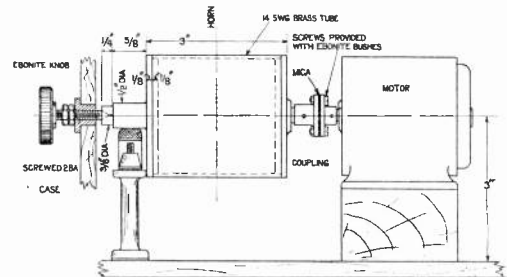

Fig. 2. Method of driving cylinder.

essential that the surface of the cylinder be absolutely free from blemishes or scratches, and should be highly polished. One end of this cylinder is supported and revolves in an adjustable gimbal bearing, to minimise friction, and the other end direct coupled to a small electric motor, provided with a variable resistance. Care must be taken to properly insulate the coupling by a disc of ebonite. The barrel and motor are centred and properly aligned, the latter being fixed to the base by a small block of wood.

The semi-conductor in this case is flexible gelatine film cut from an ordinary developed photographic film, $2\frac{1}{2}$ in. wide by about 4 in. long, with the "image" side removed if desired with hot water. This is coated on the outer surface by a metallic electrode made from two or three sheets of "condenser" tinfoil, free from pinholes, cut to within $\frac{1}{8}$ in. of each edge of film, laid together and ironed flat and smooth and fixed to the film with amyl acetate solution (Fig. 3).

One end of this band is now joined by a thread of twisted silk or catgut to a round diaphragm made up from a disc $2\frac{3}{8}$ in. diameter,

of clear ruby mica wedged between two metal rings. In the centre of the disc is fixed a sewing needle with moderate size eye, cut down to about $\frac{3}{8}$ in.; this is inserted into a hole bored in the disc. A small copper foil washer is placed on each side of the disc round the needle, and a blob of solder dropped over it, as shown in Fig. 1.

After securing one end of the band by the thread to the needle, the band itself is wrapped round a portion of the periphery of the cylinder, gelatine in contact with the brass, and secured at the other end by two light wire springs to maintain band in tension, and to allow for the electrostatic friction caused by the difference of potential between band and cylinder. These springs may be conveniently connected to input terminals for the polarising voltage. As it is essential to keep the cylinder free from

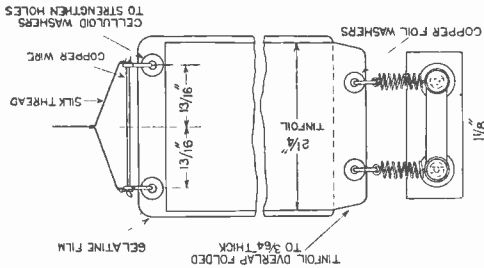

Fig. 3. The friction band showing method of attaching the ends.

dust of any sort, a brush should be provided to bear on the surface as it rotates. This can be conveniently made from several camel hair brushes, the hairs being extracted and arranged flat and glued into a slotted wooden support, inclined to the sides of cylinder, the brush being slightly less in length than the latter.

The contact finger for the polarising voltage to the cylinder is made from a phosphor bronze strip 4 in. by $\frac{1}{2}$ in. to one end of which is soldered a small pad of copper gauze, curved on the surface and smoothed off with a file. This end is bent as shown in Fig. 1 to form a springy contact on to the shaft of the cylinder to ensure constant contact. The opposite end is drilled and secured by a nut and terminal on a small brass pedestal. The whole is then mounted inside a suitable case, which can be made quite cheaply, the shape being left to individual taste, providing the band covers a fair portion of the surface of the barrel. The diaphragm itself is fitted in

the top of the case over which is mounted a small gramophone horn, having a suitable flange on the narrow end. Fixing the horn is effected by passing four 4 BA screws through the flange and diaphragm rings.

In the instrument described the diaphragm and horn are mounted on a removable sliding

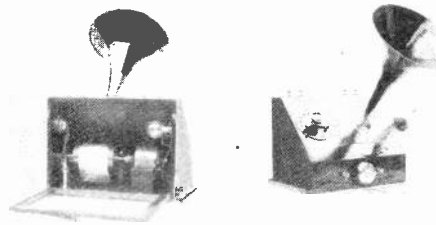

Fig. 4. The complete Loud Speaker.

panel, thus enabling the apparatus to be used to record signals on a moving tape, by attaching a thread, which originally moved the diaphragm to a syphon recorder.

Fig. 4 is a photograph of the finished instrument fitted with a selector switch used as a potentiometer regulator for the motor.

The brass tube seen projecting from the front of the instrument is purely an experimental addition, in an unfinished state, to record photographically, both telephonic and telegraphic impulses. Suitable terminals are provided for connection to microphone or step-up transformers. A 1 in. spark coil was utilised to perform the functions of the

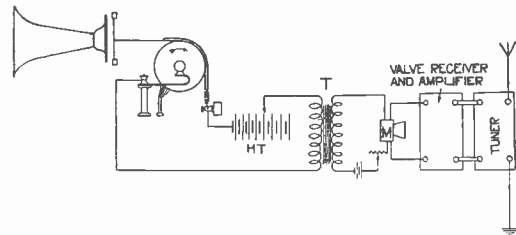

Fig. 5. Circuit of loud speaker. M is a microphone relay or receiver coupled to microphone.

latter, the contacts being screwed tight; tumbler switch and terminals for motor are also provided.

The back of the case is provided with a hinged glass door, for easy access and inspection of the instrument while in operation.

The suitable circuit is shown in Fig. 5.

The polarising voltage in this instance is derived from the usual H.T. battery supplying the anode voltage to the valves.

Electrons, Electric Waves, and Wireless Telephony—IX.

By DR. J. A. FLEMING, F.R.S.

The articles appearing under the above title are a reproduction with some additions of the Christmas Lectures on Electric Waves and Wireless Telephony given by Dr. J. A. Fleming, F.R.S., at the Royal Institution, London, in December and January, 1921-1922. The Wireless Press, Ltd., has been able to secure the serial rights of publication, and any subsequent re-publication. The articles are therefore copyright, and rights of publication and reproduction are strictly reserved.

7.—ELECTROMAGNETIC RADIATION AND THE QUANTUM THEORY.

Before we can proceed to explain the manner in which the vibrations of electrons, atomic nuclei and atoms or molecules give rise to a vast gamut of electromagnetic waves stretching from the shortest X-rays up to the longest known dark heat rays, and beyond these the Hertzian and the wireless waves, we shall have to attempt the task of elucidating the nature of the so-called Quantum Theory or hypothesis introduced into physics by Professor Max Planck about the year 1901, which has opened a new chapter in the development of physical ideas.

It will be necessary to preface explanations by some definitions of terms and words used in the science of mechanics.

An important physical conception is that of *Energy*. Energy is defined as the ability to do *Work*, and this last is a technical term meaning the displacement of a material substance against some force which resists that displacement. Thus, if we lift up a weight against the force of gravity, we do work in this sense of the word. The work is measured by the product of the displacement and the force, each reckoned in certain consistent units. Thus if we lift up a mass weighing 10 lbs. to a height of 10 feet, we do work against gravity to the extent of 10×10 *foot-pounds*. The time taken in doing the work does not affect its numerical value. Thus in the above example the work done is 100 foot-lbs., whether the mass is lifted very slowly or very quickly. When the substance has been so lifted up against the force of gravity it is said to have potential energy or energy of position to the extent of 100 foot-lbs.

There are many ways in which such potential energy can be accumulated. For instance, by bending or stretching a spring, by pumping

up water to an elevated cistern, or electrically, by charging with electricity a condenser or Leyden Jar. In all cases the work or energy is measured by the product of two factors, viz., a displacement and a force, a quantity of water and a height through which it is lifted, or a quantity of electricity and the mean potential to which it is raised.

The rate at which work is done is called *Power*. Thus, if we lift up a mass of 550 pounds weight a height of one foot in one second, we do work of 550 foot pounds at a rate called *One Horse Power*, which, however, has nothing to do with a horse.

Energy also can exist in the form of a mass in motion or some equivalent. In this case it is called *Kinetic or Motional Energy*. It is then measured by half the product of the mass and the square of its velocity.

The reason for this is as follows:—

Force is defined as any agency which changes the momentum of a body. The momentum is defined as the product of the mass and the velocity. The force is measured by the rate at which it changes momentum or by the momentum added per second.

Thus if a body of mass m grams has a velocity denoted by v_1 centimetres per second and after a short time t seconds, during which it is acted upon by a force f , acquires a velocity v_2 , then the force f is measured by the difference $(mv_2 - mv_1)/t$, because this is the time rate of change of its momentum. During this time its velocity has changed from v_1 to v_2 and if this has taken place uniformly, the distance or space moved over by the body is $\frac{1}{2}(v_1 + v_2) \times t$. The work done is then the product of force and displacement or is

$$W = \frac{(mv_2 - mv_1)}{t} \times \frac{(v_2 + v_1)}{2} \times t = \frac{1}{2}mv_2^2 - \frac{1}{2}mv_1^2$$

This shows that the work done on a mass m in increasing its velocity from v_1 to v_2 is the change in the quantity $\frac{1}{2}mv^2 = T$, called the kinetic energy.

The above statement may be regarded as valid in accordance with Newton's Laws of Motion and his doctrine of absolute space and time. The searching analysis to which the ideas of space, time, and motion have been submitted by Einstein and his followers have, however, shown the necessity for modification in our fundamental conceptions. The basis on which these new views have arisen was the inference made from the experiments of Michelson and Morley, and from other observations, which demonstrated clearly that the velocity of a ray of light is independent of the motion of the source of light or of the observer, and in fact is the same for every frame of reference. The velocity of light is therefore a fundamental constant of nature. It is always and everywhere 300,000 kilometres per second or very close thereto. We denote this velocity by the letter c .

Experience also shows us that our statements about the facts of nature have in general identical form whether we refer them to one frame of reference or to another in uniform relative motion with respect to it. Thus, if a scientific man had a laboratory on board a ship and made measurements of the time of vibration of a certain pendulum or the space fallen through in one second by a released ball, he would find exactly the same numerical results whether the ship was at rest in harbour or moving smoothly and uniformly over the sea at any speed. This is called by Einstein the *restricted principle of relativity*.

In accordance with this theory, which, however, is by no means universally accepted, it can be shown that the kinetic energy of a mass m moving uniformly with a velocity v should be given by the expression

$$mc^2 \left(1 - \frac{v^2}{c^2} \right)^{-\frac{1}{2}}$$

where c is the constant velocity

of light. If v is small compared with c the energy is equal to $mc^2 + \frac{1}{2}mv^2$. Hence we see that even if a mass is at rest with reference to a certain frame of reference it is not therefore destitute of kinetic energy.

Furthermore, it can be shown that if an amount of energy E in the form, say, of heat is given to a body of mass m without altering its

velocity of translational motion v , its energy is increased by an amount $\frac{E}{\left(1 - \frac{v^2}{c^2}\right)^{-\frac{1}{2}}}$, and

therefore its total energy is expressible as—

$$\frac{\left(m + \frac{E}{c^2}\right)c^2}{\sqrt{1 - v^2/c^2}}$$

This implies that the apparent mass m is increased by an amount E/c^2 by the addition of the energy E . This seems to suggest that what we call the mass of a body is only a manifestation of energy of a certain kind, possibly some form of spinning or rotational energy, and that the indestructibility of Energy and of Matter are only two different aspects of the same fact.

As long as the velocity of translation of a mass is small compared with that of light the increase in its kinetic energy, which results from giving it a velocity v , is expressed by $\frac{1}{2}mv^2 = T$, and this, in ordinary classical theory, is taken to be its kinetic energy, although the theory of Relativity shows that it is not the whole of it. There is in addition, in connection with a mass m a concealed or latent kinetic energy measured by mc^2 , even when that body is at rest with respect to the framework of reference considered.

Suppose then that a massive body like a planet is moving along a certain path with a certain kinetic energy at each point. Let us suppose the path divided up into little elements of length, each denoted by the symbol ds , and let each element of length be described in a short time, denoted by dt . Then the velocity of the body in each little stage is measured by the quotient ds/dt and the

kinetic energy by $\frac{1}{2}m \left(\frac{ds}{dt}\right)^2$, if we call the mass m .

If we multiply the mean kinetic energy during each element of motion by the time dt taken to describe it, we obtain the product

$$\frac{1}{2}m \left(\frac{ds}{dt}\right)^2 dt \text{ or } \frac{1}{2}m \frac{ds}{dt} ds \text{ or } \frac{1}{2}m v ds.$$

If we obtain these products for each little element of the path and then add them all together or integrate over the whole path, we obtain a result called the *Action* of the body.

It appears that there is a certain kind of equivalence between the product of a small quantity of energy stored up or existing for a long time, and that of a larger quantity of energy for a relatively shorter time, provided the product of energy and time of action is constant.

What may be called the value of the energy for physical purposes or the opportunity of using or transforming a certain amount of this energy is not merely measured by its numerical amount, but by the product of its amount and the time it is available.

Thus, to give an analogy, there is a certain sense in which a small salary guaranteed for a number of years may be the equivalent of a larger salary guaranteed only for a lesser time, viz., when the product of salary and years is the same in each case. It appears then that in physical phenomena and changes the all important matter is the totality of the Action. In a large class of physical phenomena the spontaneous operations always take place in nature in such a manner that the Action expended is the least possible.

This principle of Least Action is of very wide application in dynamics. Thus, a planet moves in its orbit round the sun along a path such that the Action in going from one point to another is the least possible. There is a corresponding principle of Least Time in optics. A ray of light moves through a medium with a velocity which is inversely as the index of refraction (denoted by μ) of that medium. Hence the time of travelling over an element of path ds is the product μds . The path of a ray of light through a series of transparent media is always such as to make the sum of the elementary products μds a minimum.

The important innovation introduced by Planck in 1901, in connection with radiation phenomena, was the idea that Action is discrete in nature and that there exists what may be called an *atom of action*, or least possible indivisible amount of it.

We cannot explain why this should be the case. We have seen that electricity is also atomic in structure and that there exists an atom of electricity called the electron, equal to 4.77×10^{-10} of an electrostatic unit or to 16×10^{-20} of a coulomb or ampere-second, which is indivisible. All charges of electricity must be in integer multiples of this electron unit. We can have them in millions or billions, but we cannot have a fraction of a unit or of an electron.

In the same way Planck has shown that radiation of energy can only take place in integer multiples of a very small unit of Action which is equal to 6.547×10^{-27} erg-seconds. This

means $\frac{6547}{10^{30}}$ of an erg of energy lasting for one second or one erg lasting for the same fraction of a second. The reader may be reminded that one erg is the work done when a force of one dyne acts through a distance of one centimetre.

The *weight* of a mass of one gram is nearly 981 dynes. The above unit of action is an extremely small one and we need take no account of the atomicity of action in large scale dynamics, but only when we are dealing with atoms singly.

Planck has particularly applied this view of the atomicity of action to the discussion of the problem of radiation of electromagnetic waves by electrons and atoms. When a solid body, say, a mass of carbon or metal, is raised to a high temperature, its atoms and electrons are thrown into a state of rapid vibration. Planck calls these vibrators oscillators.

If we consider a single electron moving to and fro along a straight line with a vibratory motion, we see that its velocity is changing at every instant, and therefore in accordance with explanations already given, the electron is sending out vibrations along its electric lines or lines of electric force; in other words it is radiating energy. It is very easy to prove that in the case of an electron oscillating in one line like the bob of a long pendulum, the Action in one period is the product of the mean energy of motion and the periodic time. Also that the energy radiated per period is a definite fraction of the oscillating energy. If T is the time of one complete vibration, and if in that time an amount of energy denoted by E is radiated, then the Action is the product of E and T reckoned in ergs and seconds.

Planck then says that the product of E and T , or $E \times T$, must be an exact integer multiple of the unit of action which is denoted by h ($= 6.55 \times 10^{-27}$ erg-seconds). Therefore we have the equation $ET = mh$ where m is some integer. But if the frequency of the oscillations or number per second is n , then $n = 1/T$ and $E = mn h$. Accordingly, radiation of energy appears to take place in integer multiples of a unit of energy equal to the product nh . This unit is called a *Quantum* and is denoted by the Greek letter ϵ .

Planck's fundamental equation is then

$$\epsilon = nh.$$

The reader should carefully notice that the magnitude of this quantum of energy (ϵ) is not constant but is proportional to the frequency n . It is the atom or element of Action denoted by h which is invariable in magnitude.

The upshot of all the above is as follows: If there are a number of little oscillators or vibrating electrons which vibrate with different frequencies, like pendulums of different lengths, some moving fast and some slow, or with high frequency and low frequency, then each of these electric oscillators is radiating energy but they can only radiate this energy in whole quanta and the size of the quantum radiated in each case is proportional to the frequency.

In an incandescent body the electrons and atoms which constitute the oscillators, do not all possess the same energy of vibration, any more than the molecules of a gas have the same velocity. The speeds of the gas molecules and also the energies of the oscillators are distributed according to Maxwell's law, as already explained, and according to a similar law the energy is distributed between oscillators having the same frequency.

Let us consider then the condition of things in a mass of incandescent metal or carbon. We have atoms and electrons which can vibrate in very various periods depending on their mass and the elastic constraint to which they are subjected by the attractions and repulsions of neighbouring electrons. Moreover they are vibrating with different amplitudes, or in other words have different amounts of energy associated with them. We may, in imagination, divide these oscillators into groups arranged progressively according to the frequency of their oscillations, and each group of similar frequency may be considered as divided into sub-groups, which have similar amounts of oscillatory energy, but the sub-groups arranged in order of increasing energy content. Each of these oscillators is sending out electromagnetic waves of identical frequency and of various amplitudes. This electric radiation constitutes the light, heat and actinic radiation of the incandescent body. If then we send a thin beam of this radiation through a prism or defraction grating, these rays of different frequencies are differently refracted and spread out into a spectrum when received on a screen.

As regards those waves, the wavelengths of which lie between 0.395μ and 0.76μ , or, say,

$3,950$ Angström units to $7,600$ A.U., these have the power of stimulating the retina of our eyes and exciting the sensation of light. the short waves creating a sensation of violet light and the larger red light. It is, however, well known that there is a range of ultra-violet light or invisible rays of wavelengths lying between about 250 A.U. and $4,000$ A.U., which can impress a photographic sensitive plate, but not our eyes. Again, there is a range of longer ultra-red or so-called dark heat rays, extending in wavelength from 0.8μ to about 300μ , all the waves in which cannot affect our eyes but can heat a sensitive thermometer.

Suppose then that we form a spectrum, that is, expand the complex many-frequency radiation from an incandescent body, such as the light and heat from an electric arc lamp or from the sun, into a spectrum or band of radiation, every strip of which is formed by waves of one particular wavelength. Let us place across this band a blackened platinum wire. This wire will absorb all the energy at that point and be heated thereby. We can determine the temperature of the wire by the increase in electric resistance that then takes place. So used this wire is called a bolometer wire and it enables us to measure the energy associated with the waves of each particular radiation from the least unto the greatest wavelength (see Fig. 46).

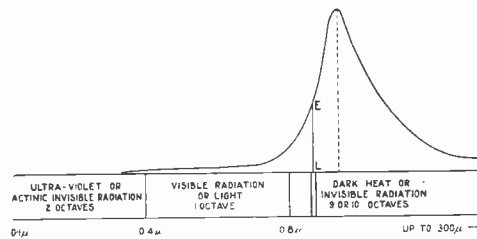

Fig. 46. Radiation energy curve for the spectrum of visible and invisible radiation. The height of the ordinate of the curve at any point is a measure of the energy of the radiation at that point.

When this measurement is made we find that the waves of very large wavelengths or very small frequency have little or no energy and that as the frequency increases the energy of radiation increases also, but not indefinitely. It increases up to a certain wavelength of maximum energy and then begins to fall off again, so that the waves of very high frequency have also small energy associated with them.

We can thus plot a radiation energy density

curve in terms of wavelength or frequency, as in Fig. 46.

When we attempt to account for this form of this curve, and especially for the fact that it has a maximum ordinate for a certain wavelength, difficulties are found. As long as we assume that energy can be radiated continuously, that is in any amount per second from each oscillator, theory shows that the radiation energy should increase rapidly with the frequency so that oscillators of high frequency should radiate very much more energy than those of low frequencies, whereas in the normal spectrum it is found that the waves of very high frequency have small energy as well as the waves of very low frequency.

Planck's theory of energy quanta was devised therefore originally to meet this difficulty and to enable a formula to be found which will express or predetermine the curve of radiation energy along the spectrum. This it has done very successfully.

He assumes, as we have seen, that energy is not radiated continuously by the oscillators, but comes out, so to speak, in gushes or quanta, the size of the quantum being in the case of every oscillator proportional to its frequency of oscillation or number of vibrations per second. Hence for the high frequency oscillators the quantum will be large and the probability that any particular oscillator or many such oscillators will have this amount of energy at disposal is small. Hence the total energy contribution of the high frequency oscillators is small. On the other hand, the quantum for the low frequency oscillators is small and therefore nearly every one is capable of giving it, but then, owing to the smallness of the unit, the total energy contribution is again small. But for oscillators of medium frequency the total contribution may be, and is, much larger. Hence we get for a certain wavelength a maximum energy radiation.

We might give an illustration as follows:—

Suppose that a collection was being made in a church or in a number of churches for some charitable object, say, hospitals. Imagine that in one church the clergyman announced that no person must give a donation of more or less than £5. The chance of there being many persons present who had that amount in their pockets and were willing to give it in one lump sum might be small and hence the total offertory would be small also, comprising perhaps only one or two such donations.

On the other hand, imagine that in another

church the minister announced that no person must put more or less than one penny in the plate. Nearly everyone would be able to give this coin, but the unit being small, the total offertory would again be small. If, however, an intermediate sum, say, one shilling or one half-crown, was announced as the sum which was to be the donation unit, a large number of the congregation would be able to give this amount and hence the total offertory would be much larger than in the extreme cases in which the unit of donation was either one penny or five pounds. By this ingenious idea Planck was able to find a formula which when represented graphically, exactly agrees with the experimentally determined curve of radiation energy distribution in the spectrum, and no one had previously been able to achieve this result.

Nevertheless, Planck's theory seems to necessitate certain assumptions which are rather forced. We have no proof that in an incandescent body there are oscillators of every possible frequency, in short, oscillators of an infinite number of frequencies. Also it is difficult to form any clear idea why Action should be atomic in structure unless Space and Time are also in discrete indivisible units.

In the spectrum there are, however, an infinite number of rays of different frequency and wavelength, extending from the longest dark heat rays yet observed of wavelength about 200 to 300 μ , to the shortest ultra-violet rays of about 0.1 μ in wavelength. Moreover, the spectrum may be said to extend to infinity in both directions, for beyond the longest dark heat waves we have the Hertzian and wireless waves to be considered in our next chapter, and beyond and below the shortest ultra-violet waves we have the X-ray waves.

A way out of this difficulty has, however, been suggested as follows: The process of radiation in an incandescent body probably consists in the creation of sudden groups of complex vibrations of finite duration, caused by the impact of electrons against atoms, and these last in turn are set in vibration as a whole and in their component electrons. These complex vibrations may by Fourier's theorem, already explained, be regarded as made up of a large group of simple harmonic vibrations each of different frequencies.

Since the complex groups of vibrations which can thus be analysed are not produced simultaneously and in step or phase or

absolute agreement with each other, we have in fact sent out from the incandescent body an infinite number of trains of complex vibrations which are built up of an infinite number of component harmonic vibrations and the prism or diffraction grating separates these out from one another and spaces them in order of wavelength or frequency in the observed spectrum of the radiation.

8.—ATOMIC ENERGY AND ITS RELEASE.

The previous explanations will have made it clear that the nucleus of the atom in which its gravitative mass chiefly resides is a structure which is probably built up of helium and hydrogen nuclei and of unnamed nuclei of mass three times that of the hydrogen nucleus, which are powerfully held together by negative electrons into a very compact mass. The helium nucleus in particular seems to be a very strong structure.

It appears that a very large amount of energy has to be put into the ultimate ingredients, viz., the positive and negative electrons, to bind them together in this extremely firm manner, so as to make a very small but exceedingly dense mass of matter about 10^{-12} or 10^{-13} of a centimetre in diameter. We might regard the nucleus as a sort of clock-spring which has been coiled up very tightly by the exertion of energy and then bound in some manner not easily released. If, however, certain kinds of atomic nuclei such as those of nitrogen are bombarded by α -particles,

the nucleus is disrupted and its approximate constituents, viz., helium and hydrogen nuclei, are flung out with great velocity.

This, and the phenomena of radio-activity, has suggested that we have in the nuclei of atoms an enormous store of energy which in some way we may be able to release.

At the present time, if we set on one side the not very large stores of water power which are often in very sparsely inhabited places, the chief sources of potential energies lie in the stores of coal and oil in the earth's crust. But the oil represents but a fraction of the energy stored up in the coal or to be obtained by burning the coal. Hence we may say that the chief source of power in the world is the potential energy of its stores of coal.

Nevertheless, the increasing cost of raising and transporting it, owing to the increase in the cost of labour, creates the hope that in some way the human race may be able to tap this almost illimitable store of atomic energy. The prospects, however, at present are not very bright. Such small achievements in direction which have been accomplished have required the expenditure of the expensive element radium.

Having regard to the fact that the atom is probably a wholly electrical structure, it may perhaps be possible to break it up by means of suitable high frequency electric oscillations to the study of which we shall next direct attention.

(To be continued.)

Inductance Coils for Short Wavelengths :

The Considerations for Good Design.

THE aim when building an inductance coil is to procure a maximum of inductance with a minimum of self-capacity and resistance. These two latter qualities are unnecessary for the operation of the coil, and are properties of the coil by accident. Since it is desirable that the properties of a circuit (capacity, inductance and resistance) be under the control of the experimenter, that coil which possesses least self-capacity and resistance is the better coil, as the following considerations will show.

The self-capacity of the coil may be considered as in parallel with the coil. The combination then has a natural wavelength, determined by the magnitude of the L and C of the coil.

When a tuning condenser is joined across the inductance, the self-capacity is added to that of the tuning condenser. With the condenser set at its maximum value, the addition of the coil capacity is not of much account in producing a longer wavelength, since it forms but a small proportion of the capacity in the circuit. When, however,

the tuning condenser is set near its minimum value, the self-capacity of the coil forms a large percentage of the total capacity in the circuit, and it cannot be neglected. If the self-capacity, and the capacity of the condenser are equal, the wavelength is 1.4 times that which it would be if no self-capacity were present. The tuning range of the coil and variable condenser has therefore suffered reduction, which is a serious matter, as more coils are required to cover the wavelength range.

Another harmful effect is manifest when the coil is in series with an E.M.F. A smaller current will flow in the coil than if the same E.M.F. were set up by induction from a neighbouring coil. The apparent resistance has increased. The apparent inductance will likewise change when the frequency of the E.M.F. changes.

In practice coils are often provided with tappings for convenience. The portion of the coil not in use, however, is still influenced by the field set up by the remainder. If the frequency of the circuit of which a section of the coil forms part, is high, a considerable amount of energy may be absorbed in the unused portion, especially so if its natural period is close to that of the energising circuit. Further, the circuit may possess several natural frequencies, which to be sure is quite undesirable when we are receiving signals, as it would not be possible to tune out signals with wavelengths near that of the one desired.

Self-capacity and resistance are therefore definitely harmful. They can be reduced by careful design.

The former upon which the wire is wound should be perfectly dry, and no more material than is necessary for mechanical support should be used. Cardboard should be avoided. Big claims have been made for the use of Litzendraht. It has been shown that high frequency resistance of a well constructed coil of Litzendraht is greater at 300 metres than for a similar coil of ordinary D.C.C. copper wire. Litzendraht is difficult to handle and to solder. If the whole of the strands are not continuous, through damage to the wire, or poor soldering, the direct current resistance will exceed that of a similar length and area of solid wire. Furthermore, a few disconnected strands enormously increase the self-capacity and high frequency resistance of the coil. Coils constructed of this wire often change their characteristics for the

worse after being in service for a time. The fine strands, often made brittle while being cleaned preparatory to soldering, are apt to break off at the soldered connection during the life of the coil.

Solid copper wire is cheaper to purchase than Litzendraht, but the experimenter may fear no inferior results if the following points are borne in mind.

The copper wire should have a covering of double cotton and be of heavy gauge, consistent with the dimensions of the coil. No. 20 or 22 is suitable for short wave aerial coils. The double cotton covering ensures good spacing between turns. The coil when wound must be thoroughly dried in an oven, and then impregnated with paraffin wax or shellac. The function of the wax or shellac is to prevent the absorption of moisture by the cotton, and any excess over the quantity required for this serves no useful purpose, but increases the losses and self-capacity.

The end connections should be brought straight out from the coil, and not be brought out from the same end.

Coils should be broken up into sections to minimise dead-end losses, or better still, a number of coils should be made for use with different wave ranges.

The self-capacity of a coil is independent of its length. The inductance of a coil, containing a given length of wire, is a maximum when the diameter is 2.45 times its length, although this ratio may be considerably departed from without serious change in the ratio length of wire to inductance.

W. J.

ADJUSTABLE HEADBAND.

The accompanying figure shows a device for giving adjustment to headgear telephone receivers, in order that they may fit tightly and comfortably to the ears. The headband consists of two covered spring pieces, terminating on plates which make friction contact with the stems which carry the receivers, thus avoiding screws which are liable to become entangled with the hair.

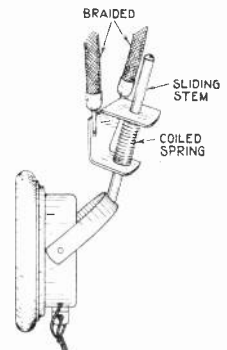

An adjustable headband made by the Automatic Telephone Manufacturing Co., Ltd.

A Syphon Recorder of Simple Design.

By W. WINKLER

THE syphon recorder which it is proposed to describe in the following article will no doubt appeal to amateurs on account of its simplicity of construction which is at the same time combined with a high degree of efficiency. This may be gauged from the specimens of records which are given in illustration of its capabilities (Fig. 1).

The cost of this recorder is trifling, since almost everything required for its construction is already in the possession of almost every amateur.

At the present time there is ample scope for experiment in the reception of high speed transmissions since so many of the high power

The principle consists in the employment of a Brown telephone ("A" Type) with an extension arm fitted to the reed as shown in Fig. 3 to form a relay. The telephone is operated directly by the signals from the receiver. Each dot or dash gives a short or long buzz at this relay, thus causing a temporary increase in the average resistance at the relay contacts. This variation in the resistance at the relay contacts is sufficient to serve our purpose and is much more easily obtained than a definite make or break contact. To eliminate sparking, a 200-ohm non-inductive resistance is shunted across the contacts of the relay.

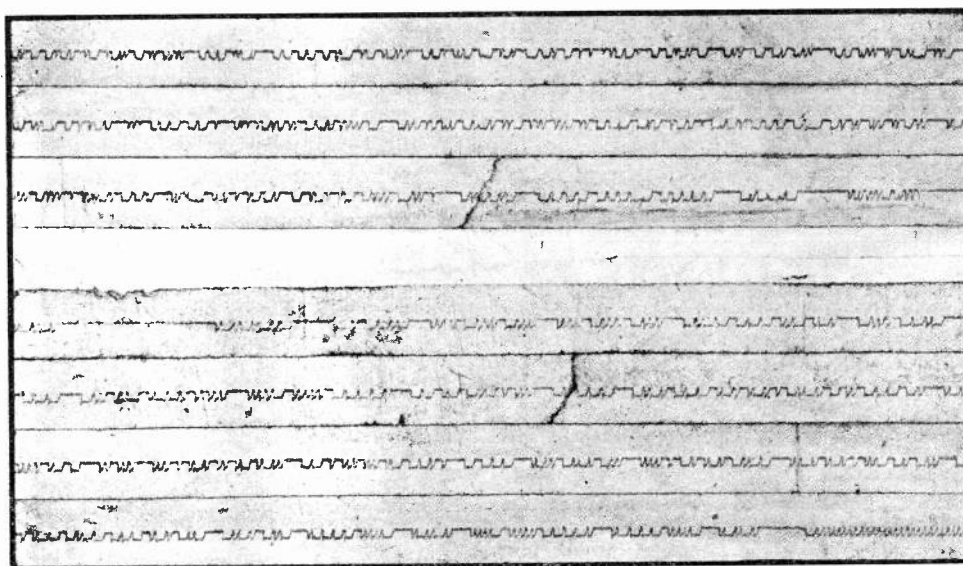

Fig. 1 Specimens of Tape taken with the Recorder.

stations now conduct their traffic by automatic systems.

With this recorder and a three or four-valve receiver (or one or two valves and a Brown relay) good reproduction can be obtained from most of the high power European stations. At slow speeds such as 30 words a minute recording can be done with ease, whilst speeds up to 100 words a minute can be recorded with delicate adjustment.

The apparatus has been produced after a very considerable amount of experiment and the simplicity of the whole arrangement can be gathered from the photograph Fig. 2.

The pen movement is operated by the use of a Post Office buzzer magnet and a light steel armature fixed at one end arranged as on the average electric bell, bearing a short length of silver capillary tube (Fig. 3). This armature is normally under gentle but decided tension away from the pole ends.

The silver tube is held by means of solder to the armature and is shaped so that one end dips below the surface of the link in the pot (which is located as nearly over the axis of the armature as possible) and the other end rests on the paper strip at a perpendicular angle.

A second-hand gramophone motor is used as the motive power for drawing the paper tape, and guide pulleys are provided, that near the pen being adjustable for height so as to enable the pressure of the pen on the paper to be varied.

The method of operating the recorder is as follows.

The "Phone" relay is adjusted by setting the magnet position relative to the reed by the adjusting screw in the usual manner. Next the fixed contact on the relay is advanced until the circuit is *just* closed on "No signals." On the fineness of this adjustment depends the working of the instrument, and if set for

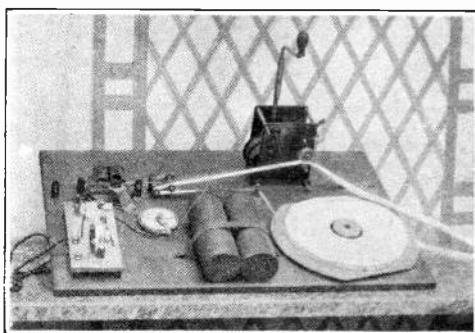

Fig. 2. The complete apparatus.

weak signals it will work well on strong signals, as these can always be reduced without trouble. The local circuit current (1.5 volts, 10-ohm magnet) is switched on and the armature is drawn over to the magnet poles.

As stated above, signals will cause vibrations at the contacts of the relay, thus reducing the current in the local circuit and releasing the armature. As soon as each signal ceases the armature and pen return to their normal positions, thus giving an undulating record of the received signals.

The extension fitted on the "Brown" phone reed is made of very thin brass sheet 0.003 ins. thick, bent U shape. This gives a light rigid arm, at the same time causing the naturally aperiodic reed to lose this quality. The result of this is that the recorder becomes most sensitive to a note of a certain pitch, and can be used with good results in spite of serious jamming, being able to pick out a note of one particular frequency.

It was found that an excursion of about 1/16 in. only, at the pen point was required to give clear readable signals.

An item which gave considerable trouble was the ink. One naturally wishes to have

an instrument which can be put into operation at a few moments notice. Morse inker ink was useless and ordinary inks dried in the pot and the pen, leaving an annoying sediment. The final effort yielded splendid results, and it has now been standing for 7 to 8 months and only requires the addition of a few drops of water occasionally. The mixture consists of 1½ ozs. glycerine and about as much Eosin as one can heap on a threepenny piece.

When the recorder is not in use a small empty pot should be left below the extremity of the pen, and the paper removed, as the pen will slowly syphon the ink from the pot, though only at the rate of about one drop in 24 hours.

It will be noticed that in operation this ink does not dry very rapidly on the tape, but this is no great disadvantage when one takes a little care.

The two dry cells of 1½ volts each shown in the photograph (Fig. 2) are not used in series. One acts merely as a stand-by and has not yet been used except during preliminary experiments. It was soon found to be quite unnecessary.

With the above remarks for guidance, a very efficient recorder can be made without any expensive or intricate material. It could be improved in several points of detail, as for

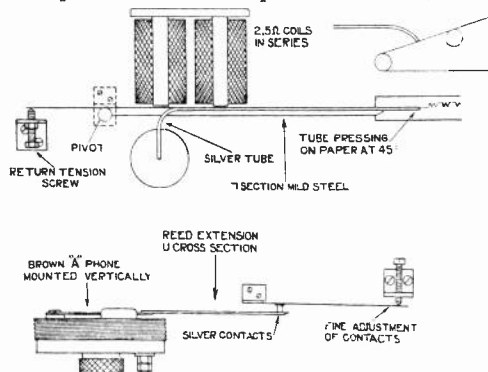

Fig. 3. Details of some of the parts.

example in the mounting of the phone relay, which should be much more rigid. When more time is available some of these improvements will be embodied. Many parts of the apparatus are just thrown together in order that one might make observations on their behaviour under different circumstances.

For the benefit of those who have not experienced it, I would mention that there is a great fascination in watching a pen recording Morse at a speed of, say, 100 words per minute.

Wireless Club Reports

NOTE.—Under this heading the Editor will be pleased to give publication to reports of the meetings of Wireless Clubs and Societies. Such reports should be submitted without covering letter and worded as concisely as possible, the Editor reserving the right to edit and curtail the reports if necessary. The Editor will be pleased to consider for publication papers read before Societies. An Asterisk denotes affiliation with the Radio Society of Great Britain.

Correspondence with Clubs should be addressed to the Secretaries direct in every case, unless otherwise stated.

Wanstead Wireless Society.*

Hon. Secretary, Mr. A. B. Firman, 18, Clavering Road, Wanstead Park, E.12.

A very successful meeting of the Society was held on November 9th, when a very interesting lecture on "Crystal Sets" was given by Mr. Wilson. The Marconi concert was particularly well received on a loud speaker, distortion being negligible, and tone and clarity perfect.

The President, Mr. Platt, arranged to continue his course of lectures on November 16th.

Borough of Tynemouth Y.M.C.A. Radio and Scientific Society.*

Hon. Secretary, Mr. G. J. S. Littlefield, 37, Borough Road, North Shields.

On October 26th a special meeting was held at which Mr. Illing, of the Sterling Telephone Company of Newcastle, gave a practical demonstration of the "Magnavox" loud speaker and three-valve power amplifier. There was a splendid attendance, including many members of the Whitley Bay and Monk-seaton Wireless Society.

A Chase Radio five-valve unit set, kindly loaned by Messrs. Kennedy and Scott, provided many signals, which were passed on to a senior Magnavox *via* the three-valve power amplifier. Mr. Illing showed and used a special type of transmitter which was pressed against the side of the larynx instead of being held near the mouth. In using it the words were formed in the usual way, but not actually spoken, the reproduction being obtained by the vibrations of the vocal cords affecting the microphone.

A vote of thanks was accorded Mr. Illing and Messrs. Kennedy and Scott.

Oldham Lyceum Wireless Society.*

Hon. Secretary, Mr. Graham Halbert, 16, South Hill Street, Oldham.

The annual meeting and election of officers for the year 1922-23 was held on November 2nd.

The following officers were elected:—President, Mr. H. Stott; Chairman, Mr. I. P. Holden; Vice-Chairman, Mr. H. D. Marsland; Hon. Secretary, Mr. G. Halbert; Hon. Treasurer, Mr. J. Holden.

The winter session, which commenced at the beginning of October, promises to be a great success. The following lectures have been given:—"Elementary Theory of Wireless Transmission and Reception," by Mr. G. Halbert; "Wireless Receiving Apparatus," by Mr. I. P. Holden, Chairman; "Wireless Reception with Reference to Valves," by Mr. J. R. Halliwell, of Manchester.

Bedford Physical and Radio Society*

Hon. Secretary, Mr. C. W. Clarabut, 194, Castle Road, Bedford.

Meetings were held as follows:—

On July 27th 35 members were present. PCGG was received, but the results were inferior to those obtained on his previously lower power.

At meeting on September 6th, 29 members were present. Dr. J. B. Willmer Phillips took the

chair. It was resolved that future meetings be held fortnightly, recurring on Saturday and Wednesday alternately.

An interesting discussion took place on the various circuits, with their attendant advantages and disadvantages. Messrs. Pyrah, Mercier, and the Hon. Secretary took the leading parts.

Mr. R. W. L. Phillips took the chair on September 16th. 28 members were present. Mr. C. W. Clarabut gave a lecture on Radio Symbols, after which several members gave their experiences with their receiving sets.

Malvern Wireless Society.*

Hon. Secretary, Mr. N. H. Gwynn Jones, Burford House, Gt. Malvern.

A good attendance marked the opening of the Society's first meeting on October 25th at the Drill Hall, when a lecture was given by Mr. L. H. Mansell on "The History and Progress of Wireless."

He touched upon the earliest discoveries of Hertz, Marconi's early experiments and the rapid strides which have since been made. Pioneer apparatus, including coherers, crystals, etc., were exhibited.

An excellent demonstration was given with the help of another member, Mr. M. Jeynes, on Mr. Mansell's five-valve set and Magnavox loud speaker.

Mr. R. Green then gave a talk on the easiest way of learning Morse. Great interest was displayed by the lady members present.

Mr. Mansell-Moullin, F.C.S., the Society's Vice-President, was heartily welcomed.

Both lecturers were accorded an enthusiastic reception.

The Society has had an aerial and fittings presented to them by Messrs. L. H. Mansell and M. Jeynes, and hopes to have a set of apparatus at an early date.

Meetings are to be held each Wednesday evening at 8 p.m. at the Society's headquarters at the Drill Hall, Albert Road.

On Nov. 8th, the third lecture was given by Mr. M. Jeynes, on "Aerials and Earths."

The fourth lecture was given on November 15th, by Mr. L. H. Mansell, entitled "D.C. Electricity." It was to be regretted that the attendance was not better, for it was a lecture that few beginners should have missed.

A vote of thanks was accorded Mr. Mansell. Membership is now 60.

Streatham Radio Society.*

Five new members were elected on November 8th. Mr. A. G. Wood was elected Asst. Secretary.

A lecture was given by Mr. A. G. Wood on "Tuned Anode Circuits."

The next lecture meeting will be held on December 13th, when Mr. C. H. Roddis will give a demonstration and lecture on "Transmission and Reception of Infra-Red Rays."

Cheltenham and District Wireless Association*

Hon. Secretary, Mr. Eric Cole, A.R.I.B.A., 28, Milton Road, Cheltenham.

On November 7th the Association held its first public demonstration at the concert hall of the United Services Club, Cheltenham.

The demonstration was attended by a large audience, and was an experimental one arranged by the club members.

Mr. W. G. H. Brown kindly arranged to transmit speech and gramophone selections from his station 5 BK.

The transmission was received on a five-valve set loaned by members and a Magnavox loud speaker lent by Messrs. Dunn & Co.

The Association holds lectures and demonstrations every Monday evening at 7 p.m., and hope shortly to have their own set in operation. A series of interesting and instructive lectures is arranged for the ensuing winter session.

Smethwick Wireless Society.*

Hon. Secretary, Mr. R. H. Parker, F.C.S., Radio House, Wilson Road, Smethwick, Staffs.

On Friday, October 27th, an interesting lecture was given by the technical adviser, Mr. C. Grew, on the "Super-Regenerative Circuit," followed by a demonstration, on apparatus of his own make, which was very excellently made. A hearty vote of thanks was accorded to Mr. Grew, who reciprocated. The Committee are endeavouring to form a syllabus of lectures and demonstrations.

The President, Mr. R. W. Hutchinson, has promised to give three lectures.

On November 24th, Mr. R. H. Parker will lecture on "Alternating Currents Applied to Generating Stations." It is also hoped to give a public demonstration at a convenient date.

Glasgow and District Radio Club.*

Hon. Secretary, Mr. W. Yuill, 93, Holm Street, Glasgow.

At a meeting held in the Club-room, 200, Buchanan Street, Mr. Pick lectured on "Some Set." The set, on view during the evening, had seven valves, three H.F. detector and three L.F., each valve being controlled separately. Mr. Turner and Mr. Carlisle led the questions. Strong signals were received from a number of home and Continental stations.

A hearty vote of thanks to Mr. Pick brought the meeting to a close.

Fulham and Chelsea Amateur Radio and Social Society.*

Hon. Secretary, Mr. R. Wood, 48, Hamble Street, Fulham, S.W.6.

The attendance on November 7th was again very satisfactory, and with the aid of a five-valve set loaned by one of the members a pleasant and instructive evening was attempted, but owing to severe disturbances from a local generator it was found impossible at the time to get at all clear signals.

Mr. Whitts in the meantime read and lectured from one of R. D. Bangay's books; this was heartily appreciated.

Special precautions will be taken with the Society's receiving set to insure it against all disturbances. This set is now in the course of construction by the members themselves.

Clapham Park Wireless Society.*

Hon. Secretary, Mr. J. C. Elvy, 3, Fontenoy Road, Bedford Hill, S.W.12.

The tenth general meeting held at headquarters, 67, Balham High Road, on November 1st, was well attended. Mr. A. E. Radburn was again elected Chairman for the evening.

Hon. Secretary reported having received necessary information from Hon. Secretary of the Wireless Society of London preparatory to affiliation, and has replied in accordance, anticipating an early fusion.

A letter was received from Mr. J. Ayres—2 QD portable transmitting station—drawing attention to misleading report in Wireless Press relative to the writer's demonstration at the sixth meeting of the Society on October 4th last. The Hon. Secretary is most anxious to correct this report by stating that the whole apparatus was provided by Mr. J. Ayres for both transmitting and "listening-in." Mr. J. A. Daniels said that at the last moment the "Magnavox" apparatus he had promised to bring along was not available. Mr. J. A. Daniels' explanation thus cleared the matter up, the Hon. Secretary undertaking that the correction should appear in press columns, expressed his regrets.

Further new members were elected. The Chairman then called upon Mr. C. D. Richardson to continue his lecture of October 18th, 1922, which he did with the aid of apparatus he had brought for demonstrational purposes, including an old Mark III set.

His remarks were suitably illustrated.

The opportunity was seized by several present to "listen in" on the apparatus Mr. C. D. Richardson had brought with him, when coupled up to Society's aerial.

The Hon. Secretary points out that membership is rapidly approaching the figure beyond which new entrants will be called upon to pay an additional 2s. 6d. entrance fee to the yearly subscription of 7s. 6d.

Fulham and Putney Radio Society.*

Hon. Secretary, Mr. J. Wright Dewhurst, 52, North End Road, West Kensington, London, W.14.

At Headquarters, Fulham House, Putney Bridge, on November 10th, a letter was read in reference to the Amateur Transmissions to America, and it was proposed to let the technical committee deal with this as they have the arrangement of the Society's apparatus.

A letter was read from Captain Ian Fraser, of St. Dunstons, thanking the Society for the assistance to the blinded soldiers and sailors.

During a discussion Mr. Wooding fitted up his six-valve unit panel set. A series of experimental tests were made with English, Dutch and American valves.

Ilkley and District Wireless Society.*

Hon. Secretary, Mr. E. Stanley Dobson, "Lorne House," Richmond Place, Ilkley.

On November 6th Mr. E. Dobson took the chair. The President, Dr. J. B. Whitfield, lectured on "The Relation Supposed to Exist Between Electricity and Matter." He gave an interesting demonstration of the action of electronic emissions, by means of a very fine X-ray outfit, specially brought for the occasion.

Ealing and District Radio Society.*

Hon. Secretary, Mr. W. F. Clark, 52, Uxbridge Road, Ealing, W. 5.

Several important changes have taken place with regard to the future of the Society and a special meeting was convened for Tuesday, October 10th, 1922 to consider the following arrangements: (1) It has been decided that the old headquarters at Westfield House were not quite suitable as a permanent meeting place from several points of view, and having had a most generous offer from the Directors of the London Radio College, 82, High Street, Brentford (opposite Half-acre) to the effect that they are prepared to let the Society have the use of the lecture hall, telegraph room for buzzer practice, use of existing aerial, and all other conveniences (storage for bicycles, etc.) for a most moderate rental in order to encourage the Society, the meeting unanimously decided to accept their kindly offer. (2) Meetings will in future be held on Friday evenings from 7.30 to 10 p.m. in order to meet the wishes of the majority of members; the acquisition of the new premises has already given a considerable fillip to the membership numbers. (3) In view of the fact that the new headquarters are in a fresh locality, it has been felt that the old name was hardly applicable on account of the attendance of members from surrounding boroughs: it was therefore decided to adopt the name of the "Ealing and District Radio Society."

On Friday, October 20th, the syllabus of lectures commenced with a lecture by Mr. Watton entitled "Accumulators, the care and construction of," and following weekly: "H.T. Batteries," "Condensers, their functions and characteristics," "Symbols and Diagrams as used in Wireless," "A single valve receiving set, construction and cost," "Crystals and Crystal Detectors," "Coils: Slab, Basket, Duolateral, etc., their construction and efficiency."

These lectures will prove to be very useful, especially to those who are novices in the new science, and it is hoped that all members will encourage (by their attendance as often as possible) those gentlemen who are endeavouring to make the Society a real success.

Beginners disposed to join, yet who feel their lack of knowledge, will be made welcome and their needs specially catered for. Prospective members have the option of attending one meeting without obligation to join. Application forms may be obtained from the Secretary, or at any ordinary meeting of the Society at the College.

Belvedere and District Radio and Scientific Society.*

Hon. Secretary, Mr. S. G. Meadows, 1, Kentish Road, Belvedere, Kent.

At the Erith Technical Institute, on November 10th, the eleventh general meeting was held.

Mr. H. H. Smith gave his paper on "The Properties of Crystals." Some very fine specimens were exhibited. During the lecture some bismuth was melted in a crucible and allowed to cool; afterwards the crucible was broken in two, showing the bismuth re-crystallised.

Mr. Smith received a vote of thanks. It is hoped to continue tests on double crystals at the next meeting.

The Manchester Radio Scientific Society.*

Hon. Secretary, Mr. H. D. Whitehouse, 16, Todd Street, Manchester.

At headquarters on November 1st, Mr. Boullen in the chair, it was resolved that meetings be held weekly for the present, every alternate night being devoted to assisting beginners. Several new members were elected and suggestions were invited for lectures.

Mr. J. R. Halliwell gave a short talk on "Broadcasting, with Special Reference to the Amateur's Position." He received a very hearty vote of thanks.

On November 16th Mr. G. G. Boullen was again in the chair. One new member was elected. Mr. J. W. Hand opened a discussion on "The Construction of Wireless Sets," with special reference to the three-valve set in operation at the meeting.

A demonstration of telephony reception from 2 ZY (Metro-Vick, Manchester) followed. Mr. J. Kemp, who had very kindly brought the gear to the meeting, proceeded to deal with constructional details, such as working ebonite, winding coils, etc. A vote of thanks was passed to Messrs. Hand and Kemp.

Hackney and District Radio Society.*

Hon. Secretary, Mr. E. R. Walker, 48, Dagmar Road, Hackney, E.9.

A special general meeting was held at headquarters, the Y.M.C.A., Mare Street, on November 9th, Mr. Harry A. Epton, the Chairman, presiding. There was an attendance of over 50, including six new members.

A letter from the Wireless Society of London with regard to the position of amateurs under the new broadcasting regulations was read, and the Wireless Society's reply was considered satisfactory.

It was decided to institute two classes of members, viz., senior members (18 years of age and over) and junior members (under 18), the senior members to pay an entrance fee of 5s. and an annual subscription of 10s., and the juniors to pay 2s. 6d. and 5s. respectively, in place of the present flat rate of 3s. 6d. per member per quarter, irrespective of age; this new rule to commence from January 1st, 1923.

It was also decided to hold the annual meeting in January instead of in July, and that nominations for the officers and committee should be closed a week before the annual meeting.

It was felt that efforts should be made to obtain lecturers from outside sources, and the Chairman was requested to communicate with the national society and other bodies with a view to this end.

At another meeting at the headquarters, Y.M.C.A., Mare Street, Hackney, on November 16th, the Chairman, Mr. H. A. Epton, presided. A hearty vote of congratulation was passed to Sir Arthur Lever, Patron of the Society, on his election as M.P. for Central Hackney.

Two home-made sets of three valves each, loaned by members, were used with a Brown's loud speaker. The London broadcast programme was received.

A spirited discussion took place on valves *v.* crystals between Mr. Valins and Mr. Bell.

The Radio Club, Argentino.

Secretary, Señor Eduardo F. Jacky, Buenos Aires. At the celebration of the Club's first anniversary the following officials were elected:—Honorary President, Capt. Luis F. Orlandini (Navy); President, Señor Ezequiel P. Paz; Vice-President, Señor Teodoro Bellocq; Secretary, Señor Eduardo F. Jacky; Assistant Secretary, Señor Roberto del Rio; Treasurer, Señor Horacio G. Larreta. Members of Committee: Señors José Canals, Adrian B. Jones, Dr. Guillermo Rojo, Ovidio F. Carpinacci, F. Sauce and Jorge M. Delfino.

There are now nearly 400 members, and very shortly new and larger premises are to be taken.

Lambeth Field Club and Morley College Scientific Society.

(Physics and Wireless Section).

Hon. Secretary, Mr. F. W. Ling, Physics Laboratory, Morley College, Waterloo Bridge Road, S.E.1.

Mr. R. F. Cossar lectured on November 11th on "The Making of a Two-Valve Set." He dealt with the tools necessary for making the set, material, valves, etc.

Southampton and District Wireless Society.

Hon. Secretary, Mr. T. H. Cutler, 24, Floating Bridge Road, Southampton.

A record attendance of members was recorded on November 9th at the Kingsland Assembly Room, both Presidents of the Society, namely Major-Gen. Sir Ivor Phillips and the Rt. Hon. Dudley Ward, being present. Both gave a short speech. Mr. Goodall transmitted a concert which was splendidly received. Later Mr. Goodall called up both the Presidents to wish them every success at the forthcoming election. The result of the Single Valve Competition was Mr. Spear first prize and Mr. Wainborough second prize. The prizes were given and presented by Dr. MacDougall.

South Shields and District Radio Club.

Hon. Secretary, Mr. J. A. Smith, 66, Salmon Street, South Shields.

The eighth meeting was held on November 7th in the Liberal Club Buildings, Ocean Road, South Shields (temporary headquarters).

The Chairman reported that the Club's application for a transmission licence had been acknowledged.

A new aerial has been erected and tried. Telephony was heard from broadcasting stations at London and Manchester, and the experimental station of the Chase Radio Company, Newcastle.

A two-valve resistance coupled set, of home construction, was next demonstrated by a member.

The next meeting was held on November 24th, when a lecture on "Valve and Crystal Detectors" was given by Mr. Moore, Instructor in Wireless Telegraphy, South Shields Marine School.

Hornsey and District Wireless Society.

Hon. Secretary, Mr. H. Davy, 134, Inderwick Road, Hornsey, N.8.

The chair was taken by Mr. H. J. Pugh on November 3rd, 1922; a successful raffle took place in aid of general funds for Society apparatus. The winner, ticket holder 142, received a crystal set complete, valued £5 10s. The Treasurer received a substantial sum on behalf of the Society.

An interesting lecture was given by Mr. H. J. Pugh, who demonstrated a crystal detector and two-valve amplifier. Several new members were elected.

The Wireless Society of Winchester.

Hon. Secretary, Mr. Albert Parsons, 65, Cromwell Road, Winchester.

"Lower House Sale Rooms" have been opened for the Society by very kind permission of Mr. Wm. Tanner, to whom the rooms belong. Meetings are held on Tuesday evenings, although the club-rooms will be open every night to members. The present membership is very satisfactory.

The Secretary would be very pleased to hear of any amateur who hears the call 2 MM (Mr. Cecil C. A. Hines, Twyford) giving particulars, etc., of position, time and conditions.

The following officers have been elected temporarily:—Chairman, Mr. S. R. Humby; Vice-Chairman, Mr. W. E. Smith; Treasurer, Mr. P. A. Gibbs. It was decided that the Committee should consist of all members, and should a certain problem remain unsolved, a special Committee consisting of five full members be elected for the purpose.

Fees have been fixed, viz., full members, 10s. 6d.; associate members, 7s. 6d.; country members, 5s. 6d.; with no entrance fee.

Cambridge University Wireless Society.

Hon. Secretary, Mr. J. B. Hickman, 4, Rose Crescent, Cambridge.

The first meeting of the Michaelmas term was held on October 12th, 1922, in the Engineering Laboratory. The following officers were elected for the ensuing year:—President, Mr. F. S. Thompson, Peter House; Hon. Secretary, Mr. J. B. Hickman, Gonville and Caius College; Treasurer, Mr. F. P. Best, Gonville and Caius College.

On October 27th, the Hon. Secretary read a paper to the Society entitled "Wireless as a Prime Communication in the Field." The paper dealt with a scheme of wireless communication that was used during the operations in Ireland in 1921. The chief interest of the paper was that it described a scheme in which wireless, for the first time perhaps in military history, occupied the first place.

On November 1st, Mr. E. V. Appleton, M.A., St. John's College, delivered a most interesting lecture on the measurement of signal strength. The substance of the paper was a description of some original work carried out by the author on a method of measurement of signals which was suggested by some observations of Dr. Vincent on the behaviour of two oscillating coupled circuits. It was found, if there were two oscillating circuits, one oscillating strongly, the other weakly, that in the neighbourhood of synchronous oscillation, the stronger oscillation forced the weaker oscillation. The lecturer drew attention to the fact in the phenomenon of the silent space, that the beat frequency did not decrease in a linear fashion. This was due to the forcing. The lecturer then went on to describe the method he used. The strength of signal was measured by the silent space—the bigger the silent space the stronger the signal. The actual strength could be calculated from a formula embodying the length of the silent space, the capacity of the aerial and the impressed E.M.F. from the heterodyne. The E.M.F. was measured with a Moullin voltmeter, and the experiments carried out with an autodyne single valve receiver. Very satisfactory results have been obtained in observing the signals from Ongar at Cambridge. An interesting discussion followed, and a very hearty vote of thanks was passed to the lecturer.

Manchester Wireless Society.*

The annual general meeting was held in the Council Chamber, Houldsworth Hall, Deansgate, on November 10th. Mr. McKernan was in the chair. Reports of the Secretary and Treasurer were presented. The total number of members to date was 189 as compared with 107 for the end of the previous year.

After introducing the new Chairman, Mr. Barraclough, Mr. McKernan was given a rousing applause from the members in recognition of his splendid service.

Mr. Barraclough read the following appointments for the ensuing year:—First Past President, Mr. J. Hollingworth, M.A. President, Dr. Stanley Hodgson, M.D. Vice Presidents: Messrs. E. Blake, J. H. Brown, W. W. Burnham, G. E. Duveen, M.A., H. Green, S. R. Mullard, M.B.E., F. Phillips, J. C. A. Reid, J. C. Wrigley. Vice-Chairman, Mr. W. R. Anderson. Mr. Evans was again unanimously elected Hon. Secretary, and Mr. W. H. Lamb Hon. Treasurer.

The ballot papers which had been distributed by post were then collected and scrutineers appointed to count the votes. An interval was allowed for discussion, after which the result of the voting was announced as follows. These members will form the Committee for the next year of office: Messrs. E. G. Davies, A. G. Gregory, R. Hallam, H. L. Holt, F. Taylor, B. L. Stephenson. Mr. R. Dawson and Mr. J. J. Burne were appointed Auditors. It was resolved to ask the Committee to collect information as to the suitability of forming branches of the Society. An entirely separate branch to provide elementary lectures is being formed for broadcast licensees. The Committee were empowered to draw up the necessary rules.

Lady members' subscriptions were fixed at 10s. 6d. per annum inclusive of entrance fee. Amendments to rules were discussed. With regard to the Transatlantic Station Mr. Evans announced that a special test on 1 k.W. spark had already been carried out on Sunday, November 5th, and a further attempt on C.W. on November 12th, 19th and 26th, the first on 500 watts and the last two on 1 k.W. The reception of these unofficial tests was carried out by the A.R.R.L., and the special station for reporting results was 2 FP. On November 13th the Society gave a lecture and demonstration in aid of the Manchester and Salford Hospital Saturday Fund. The lecturer was Mr. Evans and the demonstration arrangements were very successfully carried out by Mr. W. C. Barraclough and his two sons.

Southwark Wireless Telephony Association.

Hon. Secretary, Mr. W. Helps, King's Hall, London Road, S.E.1.

The first meeting of the month was held at headquarters, on October 1st, when Messrs. A. O. Gibbons and Winstone gave a very instructive lecture, illustrated by slides, on "Elementary Wireless." Interesting discussion followed. A vote of thanks to the lecturers concluded the meeting.

The second meeting of the month was held on October 15th, when Mr. Dibben gave a lecture on the functions of a condenser, also aeriels and their faults, followed by discussion. After the vote of thanks to the lecturer, the Secretary reminded members that it was desired that they

would all do their best to make the wireless concert, arranged to help the funds of King's College Hospital, a financial success; special transmissions had been arranged, and Mr. W. F. Hurdall was giving the hall entirely free. Tickets cost a shilling, and the concert commences at 7.15 p.m. on November 5th.

Eastern Enfield Wireless and Experimental Society.

Hon. Secretary, Mr. Arthur I. Dabbs, 315, High Road, Ponders End, N.

Two new members were elected at Headquarters, The Falcon Inn, South Street, Ponders End, on November 9th.

After discussion on general business, the Society's set was brought into operation, and one or two amateur transmissions came in well on the loud speaker. At 9 o'clock some excellent musical items from Marconi House were enjoyed. After the concert the rest of the evening was spent in general discussion, and endeavours to straighten out the licence question.

A small library and certain articles of apparatus are now available for loan to any of the members.

Reading Radio Research Society.

Hon. Secretary, Mr. J. J. Baker, Broadway Buildings, Reading.

The first meeting of the winter session was held at the University College, Reading, on November 7th, when, after electing the officers for the current year, a very interesting lecture was given by Mr. W. Atkins on "The Working of Telephones."

A licence for a receiving set has been applied for and it is hoped to shortly erect an aerial at the University College for demonstration at future meetings, which will, of course, also be useful for scientific purposes in connection with the University itself.

It is hoped to organise in the near future a conversation and a sale of parts among the members, but further particulars will be announced later.

Watford and District Radio Society.

Hon. Secretary, Mr. F. A. Moore, 175, Leanesden Road, Watford.

The formation of the above Society is now complete, and a programme of lectures, demonstrations, etc., is in course of preparation.

A meeting was held at headquarters, The National Schools, Watford, on November 6th, the principle item being a lecture by Mr. C. S. Hall on "Honeycomb Coils," and the construction of the machine for winding them.

A miniature crystal set made by Mr. Bevan was used in conjunction with two basket coils, and gave excellent results.

The club-room is open each Monday and Friday evening from 7 till 10.

Plymouth Wireless and Scientific Society.

Hon. Secretary, Mr. G. H. Lock, 9, Ryder Road, Stoke, Devonport.

Mr. E. W. Penney lectured on "Valves and Valve Receiving Circuits" on November 14th. He dealt with the electron theory, more particularly in its application to valve working. Later he gave a clear exposition of grid rectification, the action of the grid condenser and leak being explained in a simple and satisfactory manner. The lecture was concluded on November 29th.

Notes

The Birmingham Broadcasting Station.

"Listeners-in" had a pleasant surprise on Wednesday, November 15th, when they received the Birmingham Broadcasting Station for the first time. The station had been previously installed in the London offices of The Western Electric Co., Norfolk Street, W.C.2. Instructions were received on Friday, November 10th, to transfer the station temporarily to the works of The General Electric Co., at Witton, Birmingham. The set was therefore dismantled and conveyed to Witton by Lorry, arriving there on the afternoon of Sunday, November 12th, and installation was commenced immediately under the direction of Western Electric Engineers, and with labour supplied by the courtesy of The General Electric Co. In a short time a small army of painters, carpenters, wiremen, etc., were busy installing the apparatus and the antenna, and decorating the rooms. By 4 o'clock on Wednesday afternoon, November 15th, the station was ready, and after an hour's preliminary testing, commenced serious operations. A concert was transmitted from 5 p.m. until 11, and afterwards election results were broadcast until 1 a.m. From the first, the transmission was excellent—a fact which is attested from all parts of the country.

The Western Electric Broadcasting Set is designed to deliver about 500 watts of radio frequency power to the antenna. It has a rated range of 100 miles, which means that satisfactory operation may be expected at this distance when using an average valve set comprising, say, a single detecting tube with reaction, and the usual aerial. It should, of course, be borne in mind that it is impossible to state the range with accuracy, since this is affected by so many factors—the transmitting antenna, the type of efficiency of receiving equipment used, the absorption between the two stations, etc. When conditions are favourable—at night time, for instance—the broadcasting station will be heard in suitable sets at very much greater distances.

Automatic Wireless Transmission at Sea.

The Marconi International Marine Company, Ltd., installed on board the White Star liner *Majestic* high speed automatic transmitting apparatus. Hitherto only hand transmission has been used by wireless operators at sea, but the amount of traffic has recently grown so enormously on the *Majestic* that it has been found necessary to introduce automatic working. The *Majestic* is the first liner to be fitted in this way. The maximum speed of the automatic apparatus used is 240 words per minute.

O.T.C. Wireless Instruction.

Army Council Instructions provide for a course in wireless telegraphy for officers and cadet non-commissioned officers of the Senior and Junior Divisions during the Christmas vacation at the Signal Training Centre, Maresfield, from January 2nd to 13th. Applications must reach the Secretary (S.D.3.B.), the War Office, Whitehall, London, not later than December 4th.

Bickendorf Aerodrome W/T Station.

An Air Ministry Notice to Airmen states that a temporary W/T Station has been opened at

Bickendorf Aerodrome, Cologne. Particulars of the service rendered by this station are:—(a) Call Signal: GEK. (b) Hours of service: 0900-1600 G.M.T. (c) Wavelengths and routines: (i) 900 metres. R/T communication with aircraft. A short range station is employed on this wave and is manned only when aircraft are expected. (ii) 1,400 metres. Route Traffic with Air Ministry (GFA) and with Brussels (OPVH). Receiving Watch on this wavelength is interrupted when transmission is taking place as laid down in paragraphs c (i) and c (iii) of this Notice. (iii) 1,680 metres. Meteorological broadcasting. The station broadcasts a meteorological report at the following times: 0915, 1015, 1115, 1215, 1315, 1415, 1515 G.M.T. Notice to Airmen 43 of 1922 is amplified accordingly.



Duet by Mr. John Huntington and Miss Olive Sturgess. Mr. R. Stauton Jefferies, A.R.C.M., at the piano. The much discussed chimes are in the background.

A Souvenir.

Described as "A Souvenir of a Historic Event," a concise and highly interesting booklet has been prepared by Marconi's Wireless Telegraph Co., Ltd., which contains the message transmitted by H.R.H. the Prince of Wales to the Boy Scouts on October 7th. A description of the transmitting arrangements and reports of the receptions giving the town, distance, name, kind of receiver and comments are given. Each person who sent a report to Marconi House is to receive a copy, and a special copy bound in vellum has been sent to His Royal Highness, who has expressed great interest in the reports.

Proposed Society at Horwich (Bolton).

Particulars of the proposed Wireless Society for Horwich (near Bolton) may be obtained from Mr. P. Ashurst, 51, Mary Street East, of that town.

Slight Change in Wavelength of 2 LO.

It is announced that the wavelength of 2 LO has been changed to 369 metres, in order to avoid interference which was previously experienced. This change although so slight appears to have accomplished its purpose.

CORRESPONDENCE.

To the Editor of THE WIRELESS WORLD
AND RADIO REVIEW.

SIR,—It may interest 2 JZ to know that I received his C.W., on about 200 metres, strongly on Saturday and Sunday evening, using 1 valve, and telephony on Sunday evening on the same wavelengths. I could just read the latter, there being little jamming at the time. My aerial is 100 ft. long, and average height is about 27 ft.

Nearly all my set is home constructed, including tuning coils (duolateral).

Belford.

November 6th.

J. HEATON ARMSTRONG.

PERSONAL.

The Council of the Institution of Electrical Engineers of London at the last meeting announced that Dr. J. A. Fleming, F.R.S., had been unanimously elected an Honorary Member of the Institution. Dr. Fleming has accepted the invitation to give the Fourteenth Kelvin Lecture to the Institution next May. The Royal Society of Arts recently awarded him one of their Silver Medals for the Fifth Henry Trueman Wood Lecture he gave to them on November 23rd, 1921, on "The Coming of Age of Long Distance Wireless Telegraphy and Some of Its Scientific Problems."

Radio Society of Great Britain.

AT the meeting of the Radio Society of Great Britain (late Wireless Society of London) held on Wednesday, November 22nd, the following were elected to membership of the Society:—

C. Creswick Atkinson, E. Dawson Ostermeyer, Clifford Rattray, George Smith Lindenholve, George F. Taylor, John Barnard, Matthew Marshall, James W. Allen, Edward C. Leach, Archibald J. Maitland, John A. Partridge, Fred A. Bourne, Anthony E. Chester, Walter O. Bentley, George G. Welsh, John Bates, Percy R. Fairclough, Cyril G. Webster, Maurice H. Saffer, Y. W. P. Evans, Richard H. Wagner, H. T. P. Gee, Frederick W. Walter, Kenyon Secretan, Clifford W. Andrews, Conrad J. Beck, S. E. Mackeown, Fred H. Robinson, Major Reginald Beckett, A.M.I.C.E., Capt. H. C. J. A. R. West, R.N., Thomas Watson, William A. Ward, L. Howard Flanders, Reginald G. Waller, John S. Pallister, Albert E. Bowyer Lowe, John Hall Rider, M.I.E.E., Arthur E. Morris, Ettore Bellini, D.Sc., E. W. Kent, A. C. Cockburn, M.I.E.E., Leonard M. Robinson (Lieut., R.N.), George G. Jack, Percy C. Kidner.

The following were elected Associate Members:—

Francis W. Laing, Isabel C. Fogarty, John W. Boys.

The following Wireless Clubs and Societies were accepted for affiliation:—

Thames Valley Radio and Physical Association, Morley College Scientific Society (Wireless Section) Grimsby and District Radio Society, The Leys School Wireless Society (Cambridge), Darwen Wireless Society, Clapham Park Wireless Society, Huddersfield Radio Society, Loughborough College Wireless Society, Barnsley and District Wireless Association, Rhyl and District Amateur Wireless Society, Ealing and District Radio Society, Tottenham Wireless Society, Bromley Radio and Experimental Society (Kent), Boots' Radio Society (Nottingham), Hereford and District Radio and Scientific Society, Powysland Radio and Scientific Society (Welshpool), Birkbeck College Wireless Society, Newbury and District Wireless Club, Harrogate and District Radio Society, Malvern Wireless Society.

THE EFFECT OF UNDERGROUND METAL WORK ON RADIO DIRECTION FINDERS.

FURTHER to the discussion on the above subject which was brought before the meeting of the Wireless Society of London on October 25th, 1922, by Mr. R. L. Smith-Rose, M.Sc., Mr. J. F. Stanley, B.Sc., says:—

"I notice in *The Wireless World and Radio Review* of November 11th that reference was made at a meeting of the Wireless Society of London to the experiments of Mr. Umberto Bianchi, an Italian inventor, who claims to have devised a system to detect underground mineral deposits. I had the pleasure of meeting Mr. Bianchi some months ago, and I was present at a demonstration given by him to a gathering of mining engineers at the Royal School of Mines. I subsequently had the opportunity of carrying out some experimental work in this direction myself, with very encouraging results. In one of these tests, carried out in the goods yard of the City and Guilds Engineering College, I was able to trace out the course of an iron drainpipe, the existence of which I was totally ignorant of at the time.

"I may say that the method employed does not depend on the errors in the observed readings of a direction finder, as in the experiments of Messrs. Smith-Rose and Barfield, but on the deflection of an electro-magnetic field due to the presence of a deposit of conductive mineral. By this method it is claimed that the depth and shape of any mineral deposit can be very accurately estimated, and from my own observations and experiments I think the method will be widely used in the future."

A New Club.

From Mr. D. H. Brayne, of 29, Rutland Park, Willesden Green, N.W.2, we learn that a movement has been made to form a Wireless Society in Cricklewood and Brondesbury, under the auspices of the Willesden Polytechnic Electrical Engineering Society.

The Society is open to both sexes, and an inaugural meeting was held on November 25th. Enquiries may be sent to Mr. Brayne.

Calendar of Current Events

Friday, December 1st.

BRADFORD WIRELESS SOCIETY.
At 5, Randallwell Street. Lecture by Mr. Liardet.

MANCHESTER WIRELESS SOCIETY.
At 7.30 p.m. At Houldsworth Hall. Lecture on "Radio Measurements and Measuring Instruments," by Mr. Bertram Hoyle, M.Sc.

NEWCASTLE AND DISTRICT AMATEUR WIRELESS ASSOCIATION.

At 7.15 p.m. At Engineering Theatre, Armstrong College. Lecture on "Some Observations on Distortion in Wireless Telephony," by Mr. W. Owen.

BELVEDERE AND DISTRICT RADIO AND SCIENTIFIC SOCIETY.

Lecture on "Common Faults in Receiving Circuits," by Mr. A. H. Norman.

LEEDS AND DISTRICT AMATEUR WIRELESS SOCIETY.

At 7 p.m. Exhibition of apparatus and demonstration of telephony at the Blenheim Institute. Also the following day at 3 p.m.

Saturday, December 2nd.

CROYDON WIRELESS AND PHYSICAL SOCIETY.
At 7.30 p.m. Annual General Meeting and lecture on "Small Rectifiers for Charging from A.C."

Sunday, December 3rd.

3-5 p.m. *Daily Mail* Concert from PCGG, The Hague, on 1,050 metres.

Monday, December 4th.

9.20-10.20 p.m. Dutch Concert, PCGG, The Hague, on 1,050 metres.

IPSWICH AND DISTRICT WIRELESS SOCIETY.
At 8 p.m. At 55, Fonnereau Road. Lecture on "Magnetism," by Mr. W. E. Kersey.

Tuesday, December 5th.

WEST LONDON WIRELESS AND EXPERIMENTAL ASSOCIATION.

At 7 p.m. At Acton and Chiswick Polytechnic, Bath Road, Chiswick, W.4. Annual General Meeting.

LOWESTOFT AND DISTRICT WIRELESS SOCIETY.
Special competition. Details at the meeting.

Wednesday, December 6th.

INSTITUTE OF ELECTRICAL ENGINEERS.
(WIRELESS SECTION.)

At 6 p.m. At Victoria Embankment. Meeting.

REDBHILL AND DISTRICT Y.M.C.A. WIRELESS SOCIETY.

At 111, Station Road, Redhill. Lecture on "Gadgets," by Mr. Clarke.

PORTSMOUTH AND DISTRICT AMATEUR WIRELESS SOCIETY.

Social evening and demonstration. Special transmission from Eiffel Tower.

MALVERN WIRELESS SOCIETY.

Lecture on "A.C. and Oscillatory Currents," by Mr. L. H. Mansell.

EDINBURGH AND DISTRICT RADIO SOCIETY.

At 8 p.m. At Headquarters. Business meeting and lecture on "A Syphon Recorder for W/T," by Mr. W. Winkler.

Thursday, December 7th.

At 9.20-10.20 p.m. Dutch Concert from The Hague on 1,050 metres.

LUTON WIRELESS SOCIETY.

At 8 p.m. At Hitchin Road Boys' School. Practical Work and Experiments.

DERBY WIRELESS CLUB.

At 7.30 p.m. At "The Court," Alvaston. Lecture on "Rubber," by Mr. E. H. Tawn.

HACKNEY AND DISTRICT RADIO SOCIETY.

Lecture on "Insulating Materials," by Mr. Sanford.

NEWPORT AND DISTRICT RADIO CLUB.

Public Wireless Concert.

Friday, December 8th.

LEEDS AND DISTRICT AMATEUR WIRELESS SOCIETY.

At 7 p.m. Lecture and Demonstration on "Recording Apparatus," by Mr. A. M. Bage.

Meeting of Transmitting Licence Holders.

A further meeting of transmitting licence holders in the London area has been called for Thursday, November 30th, at 6 p.m., at the Waldorf Hotel, Aldwych, W.C. The committee appointed at the last meeting will present their report.

The British Radio Manufacturers' and Traders' Association.

On November 20th a meeting, called by the Radio Association, was held at the Hotel Cecil. It appears that the purpose of the meeting was to appoint a committee for a Trade Section of the Association.

After Prof. A. M. Low and Colonel L'Estrange Malone had explained this object members of a second body present—the Wireless Manufacturers' and Traders' Association—protested that they had a committee which had been waiting for six weeks to meet the Radio Association.

After a lively discussion the Secretary of the Traders Association virtually took the meeting out of the hands of the Radio Association, and an entirely new association was formed in less than ten minutes. Members of both the other organisations were recommended to join it at once.

The name of the new association is The British Radio Manufacturer's and Traders' Association, and the address of the Organisation is Dundee House, 15, Eastcheap, E.C.3.

The Wireless Society of London

A MECHANICAL MODEL ILLUSTRATING THE ACTION OF THE THREE-ELECTRODE VALVE.*

By G. G. BLAKE, M.I.E.E., A.Inst.P.

IN a paper which I read before this Society on March 22nd, 1922, I mentioned a mechanical model, which I had constructed to illustrate the action of the three-electrode valve.

Fig. 1 shows the model as it then was. The plate current of the valve is represented by a metal spring, in the centre of which is a small disc of metal, which represents the grid voltage of the valve. Through the centre of the spring and disc, a piece of thread passes, this is stretched on a frame. The frame is supported by springs from above and below. When it is made to oscillate up and down, its movements may be said to represent the incoming oscillations from a distant transmitting station.

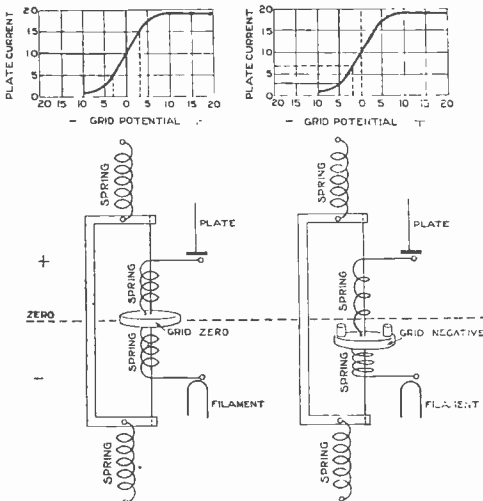

Fig. 1.

The thread, as it rubs up and down against the hole in the disc through which it passes, will cause the grid disc to oscillate above and below the zero line, shown in Fig. 1, representing either increase or decrease of grid voltage and plate current.

The left-hand diagram shows the grid functioning at the centre of the characteristic curve of the valve (see curve on left-hand top corner of the figure). In this case the grid disc will oscillate to an equal distance below and above zero line.

If we make the grid of the valve more negative, the right-hand side of Fig. 1 represents the condition of affairs. In this case small weights have been placed on the grid disc to bring it below the zero line, and to represent a negative charge, when the incoming oscillations (represented by the oscillatory movements of the thread) act on the grid. The negative pulse has little or no effect, as the plate spring is already compressed; but the positive half of the oscillation takes effect on the grid and

increases the plate current. We are now working at the lower bend of the curve represented at the right-hand upper corner of the slide.

The compressed condition of the plate spring below the grid gives us a method of visualising the increased density of electrons in the space charge of the valve.

I have recently made several improvements in the construction and applications of this model, which I thought might be of interest to this Society.

Fig. 2 is a photograph of the model in its latest form, which you see before you on the lecture table.

Fig. 3 is a lettered diagram of the model, a brief description of which will, I think, help to make its use more easily understood. The incoming oscillations are represented by the movement up and down of two arrows, painted red and white, to represent the positive and negative half of each oscillation.

In place of the cotton thread in the old model, a metal rod R passes up through the centre of the spring and disc G. To this rod the before-mentioned arrows are attached. At the bottom of the rod is a small wheel W which rests on the rim of a second and larger wheel X acting as an eccentric. When rotated by means of a handle H the rod moves up and down through the grid disc G. There is a screw adjustment on this disc (not shown on the figure) to enable us to arrange for the rod to rub more or less lightly against the disc, as it oscillates (representing weak or tight coupling).

The filament and plate are represented by two metal tubes A and B, which hold the plate current spring V. These two tubes can be raised or lowered to represent alterations in the filament voltage and plate voltage. Both are fitted with pointers and scales, indicating the actual voltages which have been worked out from the curves taken from a valve. By means of this model we can repeat all our experiments and show the various readings obtained in the plate current when filament voltage or plate voltage are altered. The plate scale is shown at the top left-hand side of the model, and reads from 33 to 54 volts, and filament scale is at the bottom left-hand side of the model, and reads from 3.5 to 4 volts.

The scale on the right-hand side represents the grid potential and the pointer can be set, either at the same potential as the filament, *i.e.*, at zero, or up to 6 volts positive, if it is raised, or down to 6 volts negative if it is lowered.

The amount of plate current at any moment is indicated by the pointer on the grid disc G on plate current scale S, which reads from zero to 2 mA.

It will be noticed that the plate current scale is attached to the plate tube B, and moves up and down with it.

The following experiments can be mechanically illustrated. (Fig. 4.)

* A paper read before the Radio Society of Great Britain (late Wireless Society of London) on Wednesday, Nov. 22nd, 1923.

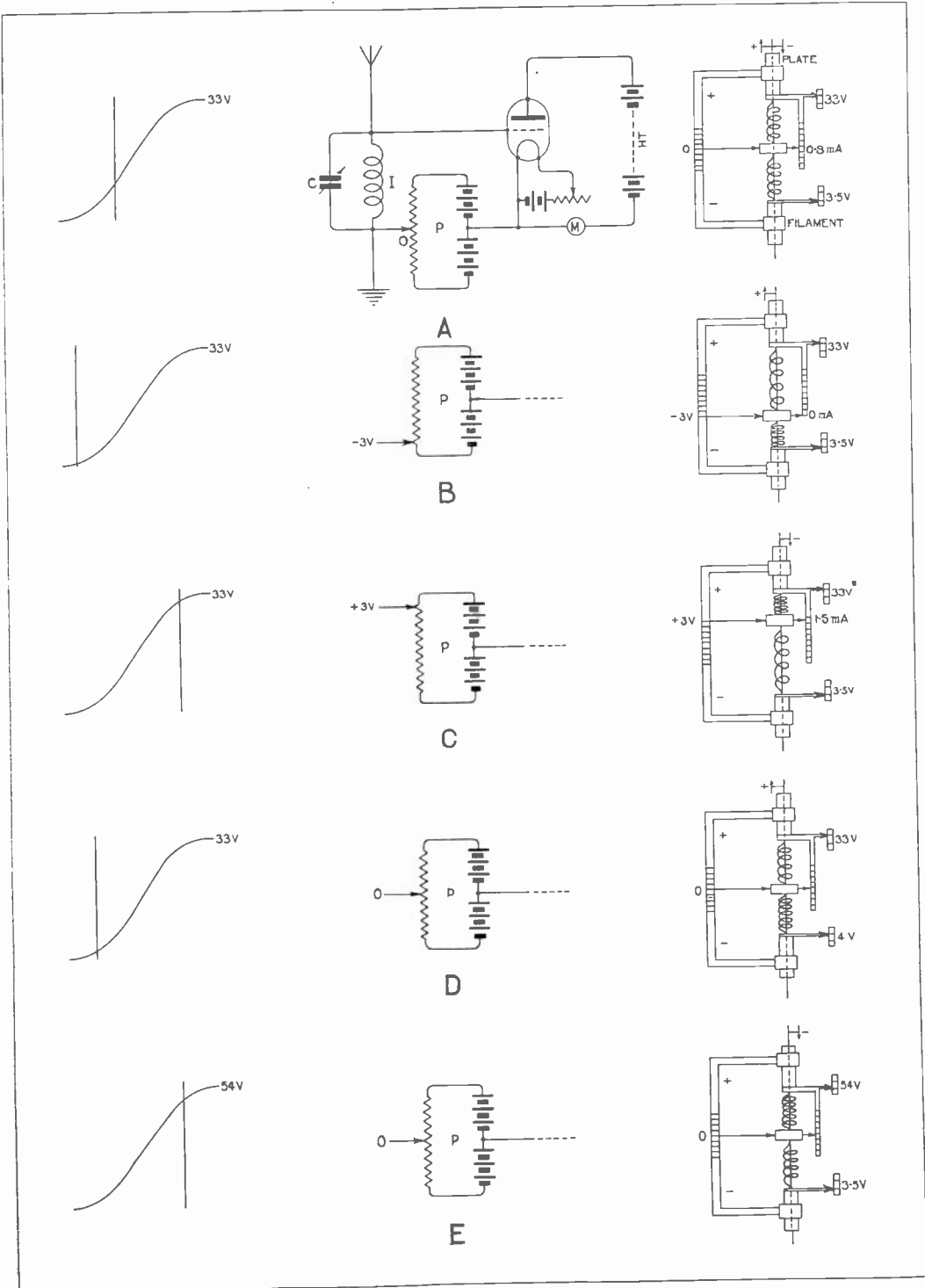

Fig. 4.

we now have a sufficient positive potential on the plate to cope with all the electrons from the filament, and have reached saturation point.

I explained Fig. 5 in my last paper, showing the amount of amplification obtained by increase of grid voltage as against increase of plate current. We can also show the amplification factor of the valve by means of our model.

As the model now stands with grid at zero, and plate at 54 volts, we get a plate current of 1.5 mA.

If we now decrease the plate voltage to 33 volts, we shall reduce our plate current, when grid is at zero to 0.8 mA.

We can, however, bring the plate current up to 1.5 mA. again by increasing the grid voltage by only 3 volts positive.

So we see that an increase of 3 volts on the grid is equal to an increase of 21 volts on the plate; by employing the grid we have obtained a seven-fold amplification.

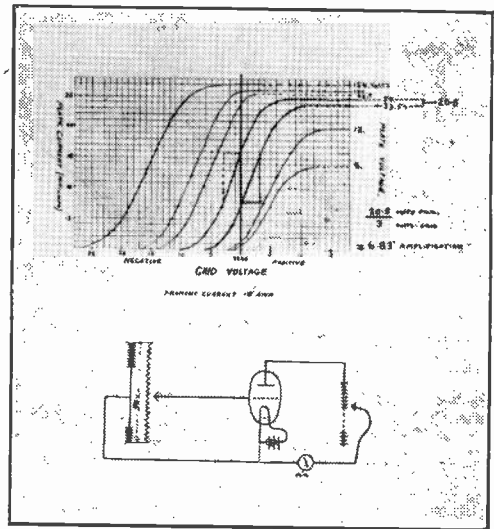

Fig. 5.

Manchester Wireless Society Transatlantic Tests.

For the information of those interested, the call letters of the 1k.W. station are 5 MS, and the transmissions take place at 1 a.m. to 1.15 a.m. each Sunday, repeating the message at 2, 3, 4, 5 and 6 a.m. Reports will be welcomed by the Hon. Secretary.

Sunday, November 19th. At 1 a.m. the members commenced a special series of tests with a 1,000 watt valve transmitter, calling 2 FP and 1 AW, two American amateur stations. Transmission lasted for 15 minutes and consisted of test messages referring to the work in hand. These were repeated every hour until 6 a.m., the intervening 45 minutes of each hour being devoted to listening for replies from the above-mentioned stations. The power was derived from D.C. generators, in series, with a total output of 2,500 volts, and using two 450 watt Marconi valves, a maximum radiation of 12 amps was attained on the last transmission.

As regards the reception, although 23 American amateur stations were registered, there was no acknowledgement of our transmissions. One special record was an amateur as far west as California, who was only using about 750 watts and radiating about 7 amps. The number of stations heard in one period of listening compares favourably with the results obtained with the special station erected by Mr. Paul Godfrey in Scotland last winter, and certainly reflects great credit on the gentleman who designed the receiver, and also on the work of the members who designed and erected the aerial.

Cables are being exchanged between the American Radio Relay League and the Society with a view to boosting up the enthusiasm which has been aroused on both sides of the Atlantic, and the Manchester amateurs are working day and night

improving their apparatus with a view to eventually establishing direct interchange of messages, to be followed by a special test of telephony, subject to the approval of the P.M.G.

Another test was held on November 26th.

Further Colliery Experiments.

Mr. A. Trevelyan Lee (2 DJ) experimented recently with Mr. S. Grimwood Taylor (2 IX) at the Denby Colliery, near Derby.

Tests were made early in October. A temporary single wire aerial was erected at the top of two ladders, with a bare copper wire lying on the ground for an earth. One set was placed in a tub, lined with boards, and sent down the shaft. The aerial down below was suspended from the roof with string. Communication was immediately established with the station at the colliery office on top, speech and gramophone music coming through loudly and distinctly. This station was about 100 yards from the foot of the shaft. The tub was then pushed along the rails for about a mile, and communication was again easily established, but the signals from below were less clear. Mr. Lee said he understood that the strata above the coal consisted of iron deposits in nodule form.

The power employed did not exceed 5 watts, and was derived from one of Newton's Bros. generators, working off a 12-volt accumulator. One of the sets used choke control and the other grid control. Three valves were used for reception, one being the resistance-capacity coupling (long wave type) and the other tuned choke and L.F. The wavelength was 440 metres.

During discussion at the Derby Wireless Club it was suggested that a much longer wave might be found more satisfactory, and it was understood that this had been found to be so in submarine work.

Questions and Answers

NOTE.—This section of the magazine is placed at the disposal of all readers who wish to receive advice and information on matters pertaining to both the technical and non-technical sides of wireless work. Readers should comply with the following rules:—(1) Each question should be numbered and written on a separate sheet on one side of the paper, and addressed "Questions and Answers," Editor, THE WIRELESS WORLD AND RADIO REVIEW, 12/13, Henrietta Street, London, W.C.2. Queries should be clear and concise. (2) Before sending in their questions readers are advised to search recent numbers to see whether the same queries have not been dealt with before. (3) Each communication sent in to be accompanied by the "Questions and Answers" coupon to be found in the advertisement columns of the issue current at the time of forwarding the questions. (4) The name and address of the querist, which is for reference and not for publication, to appear at the top of every sheet or sheets, and unless typewritten, this should be in block capitals. Queries will be answered under the initials or town of the correspondent, or, if so desired, under a "nom de plume." (5) In view of the fact that a large proportion of the circuits and apparatus described in these answers are covered by patents, readers are advised before making use of them, to satisfy themselves that they would not be infringing patents. (6) Where a reply through the post is required, every question sent in must be accompanied by a postal order for the amount of 1s., or 3s. 6d. for a maximum of four questions. (7) Four questions is the maximum which may be sent in at one time.

"C.M.S." (Finchley) asks (1) What are the advantages and disadvantages of capacity reaction compared with magnetic reaction. (2) Can capacity reaction be used in such a manner that the aerial circuit will not radiate. (3) and (4) For a diagram using capacity reaction.

(1) It is easier as a rule to obtain reaction effects using a reaction coil, but when the resistance capacity method of H.F. amplification is used it is often convenient to use the capacity reaction method. The reaction condenser generally has a maximum capacity of 0.0001 mfd., and is connected between the grid and plate of the 1st and 3rd or 2nd and 4th valve. (2) You could arrange

H.T. variable up to 75 volts. The grid condenser should be 0.0003 mfd., and grid leak 2 megohms. A fixed condenser of 0.001 mfd. should be connected across the telephones, and a variable condenser with a maximum capacity of 0.0002 mfd. should be used to tune the primary of the H.F. transformer. (4) We do not think so.

"H.K." (Malden).—You could use plug-in honeycomb coils, or if you prefer, wind cylindrical coils yourself. The A.T.I. could be 5" diameter and 8" long, full of No. 22 D.C.C. The closed circuit inductance could be 4" diameter by 8" long, full of No. 26 D.C.C. The tuned anode coil

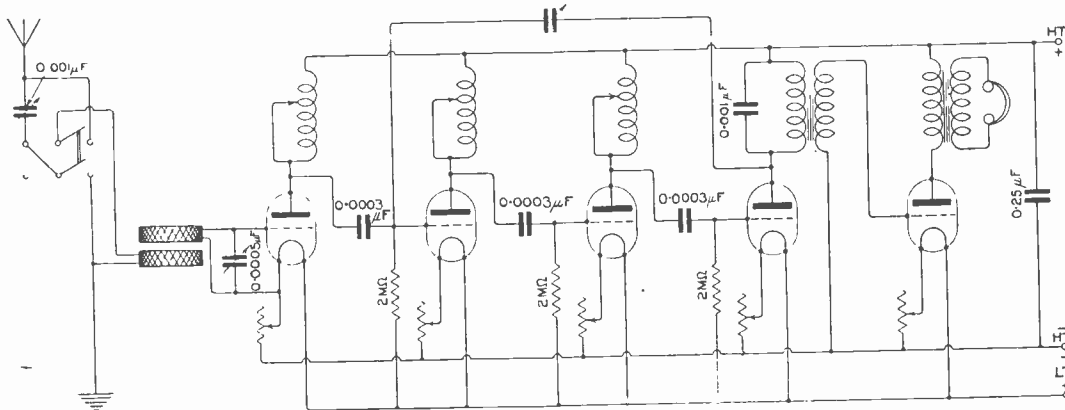

Fig. 1.

the capacity reaction between the grid of the 2nd and the plate of the 4th valves. (3) See Fig. 1. (4) See recent issues.

"A.T.G." (Peckham) asks (1) For criticism of his circuit. (2) Whether we can suggest improvements. (3) Whether the values are correct. (4) Whether the provision of a switch to cut out reaction will enable him to secure the P.O. permission to use the set.

(1) (2) and (3) The diagram is quite correct. The filament battery should be 6 volts, and the

and the reaction coil should be of the plug-in type, and you could experiment and find the best values yourself. About four sets of coils are required. The intervalve transformer should be made up exactly as described in the issue of August 19th, 1922. The core is 2½" long, 7/16" diameter, and is bent over the windings. The total length of the core is 10". The primary winding is of No. 46 S.S.C. and is wound on until the diameter is 13/16", and the secondary winding of the same wire is wound over the primary until the diameter is 1¼". See page 659, 19th August, 1922.

"A.D." (Manchester).—(1) The method is not "roundabout" as you suggest. Oscillations are maintained by the mutual coupling of L2 and L3. It is immaterial which coil is in the grid and which is in the anode, and also in which circuit the tuning condenser is placed. The theory of the oscillation is almost the same in each case. Oscillations having been set up, it is almost immaterial which of the coils is used for transferring them to the aerial circuit. (2) Eccles' "Continuous Wave Telegraphy" is probably the best theoretical book for your purpose. It does not contain any very heavy mathematics, but is by no means an elementary work. (3) Only the Post Office can say whether you are qualified for an experimenter's licence.

"T.A.L.D." (Woking) asks for a diagram of a set to fulfil certain conditions. (2) If the set will receive certain stations. (3) If a certain make of slab coils could be used in place of honeycombs. (4) What is the lowest wavelength used.

(1) See the diagram (Fig. 2). (2) PGGG probably, 2 MT and FL certainly, but 8 AB very doubtful. (3) If desired, but slab coils are considerably less efficient than true honeycombs. (4) The lowest value used for ordinary purposes is about 150 metres, but a certain amount of special work is

brushes connected to the H.T. commutator, and the machine will deliver about 1,200 volts D.C. The H.T. commutator probably has a far greater number of commutator bars than the L.T.

"G.E." (Morecambe).—We have examined the circuits submitted, and we prefer circuit No. 1. The grid condenser should be 0.0003 mfd., and the grid leak 2 megohms. The closed circuit inductance is of course tuned with a variable condenser of 0.0005 mfd. maximum value. We suggest you connect a fixed condenser of 0.001 mfd. across the L.F. transformer in the detector valve circuit, and another of 0.025 mfd. across the H.T. battery. You may find it very much better to use a 6-volt accumulator instead of the 4-volt shown.

"WEENIE" (Colchester) asks (1) and (2) For a criticism of his circuits submitted. (3) Whether the circuits will function on short wavelengths.

(1) The circuit is quite suitable provided you handle the reaction properly. (2) In the second circuit no reaction is used, but this does not mean you cannot receive telephony. (3) Each circuit is suitable for the reception of short wave telephony, but we prefer circuit No. 1.

"LESLIE" (Mitcham) (1) Submits a sample of wire and asks whether it is suitable for use in a short

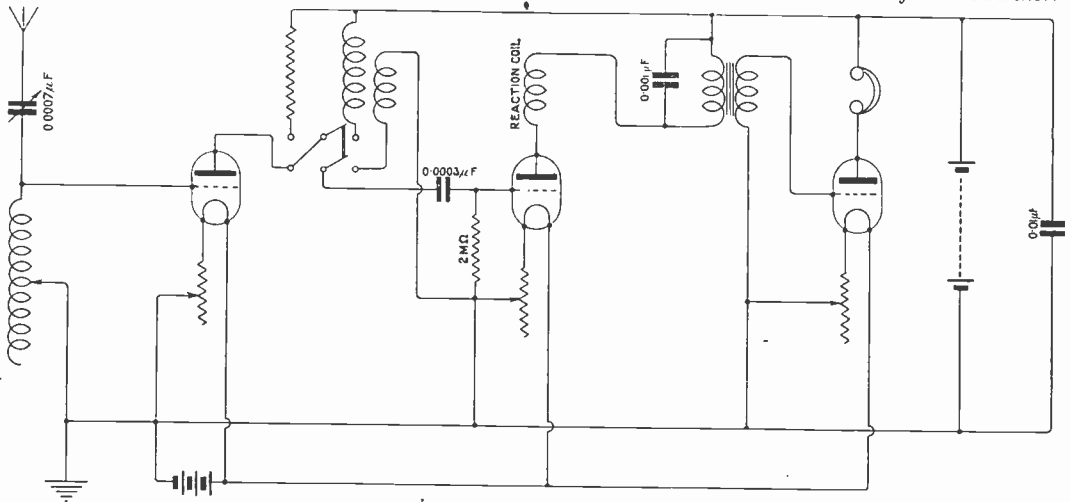

Fig. 2.

done on wavelengths of about 10 metres. This involves the use of highly specialised methods, and it must be regarded as almost impossible for an amateur to listen in on such work.

"INTERESTED" (New York) asks (1) The most convenient method of converting a B.T.H. set for short wavelength reception. (2) For a description of R.A.F. transmitting and receiving telephony set. (3) For description of his machine, of which particulars are supplied.

(1) We suggest you communicate with the manufacturers of this receiving set. (2) We cannot undertake to provide a description of a complete wireless outfit in these columns. (3) The machine is probably a rotary transformer. A 12-volt accumulator should be connected to the low tension side of the machine. This supply also energises the field. The H.T. output is taken from the

wave coil. (2) and (3) For particulars of a long wave tuner.

(1) The wire submitted is No. 31 S.W.G., D.S.C., and is therefore too fine for use in a short wave coil. We suggest you wind a coil 4" × 4" of No. 22 D.C.C., taking six tapplings. (2) and (3) For the long wavelength coil we suggest you wind a former 6" diameter and 10" long full of No. 26 D.C.C. taking about 12 tapplings. You should use a 0.001 mfd. variable condenser in series with the short wave coil for tuning short wavelengths, and then connect the condenser in parallel with the large coil for tuning long wavelengths. The reaction coil could be a coil of No. 26 D.C.C. 3" diameter and 5" long with 3 tapplings. As you suggest, you could connect the long-wave coil in series with the short-wave coil when you wish to receive very long wavelengths.

MAGNAVOX

THE WORLD'S FINEST

LOUD SPEAKER

RADIO
brings it
MAGNAVOX
tells it.

*Broadcasting faithfully reproduced
with marvellous clarity and volume*

IMMEDIATE DELIVERY.

To be obtained from all dealers or direct from the
Manufacturers & Sole Licensees

Sterling Telephone & Electric Co., Ltd.

TELEPHONE HOUSE,

210/212, Tottenham Court Road, London, W.1

Telephone No. : 4144 Museum (7 lines) Telegrams : "Cucumis, Wesdo, London."

Works : DAGENHAM, ESSEX.

BRANCHES : NEWCASTLE-ON-TYNE : 9, Clavering Place.
CARDIFF : 8, Park Place.



No. R1282
(18" Horn)

YOUR
ENQUIRIES
INVITED.

YOUR WIRELESS SET IS ONLY AS EFFICIENT
AS YOUR BATTERY IS RELIABLE,
THEREFORE ALWAYS USE

HART BATTERIES

SUITABLE FOR
HIGH AND LOW TENSION CIRCUITS.

IMMEDIATE DESPATCH FROM STOCK OF FOLLOWING TYPES:—

TYPE	Volt- age	AMPERE HOUR CAPACITY		APPROXIMATE OVERALL DIMENSIONS			TYPE OF BOX	NET PRICE EACH	
		Contin- uous	Inter- mittent	WIDTH	LENGTH	HEIGHT		Cash with Order.	Carriage Paid
P.L. 3	2	1	2	27/32"	2 1/8"	3"	CELLULOID	3s. 0d.	2s. 6d.
"	2	1	2	1 5/32"	2 11/16"	3 1/2"	EBONITE	6s. 0d.	5s. 8d.
"	2	1	2	1 1/2"	1 3/4"	4 1/2"	GLASS	5s. 3d.	5s. 0d.
E. 5	2	5	10	1 3/4"	1 3/4"	6"	GLASS	6s. 9d.	6s. 3d.
A.P. 7	2	11	22	1 3/8"	1 3/8"	6 1/2"	EBONITE	6s. 0d.	5s. 9d.

THESE CELLS CAN BE SUPPLIED MADE UP IN BATTERIES OF ANY REQUIRED VOLTAGE. SPECIAL
PRICES FOR SUCH BATTERIES WILL BE QUOTED ON APPLICATION.

HART ACCUMULATOR CO., LTD.
STRATFORD, LONDON, E.15

BRANCHES:
 BELFAST .. 41, CHICHESTER STREET
 BIRMINGHAM .. 174, CORPORATION STREET
 BRISTOL .. 37, VICTORIA STREET
 GLASGOW .. 107, WELLINGTON STREET
 LONDON .. 36, VICTORIA STREET, S.W.1
 MANCHESTER .. 4, VICTORIA BRIDGE
 YORK—6, BRIDGE STREET

The "BROWN" Loud Speakers

With New Improved Curved Horns

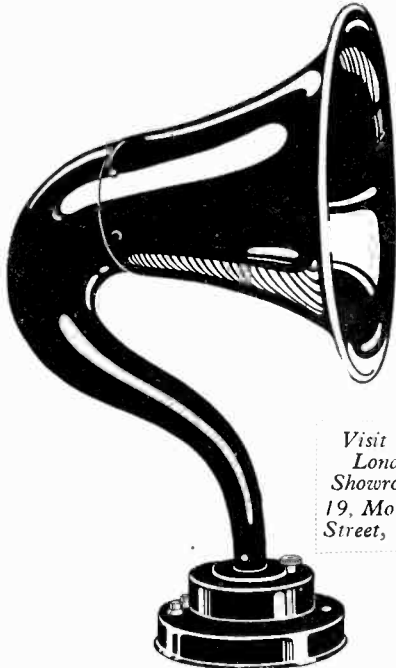

Visit Our
London
Showrooms:
19, Mortimer
Street, W.1

H.2 (Small Size) Height 12"

THE "BROWN" MICROPHONE AMPLIFIER

THIS AMPLIFIER magnifies signals, speech, or music, without distortion, and is of considerable interest to amateurs and scientific investigators. This magnification is much greater than that obtained from a two-valve amplifier. In construction, this instrument

is much more robust than other relays. This instrument satisfies the urgent demand for a reliable, inexpensive amplifier, which the most inexperienced amateur can use, and which the most experienced requires. The necessary transformers are included in the base.

PRICES : Low Resistance (120 ohms input) £6 0 0
High Resistance (2,000 ohms) input 6 2 6

SOLE MANUFACTURERS—

S. G. BROWN, LTD.

Head Office and Works—

VICTORIA ROAD, NORTH ACTON, LONDON, W.3.

London Showrooms—

19, MORTIMER STREET, LONDON, W.1.

Telegrams—"Sidbrownix, London."

Telephone—Chiswick 1469.

Sole Agent for the Argentine—

Horacio D. Guerrero,
Las Heras 2480, Buenos Aires.

THE REQUISITES of a Loud Speaker are pure tone, clear articulation, and good volume of sound. The "BROWN" Loud Speaker possesses these qualities and they are enhanced by the new improved curved horn.

AMATEURS do not always need the full sized Loud Speaker (H.1) as used in Lecture Halls, and a small type (H.2) has been designed to meet their more modest home requirements both as to volume of sound and price.

THE NEW HORN of dull blacked aluminium used with both H.1 and H.2 is constructed on the logarithmic law of increasing openings and is acoustically perfect.

PRICES :

H.1 (Large) Low Resistance,
120 ohms, height 21" £6 5 0

H.2 (Small) Low Resistance,
120 ohms, height 12" £3 0 0

(High Resistances for either
size - - 2/6 to 5/- extra)

CATALOGUE POST FREE

"INTERESSE" (Brussels) refers to the Armstrong receiver described in the October 21st and 28th issues for (1) Particulars of the variometer used in the Armstrong super-regenerative circuit. (2) Values of 200, 1,250 and 1,500 turns D.L. coils, and if single layer coils have to be secured in any particular position. (3) What is the wavelength range of the set described.

(1) The stator of the variometer is made in two parts, each part is $4\frac{5}{8}$ " square and $1\frac{1}{8}$ " long,

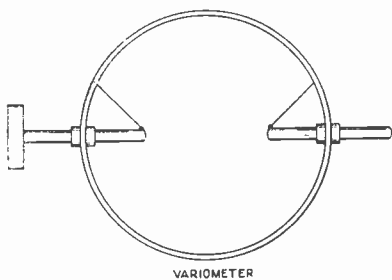
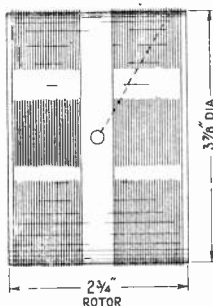
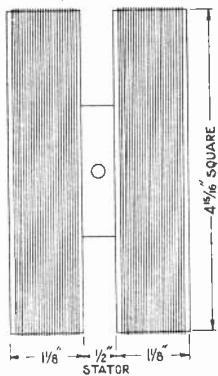

Fig. 3.

and 26 turns of No. 22 D.C.C. are wound on each half. The rotor is $3\frac{7}{8}$ " diameter and $2\frac{3}{4}$ " long, and each side is wound with 27 turns of No. 22 D.C.C. wire. The shaft of the rotor is made in two parts; one part is secured to each side of the rotor. The rotor connections are taken one to each shaft, and springs connect the shaft with terminals. The inductance of this variometer is 31 mhs. at minimum, and 538 mhs. at maximum. (See Fig. 3.) (2) The approximate inductances are:—200 turns=2,600 mhs.; 1,250 turns=10,000 mhs.; 1,500 turns=15,600 mhs. Single and multi-

layer coils could of course be constructed to have those inductances. (3) The coils should be fixed in the exact positions indicated in the article, and it is always better when constructing sets according to a description given in the Journal, to follow out all instructions precisely. (4) The wavelength range of the set is about 300 to 700 metres.

"P.S." (France) asks (1) For a list of the proposed British broadcasting stations and their hours of working. (2) Whether the Armstrong super-regenerative circuit is suitable for receiving 2,600 metres.

(1) It is proposed broadcasting stations shall be located in London, Plymouth, Cardiff, Manchester, Glasgow, Birmingham. (2) The Armstrong regenerative circuit as described in recent issues of this journal is only suitable for receiving short wavelengths. See reply to **"INTERESSE"** (Brussels).

"L.H." (Huddersfield).—To construct a variometer making use of the scheme described on page 130, you will need two cards cut to the design shown, wound with coils all in the same direction. The two inside ends of two opposite coils on each card are joined together, which now leaves four ends for the two cards. Two of these ends are joined together, and the other two are terminals of the variometer. Be very careful with regard to direction of winding. The four coils on the two cards must oppose each other when in the short wave position, and assist when turned through 180 degrees.

"C.E.H." (Birmingham).—We regret we cannot tell you the capacity of the condenser without a knowledge of the size of the plates and spacing washers. If the moving plates are $2\frac{3}{4}$ " diameter and 20 S.W.G. thick, and the spacing washers are $\frac{1}{8}$ ", the capacity will be 0.0004 mfd. We think you would be permitted to use the reaction coil coupled with the aerial coil when using the electric light main, but you should first of all communicate with the Electric Light Company. The microphone is quite suitable, and usually three dry cells or a 4-volt accumulator will provide sufficient energy.

"R.J.G." (Leighton Buzzard).—We suggest you use a number of each of the stampings, building them up until the core is roughly circular in cross section. The core should be $\frac{1}{2}$ " in diameter. The two sections of stampings should butt one against the other, and should be firmly held together after the winding is completed. A bobbin should be made which will just slide over the central core, and the primary winding should consist of No. 46 S.S.C. wire wound for one-third the window space, and the secondary should be wound with the same wire and fill the remaining space. It is not necessary to treat stampings with shellac. The stampings are already insulated sufficiently well with paper.

"W.L.M." (Belfast).—The proposed arrangement will not be satisfactory, because no provision is made for breaking the filament circuits of the valves not in use; neither can the secondary of an intervalve transformer work efficiently when connected to the input circuit of a valve, or to the telephones. Unless the jacks possess small capacity, losses will occur in the H.F. circuit, and in any case it is better to use switches with widely spaced contacts.

"ANTODYNE" (Huddersfield) asks (1) For criticism of his circuit. (2) The cause of poor results. (3) How to add one H.F. valve.

(1) and (2) The diagram of connections is correct, but it would be better if you used a secondary circuit. The A.T.C. should be connected in series with the A.T.I. when receiving short wavelength signals, and as you hear nothing except when the A.T.C. and A.T.I. are in parallel, the value of the A.T.I. is wrong. A suitable coil for short wavelength reception would be a coil of No. 22 D.C.C. wound on a former 4" diameter and 5" long. The secondary would be a coil of No. 26 D.C.C. It would on a coil of 3" diameter and 5" long. It must be remembered that a single valve working as a detector does not give results much superior to those obtained when a good crystal combination is used. (3) See Fig. 4.

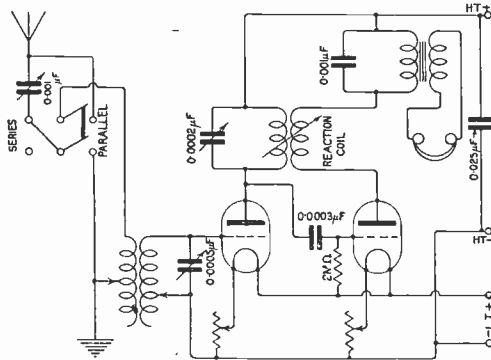

Fig. 4.

"BRADD" (Fulham) asks for a diagram of a two-valve set.

See reply to "ANTODYNE" (Huddersfield) above.

"W.D." (Lewes).—As you suggest, the terminal immediately below the H.T. terminal should be the L.T.+ (page 144, October 28th issue, referred to). If a common L.T. battery is used when other units are connected, the H.T.— connection should be made to the L.T.— instead of the L.T.+ as shown.

"F.B." (Sheffield).—We have examined the diagram of connections and find it correct. We assume the fixed condenser joined across the transformer primary has a capacity of about 0.001 mfd. The values of the components are suitable, but we do not think you can expect the valve to produce better results than a crystal when used as a detector. We suggest you use the crystal as a detector and the valve as a note magnifier.

"A.R.E." (Rugby).—Oscillations will be set up in a circuit containing a valve when the output and input circuits are coupled, and the energy supplied from the plate circuit to the grid circuit is sufficient to make the effective resistance of the grid circuit negative. If the valve is just on the point of generating oscillations, a slight circuit adjustment will probably cause oscillations to commence. If however, the circuit is quite

steady, e.g., due to the presence of a damping current in the input circuit, the coupling between plate and grid may be increased without sudden oscillations being generated. When using the tuned anode arrangement, the grid condenser and leak are joined to + L.T. to provide this grid current.

"T.M." (Salford).—We have examined the printed diagram submitted, and it is quite wrong. In the first place, a single filament resistance is shown controlling the temperature of two filaments, which is not very satisfactory. As different valves, even of the same type and make, require different filament currents in order to get the best from the valve, we suggest you use a filament resistance for each. The second error is, the telephones are joined in series with the primary of the transformer connected in the anode circuit of the second valve. This is quite wrong of course. Another point is the reaction coil is coupled with the secondary circuit inductance. Holders of the broadcast licence are not permitted to use a circuit of this type, and it is better for experimenters to employ reaction coupled between the first and second valves. It is useless to expect good results on short wavelengths when the A.T.C. and A.T.I. are in parallel. They should be in series. A number of circuits have recently been given in this journal, showing the connections of H.F. and L.F. valves, and we recommend you to adopt the tuned anode method of H.F. amplification, and couple the reaction coil to the anode coil. Better results are obtainable than when the H.F. transformer method is used. Articles showing the construction of H.F. transformer and H.F. anode coils are given in the issues of September 2nd, 16th and 30th.

"S.M." (London).—(1) We suggest you construct one of the many receiving sets described in this journal at different times. A very good set is that described in the issues of August 26th and September 2nd, entitled "A Broadcast Receiver," by Bull. (2) You will not experience any difficulty if the aerial is built away from the roof. It should be as high and long as possible, consistent with the Post Office regulations.

"SPARKS" (Wembley) asks (1) How to increase the wave range of the set described on page 554, July 29th issue. (2) The maximum capacity of variable condensers.

(1) It is simply necessary to connect larger coils in the aerial circuit, and make proportional alterations to the dimensions of coils L_1 and L_2 . (2) The capacity of the small condenser is 0.00063 mfd., and the capacity of the large condenser is 0.0017 mfd.

"NEW READER" (Sunderland).—(1) The aerial could have about 80 turns, the closed circuit coil 100, and the reaction coil 100 turns, No. 22 S.S.C. (2) To tune up to 1,100 metres you would require a number of basket coils connected together, and to avoid this we suggest you wind honeycomb coils. Try 60 turns of No. 22 on a 2½" former. (3) The bobbin should be wound with 160 turns each for primary and secondary. You may find it necessary to experiment a little to find the optimum value.



MARCONI
GIVES
UNRIVALLED
WIRELESS
SERVICE

The MARCONI INTERNATIONAL
MARINE COMMUNICATION CO. LTD.
MARCONI HOUSE, STRAND, LONDON



Single Valve Note Magnifier



Two Valve Note Magnifier

“BRITWIRE” NOTE MAGNIFIERS

By using one of these Note Magnifiers the telephony received on your crystal or valve set will be tremendously increased in volume.

Each Magnifier has an input transformer, thus rendering the use of a telephone transformer unnecessary where H.R. Phones are used.

PRICE, INCLUDING B.B.C. ROYALTY.

Single Valve Note Magnifier £4 - 0 - 0

Two Valve Note Magnifier .. £7 - 0 - 0

Three Valve Note Magnifier £9 - 15 - 0

All “BRITWIRE” valve apparatus is licensed under Marconi patents for amateur use in Great Britain.

BRITISH WIRELESS SUPPLY CO., LTD.

London Offices and Showrooms:—64, Frith Street, Shaftesbury Avenue, W. 1.

HEAD OFFICE: 6, Blenheim Terrace, Leeds. Telephone: 26926.

And at—18, Eldon Square, Newcastle.

Telephone - Newcastle-on-Tyne 360 City.

33, High Street, Southampton.

Telephone - Southampton 403.

11, Church Street, West Hartlepool.

Telephone - West Hartlepool 373.

8, Corporation Street, Belfast.

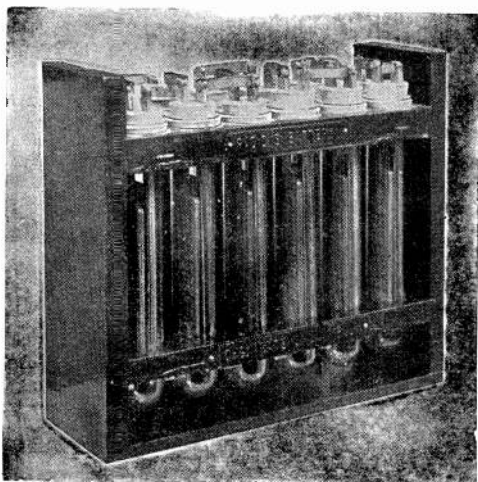

THE **Chloride** ELECTRICAL STORAGE
COMPANY LIMITED

Exide

H.T. BATTERIES

for

VALVE SETS

TYPE B.K. 24v, 28v, or 32v.

Owing to the demand for these batteries all orders will be dealt with in strict rotation. Prices approximately one shilling a volt. Ask for Leaflet 4030.

Clifton Junction, Near Manchester
219-229 Shaftesbury Av., London, W.C.2

"SPARKS" (Bradford) has trouble with his crystal set, and asks for advice.

We have examined the connections submitted, and we suggest you tune the aerial circuit with a 0.001 mfd. variable condenser, and the closed circuit with a variable condenser of 0.0005 mfd. The H.T.C. should be in series with the H.T.I. when short wavelengths are being received: otherwise the set is correctly connected. For the short wavelength range we suggest you wind an aerial coil of No. 26 D.C.C. $4\frac{1}{2}$ " diameter and 6" long, taking 10 tapings, and the closed circuit coil may consist of a coil $4" \times 6"$ of No. 26 D.C.C. with tapings. The wavelength range of your present set is from about 300 metres to 3,000 metres.

"H.T.C." (Epsom) submits a list of apparatus in his possession, and asks for a suitable two-valve diagram.

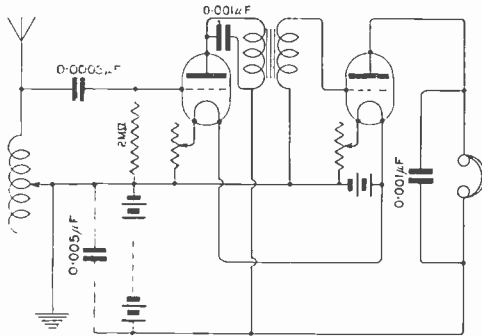

Fig. 5.

(1) See Fig. 5. (2) We suggest you use the two basket coils in the aerial circuit and the single basket coil and variometer in the closed circuit. (3) The method of construction proposed is quite suitable, and we suggest you wind 6 coils of No. 26 D.C.C., each coil having 40 turns. The wire should be wound side by side and spaced $\frac{1}{8}$ ". (4) We cannot say which is the primary or secondary winding of the transformer, and you must test for yourself, or write to the makers for information.

"F.R.H." (Barnwood) asks (1) For criticism of his set. (2) For particulars of construction of telephone transformer. (3) Whether certain valves will work together. (4) Size of sample of wire submitted.

(1) The connections are correct. The reaction coil should be coupled to the closed circuit coil. (2) A suitable open circuit telephone transformer may be constructed with the following materials: Coil 3" long, $\frac{1}{2}$ " diameter. Primary winding, 3 ozs. of No. 44 S.S.C., secondary winding 3 ozs. No. 34 S.S.C. The primary winding is wound on the core first, and the secondary is insulated from the primary with two or three sheets of thin paper. (3) The valves mentioned will work together. (4) Sample of wire is No. 44 D.S.C. copper.

"J.L.K." (Croydon) is building a valve transmitter and asks for criticism of set and other questions.

We do not care for the proposed scheme of connections, and we suggest you see the reply to "T.S.F." (Herne Hill), page 806, September 16th, 1922.

"E.E." (Cambridge) refers to the one-valve Armstrong super-regenerative circuit, and asks

(1) Size of slabs to replace honeycombs shown. (2) Whether a loose coupler may be used. (3) Particulars of choke. (4) If an "Ora" valve is suitable.

(1) We suggest you wire the slab coils with the same number of turns and the same mean diameter as the honeycomb coils. (2) The loose coupler is quite suitable for this purpose. (3) The choke could be an intervalve transformer with the windings connected in series, or you could rewind the transformers with No. 38 S.S.C. wire. An alternative would be to wind 5,000 turns of No. 38 S.C.C. wire on an iron wire core, $\frac{1}{2}$ " diameter and 3" long. (4) "R" valves give good results. Use 80 volts on the plate.

"A.E.W." (Wilts) asks (1) Whether his method of connecting up the components is satisfactory. (2) Does the set comply with the regulations.

(1) We have examined the diagram of your set submitted, and it is correct. You may not be able to receive 2 MT and 2 LO because the tuning arrangements will not tune down to this wavelength, and as we have no particulars of your coils you will have to satisfy yourself as to their suitability. We suggest you reconnect your set, using the diagram on page 147, October 28th issue. (2) If you hold an experimenter's licence the circuit should not be objected to. However, reaction cannot take place if you use the diagram given above.

"G.W.B." (Kent) asks for advice.

We think the cracking noise which you hear is due to loose or broken connections. If the H.T. battery is old it will cause the set to be noisy. You should carefully examine the whole outfit. The diagram submitted is correct.

"O.F.B." (Northampton) asks (1) For criticism of his set. (2) The value of capacities used. (3) For dimensions of coils. (4) Voltage of L.T. and H.T. batteries.

(1) The diagram of connections is correct except that the A.T.C. is omitted. We expect this is a clerical error. The A.T.C. should have a maximum value of 0.0012 mfd., and should be in series with the A.T.I. when receiving short wavelengths. The anode tuning condenser should have a maximum value of 0.0002 mfd. The grid condenser should be 0.0003 mfd., and the by-pass condenser across the telephones should be 0.001 mfd. (2) You will have to experiment and determine the best valves for yourself. The primary and secondary of the H.F. transformer should be about the same dimensions, and you might commence with a winding of 80 turns. The reaction coil should be about the same size as the secondary of the transformer. (4) Use a 6-volt L.T. battery, and 70-volt H.T.

"E.H.T." (Buxton).—(1) The diagram is correct, and if you hold an experimenter's licence, would no doubt be approved by the Post Office. (2) The capacity of a fixed condenser if two plates ($3" \times 3"$), separated with a 0.002" sheet of mica, is about 0.0075 mfd. (3) The sample of wire submitted is No. 26 D.C.C. We cannot say the wavelengths of your basket coils, as the inductance of a basket coil varies so much with the method of wiring, spreading, etc. However, probably they will take from 300 to 550 metres. (4) The telephone transformer could consist of the following:— $1\frac{1}{2}$ " diameter 3" long of iron wires, primary 3 ozs. No. 44 S.S.C.; secondary, 4 ozs. No. 34 S.S.C.

"H.G.K." (Bucks) wishes to wind a number of cylindrical coils to tune from 600 to 30,000 metres.

We suggest for the shorter wavelengths you join the A.T.C. and A.T.I. in series. The A.T.I. could be a winding of No. 22 D.C.C. on a former 4" diameter and 5" long, with 8 tapings. The secondary could be of No. 22 D.C.C. on a former 3½" diameter and 5" long with 5 tapings. The next largest coil may be a winding of No. 26 D.C.C., 4" diameter and 7" long, with 10 tapings, and the secondary of No. 28 D.C.C., 3½" diameter and 8" long, with 6 tapings. The largest coil may be of No. 28 D.C.C., 6" diameter and 10" long, with 18 tapings, and the secondary of No. 30 D.C.C., 5½" diameter and 12" long, with 8 tapings.

"F.S." (Kent) submits particulars of his set and asks for criticisms.

The proposed arrangement is suitable, but it would be better to connect the A.T.C. and A.T.I. in series when receiving short wavelengths. The variable condenser which tunes the anode coil should have a maximum value of 0.0002 mfd. The results obtained for a circuit of this description are quite satisfactory, and reaction effects are under proper control. The circuit is, we think, likely to meet with the approval of the Post Office. The A.T.I. could be a 120-turn coil with mean diameter of 2½", and the anode and reaction coils could each be a 100-turn coil.

"H.H.Mc.M." (Manchester).—With reference to page 706, August 26th issue, reply to "W.G.B.G." the reaction coil may consist of 100 turns of No. 40 S.S.C. copper wire with a mean diameter of 2". When receiving longer wavelengths more inductance will be required, and this may be added in the form of separate coils which do not have to be coupled. You may certainly use resistance wire for the H.F. transformer. The result will be, tuning is broader, and the wavelength range for given dimensions will be slightly greater than if copper wire is used. We cannot give precise values for the winding of H.F. transformers, but you should remember when experimenting, 600 turns for both primary and secondary wound on a tube 1½" diameter gives an optimum wavelength of 600 metres. We suggest you see the articles on "Experimental Station Design" in the issues of September 2nd, 16th and 30th. The primary winding may be tuned with an air dielectric condenser of maximum value 0.0002 mfd. We do not think you will find it necessary to use a condenser in conjunction with the reaction coil, but if any difficulty is experienced in obtaining reaction effects, a small condenser may be used. The stampings are quite suitable for use as the core of a L.F. transformer. The coil should be built up until the depth is ¾". The primary winding should be of No. 44 S.S.C. copper wire, and be wound until the depth of winding is ¾", and the secondary should be No. 46 S.S.C. copper wire, wound over the primary to a depth of ½". When using the resistance capacity method of H.F. coupling, the reaction coil should be coupled to the closed circuit coil. The resistances are best purchased, and should have a value preferably about 80,000 ohms. The second valve is coupled to the third by the reactance capacity method. The reactance coil and tuning condenser

are proportioned so as to tune with the wavelength of the signal. It is an advantage to use potentiometer control, as if the set is oscillating an adjustment can be made to stop the oscillations. We suggest one for controlling the grid potential of the first two valves. The valves will be satisfactory, and the aerial is good.

"F.W." (Birmingham) asks for criticism of his set and advice.

It is essential for the secondary circuit to be tuned with the primary circuit, and a tuning condenser is therefore necessary. The fact of hearing loud pops in the receiver when the aerial terminal is touched indicates the set is oscillating, and you should reverse the connection of the reaction coil. The alteration in the connections of H.T.—to the L.T. is necessary, of course, in view of the fact that the remainder of your apparatus is so connected. To determine the correct adjustments, it would be very helpful if you use a wavemeter fitted with a buzzer.

"C.E.D." (Ipswich) refers to the Armstrong super-regenerative circuit, and asks whether it is necessary to line the case with tinfoil.

We do not consider it necessary to line the interior of the instrument case with tinfoil. By so doing you may remove a little interference, but it is hardly necessary to make this refinement. The tube, as you suggest, is 3" diameter and 4" long. You will of course only use the set when connected to a frame aerial.

"J.A.R." (Manchester) asks (1) Whether bichromate cells will be useful for heating valve filaments (2) For a diagram of the simplest valve set. (3) Why he does not receive short wavelength signals while he gets long wavelength signals.

(1) These cells are hardly suitable because the potential falls off rapidly after a little use. (2) We suggest you see Fig. 7, page 217, November 11th issue. Fig. 2, page 183, November 4th issue, and Fig. 2, page 145, October 28th issue. (3) We suggest the tuning arrangements are not correct. If the A.T.C. is 0.001 mfd., and is in series with A.T.I., the A.T.I. may consist of a coil of No. 22 D.C.C. 3" diameter and 5" long, with tapings.

"SAPPER" (Swanage).—The coils will tune from 200 metres to 1,500 metres, the condenser being used in series when receiving on short wavelengths and in parallel when signals on longer wavelengths are being received.

SHARE MARKET REPORT

Prices as we go to press on November 24th, are:—

Marconi Ordinary	£2 4 9
,, Preference	2 2 6
,, Inter. Marine.. ..	1 7 3
,, Canadian	9 9

Radio Corporation of America:—

Ordinary	17 6
Preference	13 7½

ORA

The Valve for perfect reception

For receiving vocal and instrumental items you must have Mullard "ORA" Valves to get the best results.

Oscillates — Rectifies — Amplifies
Specially recommended where good detection and amplification are required.

15/- each

IMPORTANT NOTICE.

The great demand for Mullard "ORA" valves and other accessories has compelled us to open much larger works.

The "ORA" Valve requires about 3·8 volts on the filament and 30 volts or over between the anode and filament for efficient results.

The MULLARD "R" Valve is now reduced in price from 22/6 to 17/6.

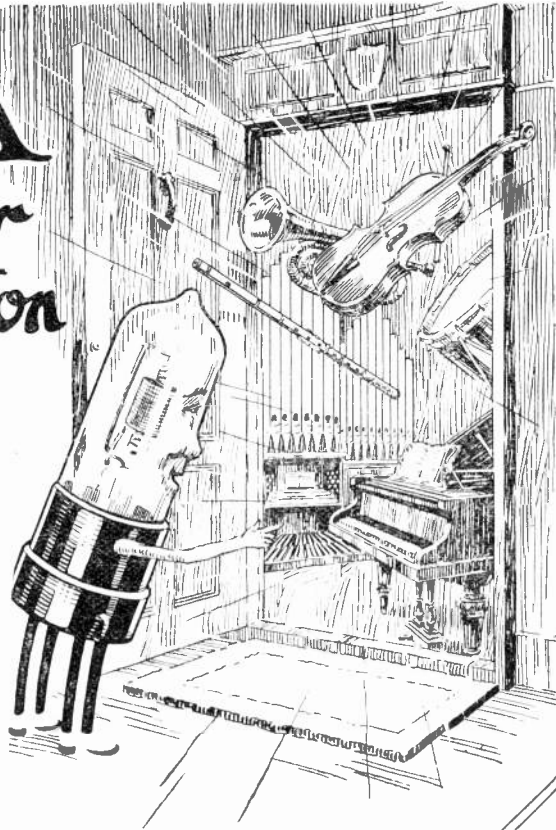

Mullard Radio Valve Co., Ltd

45, Nightingale Lane, Balham, S.W.12.

Contractors to H.M. Admiralty,
War Office, Royal Air Force &
Post Office.

Telephone: Codes: Telegrams:
Battersea ARC (5th Ed.) Radiovalve
1068 Bentley's Hammer Lond.



Name and Address
To the
MULLARD RADIO
Valve Co., Ltd.,
45, Nightingale Lane,
Balham,
S.W.12.

Please send me post free:

- Quantity
- Description
- Telephone Head Sets
- ORA Valves
- Grid A Resistances
- Anode A or B Resistances
- B A Combined 1000 mfd
- Combined Resistances
- Valve Bases with Conductor
- Valve Sockets
- Terminal Clips
- Name of usual Wireless dealer:

Price
35/- per set
15/- each
" " " "
2/6 " " " "
7/6 " " " "
5/6 " " " "
9d. per pair

I enclose (Cheque,
Money Order, P.O.) Value
to cover the
cost.

**SEND THIS
TO-DAY.**

We have just completed The LARGEST PURCHASE of EX-GOVERNMENT
WIRELESS MATERIAL

ever handled by an individual firm.

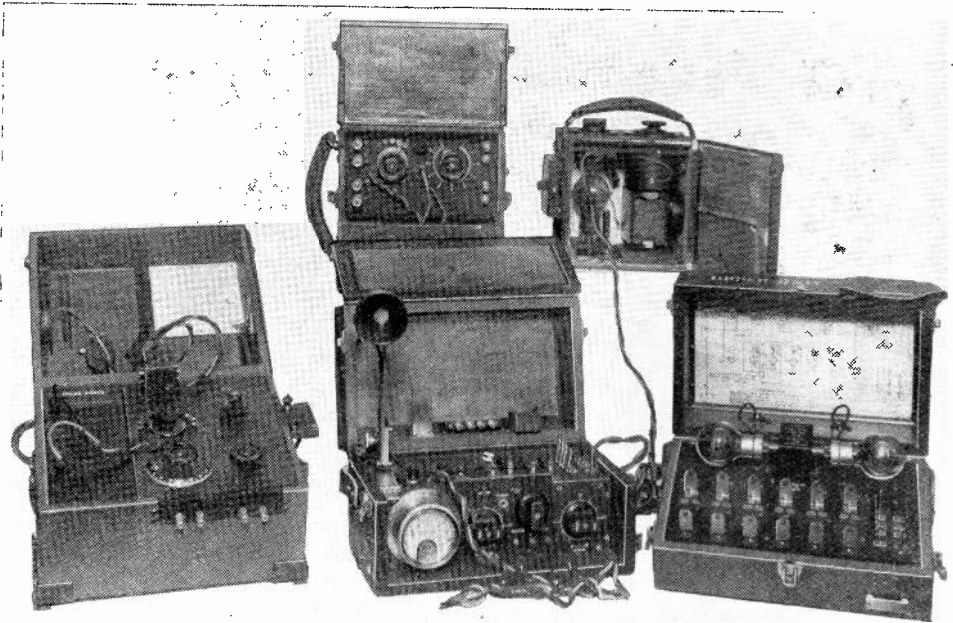

Receivers C.W.
Mark III

C. Mark IV Amplifier
Transmitting Set Unit No. I

Heterodyne Wavemeter
Transmitting Set No. II

The above illustration shows a few of the instruments acquired by us from the Disposal Board. They are all brand new and unused and a better class of article has never before been placed on the market.

It is our intention to offer the whole of this stock at astonishingly low prices in accordance with our inevitable rule to **SHARE OUR BARGAINS WITH OUR CUSTOMERS**

and we would again emphasize the fact that it is

**UNNECESSARY TO PAY FANCY PRICES FOR
EX-DISPOSAL BOARD WIRELESS APPARATUS**

A perusal of the following pages will convince everyone of the extraordinarily good value of these items

THE CITY ACCUMULATOR CO.

79, MARK LANE, LONDON, E.C.3

Telephone : AVENUE 1316.

We have the largest and most up-to-date wireless showroom in London, and inspection is cordially invited.

WE SHARE OUR BARGAINS WITH OUR CUSTOMERS.

Receivers, C.W. Mark III.

This set, illustrated on the previous page, comprises a complete two-valve receiving set with a wavelength range of 350-1,800 metres. The addition of high and low tension batteries, valves and 'phones, completes the entire receiving station. For the reception of broadcast concerts this set is ideal, the strength and clarity of the signals being absolutely wonderful. London readers should take the opportunity of hearing this set working at our Show-rooms. ONLY 200 LEFT. Price .. 9 9 0
 Complete with 4-volt 40-amp. Fuller block accumulator, 60-volt H.T. battery, 2 Mullard "ORA" valves, and pair of Brown "A" Type headphones, complete with cords 15 10 0

shall be pleased to forward a copy containing this article to any reader desirous of same upon receipt of postcard.

The C. Mark IV Amplifier is an improvement on the C. Mark III (the latter being sold by other dealers at £6 5s. each without cases) inasmuch as the C. Mark IV contains terminals and change-over switch, allowing the use of the instrument for either high or low frequency amplification.

The price at which we are offering these amplifiers is less than the actual value of the transformers contained in the instrument.

PRICE, COMPLETE IN MAHOGANY CASE 4 5 0

Amplifiers, C. Mark IV.

As illustrated on the previous page. This instrument is a complete three-valve low frequency amplifier and can be used in many ways without modification.

In the issue dated November 18th of the "Amateur Wireless," there appeared a very instructive article headed "Using Surplus W.D. Apparatus." This article very fully and clearly explains the many uses that may be made of this amplifier. We

C.W. Transmitters, Mark III, 30 Watt.

For two valves. Complete with aerial ammeter, platinum-pointed Morse key, in mahogany case. Wavelength range 300-1,800 metres.

Note.—This set can be conveniently converted into a two-valve DETECTOR-AMPLIFYING RECEIVER.

PRICE 3 5 0

The CITY ACCUMULATOR CO.
 79 Mark Lane, E.C.3

AVENUE 1316
 " 9936
 Phones " 91
 " 92
 " 93

WE SHARE OUR BARGAINS WITH OUR CUSTOMERS.

B Mark II Receivers.

Vertical pattern. Can be easily converted £ s. d.
to any wavelength. (See Mr. Philip
Coursey's recent article in "The Wireless
World and Radio Review," which
fully explains the conversion of this
particular type.)

The instrument contains intervalve trans-
former, valve-to-phone transformer,
condenser and grid leak, filament re-
sistance, change-over switch and two
valve holders.

PRICE 3 15 0

Above fitted with variable air condenser,
·0005 mfd., in place of change-over
switch 4 15 0

**Heterodyne Wavemeters.
500-3,000 Metres.**

As illustrated. Containing variable con-
denser, change-over switch, valve holder,
coils, etc., complete with calibrated chart.

For Receiving, without galvanometer.. 2 0 0

For Transmitting and Receiving, con-
taining Weston Galvanometer.. 3 0 0

**Complete Radio Telephony
Transmitting and Receiving
Installation.**

As illustrated, comprising—

Unit No. 1, fitted with Microphone, £ s. d.
Milliamperemeter, change-over switch,
etc.

Unit No. 2, containing six-valve Receiver,
3 H.F., 1 Detector and 2 L.F., Micro-
phone Transformer, control choke, etc.

Unit No. 3, cable for connections.

Unit No. 4, Hand Generator, 18 watt, D.C.
600 volt, 30 milliamps.

PRICE FOR THE COMPLETE STATION, 25 0 0

Aerial Masts and Equipment.

15' Steel Masts in Sections, each 2' 8½",
complete with halyard, pulley and stays.
Can be erected by one man and are portable.
The height can be increased up to 30' by
the use of extra stays.

Per SET COMPLETE 0 15 0

30' ditto in sections, each 4' 3" (without
stays).

Per SET COMPLETE 0 17 6

INSULATED AERIALS, 40' 0 1 0

60' 0 1 6

*Kindly note that the above prices do not include packing
and carriage. Please add, therefore, an appropriate
amount to cover this. Any surplus will be refunded.*

The CITY ACCUMULATOR CO.
79 Mark Lane, E.C.3

Phones { AVENUE 1316
" 9936
" 91
" 92
" 93

WE GUARANTEE EVERY CUSTOMER'S SATISFACTION OR CASH RETURNED.

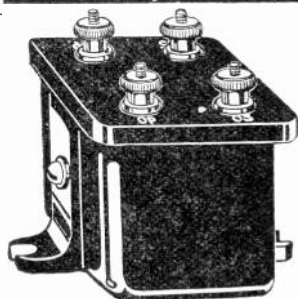

AMAZING OFFER OF

SULLIVAN HEADPHONES 12/6

120 ohms. Brand new and unused **PER PAIR**

Complete with Telephone Transformer (as illustrated) **30/-**

NOTE.—These Transformers, if sold separately, are 25/- each.

BROWN'S HEADPHONES

"A" Type. ALUMINIUM DIAPHRAGMS. 120 ohms

42/6

PER PAIR

Complete with Transformer, as above **55/-**

SULLIVAN 8000 ohms 36/6

Postage 1/- per pair extra.

CORDS, best quality, 3/6.

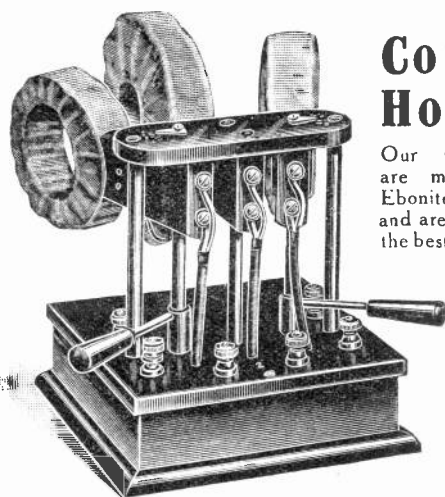

Coil Holders

Our Coil Holders are made in solid Ebonite, matt finish, and are beyond doubt the best on the market

25/-
EACH

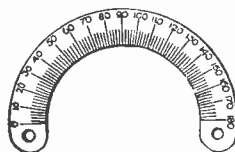

Variable Condensers

We have every confidence in offering these Condensers as the best obtainable.

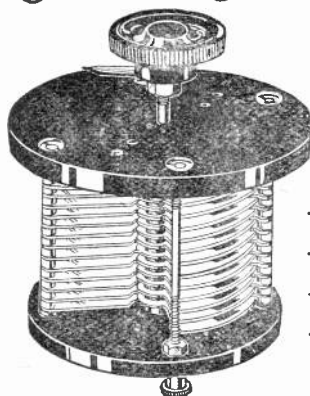

'0005 mfd. (panel).. **18/6**
'0005 mfd. (in case) **20/-**
'001 mfd. (panel).. **24/6**
'001 mfd. (in case) **26/6**

The CITY ACCUMULATOR CO.
79 Mark Lane, E.C.3

Phones { AVENUE 1316
" 9936
" 91
" 92
" 93

BLOCK TYPE ACCUMULATORS

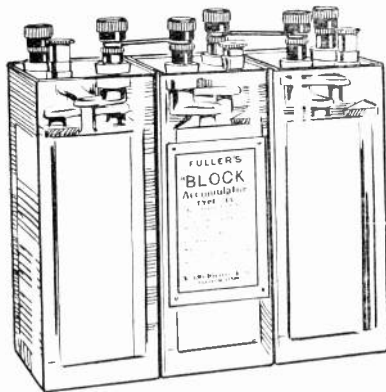

Type 640, £2 8 9

A SUMMARY OF THE PRINCIPAL ADVANTAGES OF BLOCK ACCUMULATORS.

- (1) They are "fool-proof."
- (2) There are no plates to buckle.
- (3) It is impossible for the cells to be spoilt through accidental short-circuiting, and even if the terminals are joined by a metal bar, the cells will not be spoiled or seriously injured.
- (4) They will retain their charge for many months.
- (5) Sulphating cannot occur to any serious extent, as this is mostly caused through cells standing in a discharged state or being discharged through accidental short-circuits.
- (6) The blocks are so constructed that they cannot swell or grow and this prevents the external box or container being cracked or broken.
- (7) If the cells are neglected, or left in charge of inexperienced hands, no serious harm can be done, as even when discharged down to 1.5 volts, they recover their voltage and maintain their recovery, thereby preventing sulphate forming.
- (8) They are lighter and have a higher capacity per pound weight than ordinary plate accumulators, and can be re-charged an indefinite number of times.

WHY WE CAN SELL BELOW THE MAKERS' PRICES.

Some time ago we purchased an exceedingly large stock of "Block" Type Accumulators from the Government on terms which permitted our re-selling them at a much reduced price. During the last two years, we have disposed of several thousands in all parts of the world and most of the largest and best known electrical firms are numbered amongst our customers.

During this period, we have built up, on sound business lines, probably the largest Accumulator business in existence. We buy only on the largest scale and no opportunity escapes us so long as the quality of the stock is right. We have Accumulators direct from the manufacturers' works, to the value of several thousand pounds and being content with a small margin of profit on a large turnover, we are able to offer these world-famous cells for re-sale at a considerable saving to the customer.

It is our inevitable rule to share any bargains with our customers, and our system of business will be to put money into the pockets of those who deal with us. It is on these principles that our business has reached its present magnitude.

A perusal of the following prices and comparison with the cost of the identical article if bought in the ordinary way, will show the considerable saving which can be effected by dealing through us.

TYPE.	VOLTS.	Intermittent capacity at 20-hours rate.†	Maker's Price.	Our Price.	TYPE.	VOLTS.	Intermittent capacity at 20-hours rate.†	Maker's Price.	Our Price.
			£ s. d.	£ s. d.				£ s. d.	£ s. d.
2 B K	2	16	0 9 6	0 7 0	B L 255	2	110	2 0 6	1 7 6
4 B K	4	16	0 19 6	0 14 0	B L 455	4	110	4 1 0	2 15 0
6 B K	6	16	1 8 6	1 1 0	B L 655	6	110	6 1 6	4 2 6
240	2	40	1 7 6	0 16 3	B J 2120	2	120	2 4 0	1 8 0
440	4	40	2 15 0	1 12 6	B J 4120	4	120	4 8 0	2 16 0
640	6	40	4 2 6	2 8 9	B J 6120	6	120	6 12 0	4 4 0
B L 12a	4	50	2 12 6	1 16 0	B L 280	2	160	2 4 6	1 12 6
B L 13a	6	50	3 18 0	2 18 0	B L 480	4	160	4 9 0	3 4 0
					B L 680	6	160	6 13 6	4 16 0
2 A D 9/s	2	64	1 2 6	0 18 0	B L 2110	2	220	3 0 6	2 0 0
4 A D 9/s	4	64	2 5 0	1 16 0	B L 4110	4	220	6 1 0	4 0 0
6 A D 9/s	6	64	3 7 6	2 14 0	B L 6110	6	220	8 9 0	6 0 0
2 A D 9/c	2	70	1 6 3	1 0 0	For those who require a cheaper Accumulator of the plate type, we can offer FULLER'S STANDARD PLATE TYPE BATTERIES as under.				
4 A D 9/c	4	70	2 12 6	2 0 0					
6 A D 9/c	6	70	3 18 9	3 0 0					
B L 240	2	80	1 15 0	1 4 0	S L 230	2	30	0 11 6	0 9 0
B L 440	4	80	3 10 0	2 8 0	S L 430	4	30	1 9 0	0 18 0
B L 640	6	80	5 5 0	3 12 0	S L 630	6	30	2 3 6	1 7 0
B L 21	4	94	3 8 0	2 12 0	S L 280	2	80	1 3 0	0 14 0
					S L 480	4	80	2 0 0	1 8 0
					S L 680	6	80	3 9 0	2 2 0

† Note :—The Ignition Capacity is double the Actual Capacity taken at the 20-hour rate.

Prices for Teak Carrying Crates or Cases on application.

The name "FULLER" is behind every one of these batteries, a certain guarantee of quality, for nothing but the best and purest materials are used in the manufacture of their products.

The CITY ACCUMULATOR CO., 79, Mark Lane, E.C.3

AVENUE 1316
9936
Phones— " " 91
" " 92
" " 93

AGENTS—London: A. V. ALBROW, 56, George Street, Portman Square, W.

Glos.: BRISTOL WIRELESS CO., 52, Cotham Hill, Bristol.

S. Wales: SOUTH WALES WIRELESS INSTALLATIONS CO., LTD., 18, West Bute Street, Cardiff.

Lancs.: ALL-BRITISH WIRELESS MANUFACTURERS CO., LTD., 18, Vauxhall Road, Liverpool.

THE Marconiphone

The MARCONIPHONE V.2. PRICE £25 : 0 : 0

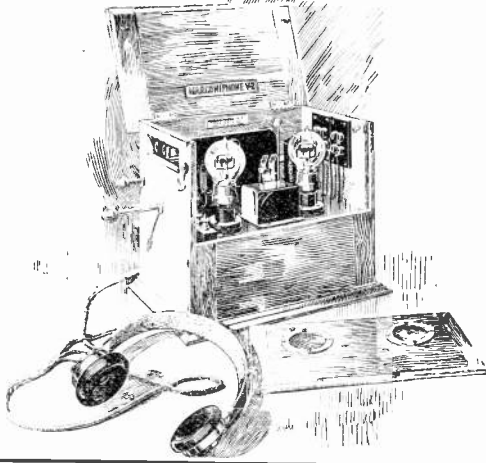

RECEIVING MODELS
FOR
BRITISH BROADCASTING

Incorporate unique features
which ensure perfect reception

Full compliance with
Government Regulations.

THE MARCONIPHONE DEPARTMENT,
MARCONI'S WIRELESS TELEGRAPH CO., LTD.
MARCONI HOUSE, STRAND, LONDON, W.C. 2

TEC

HIGH TENSION DRY BATTERIES for WIRELESS SETS

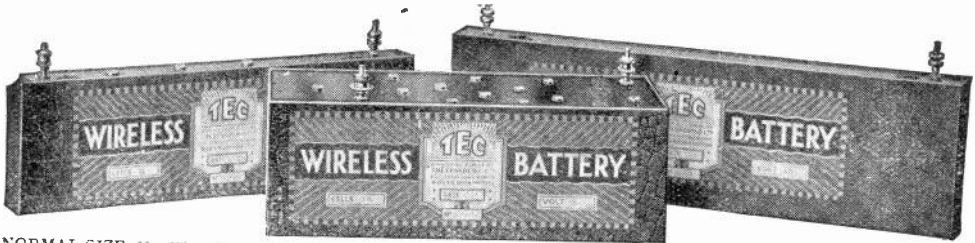

NORMAL SIZE, No. W 70 V, 15 Volts
Price 5/-

W 71 V, 50 Volts
Price 15/-

GIANT SIZE, No. W 73, 15 Volts
Price 6/6

SUPPLIED IN TWO SIZES FOR 15, 50 or 60 VOLTS
and with Tappings in 3 Volt Steps.

ALL BATTERIES FITTED WITH PLUG SOCKETS AND MOVABLE TERMINALS.

Complete Illustrated Price List on Application.

**THE EFANDEM CO., LTD., FALLINGS PARK WORKS,
DRY BATTERY MANUFACTURERS WOLVERHAMPTON**



BROWN'S

"Featherweight"

HEADPHONES

British and Best

The Finest Headphones Procurable for

30/-

This price is for one pair of either 120 or 4000 ohm 'phones, including cords of good quality.

TYPE F. "Featherweight."
Actual weight, including cords,
is 6ozs. only.

Catalogue Post Free.

Head Office and
Works :
Victoria Road,
North Acton, W.3

S. G. BROWN, Ltd.

London
Showrooms :
19 Mortimer St.,
London, W.1

MODERN WIRELESS

February

1/-

Vol. 1

Edited by JOHN SCOTT-TAGGART, F.Inst.P.

No. 1

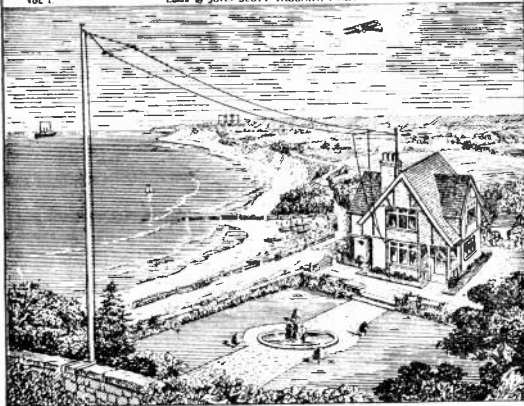

THE GREAT NEW MONTHLY
WIRELESS MAGAZINE

PRELIMINARY ANNOUNCEMENT

This is to announce that on

JAN. 15th

the Radio Press will publish a
Monthly Magazine entitled

"MODERN WIRELESS"

It will be edited by

JOHN SCOTT-TAGGART, F.Inst.P.

assisted by

PAUL D. TYERS & E. REDPATH

Radio Press Ltd.

DEVEREUX COURT,
TEMPLE, LONDON, W.C.2

Carophon

"CLEAR AS
A BELL."

BROADCASTING RECEPTION SETS

P.O. LICENCE No. 0124.

CRYSTAL SETS One to Four Valve Sets

WE have prepared a range of BROADCASTING RECEPTION SETS conforming to P.M.G.'s Regulations and manufactured under Patentee's Licence. We invite applications for our "R" List, giving full particulars and prices. We are also prepared to offer special terms to Dealers in districts where Agencies have not yet been fixed.

LONDON—
8a & 9, Gt. Chapel St.,
Oxford St., W.C.1.

GLASGOW—
Mercantile Chambers,
85, Bothwell St.

Ward & Goldstone
PENDLETON. MANCHESTER

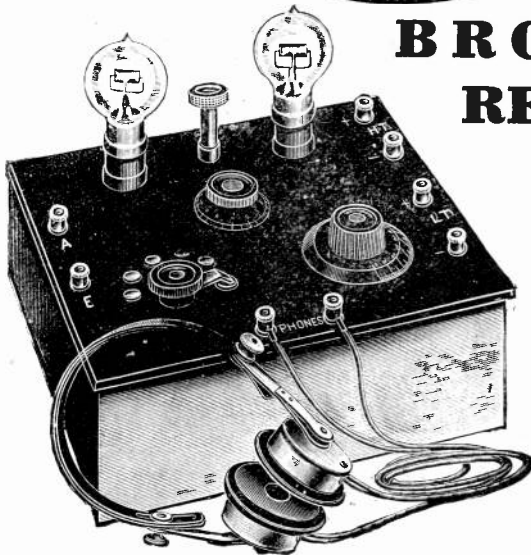

"For they are jolly good Fellows"

Precision Air Condensers

For series of parallel tuning use Fellows Precision Air Condensers. They are equally suitable for separate use or panel mounting. Made in four standard sizes.

- 0002 mfd. - - Price 16/- (postage 6d.)
- 0003 mfd. - - Price 17/6 (postage 6d.)
- 0005 mfd. - - Price 22/6 (postage 6d.)
- 00005 mfd. vernier Price 8/6 (postage 6d.)

*All Fellows radio components are British
Made throughout and fully guaranteed*

FELLOWS MAGNETO Co., Ltd.
LONDON, N.W.10.

Telephone—Willesden 1560-1.

Telegrams—Quixmag. Phone, London.

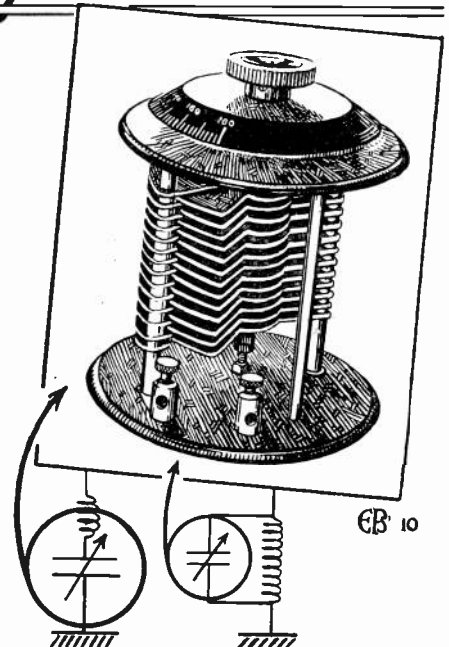



FREE
OUR NEW BIG-ILLUSTRATED CATALOGUE
RADIO SUPPLIES

16 Pages, handsome cover in three colours, gives you full information and prices on Wireless Receiving Sets complete from £3 10s. to £12 10s. Hear all the concerts, speeches, sermons, news, crop and weather reports, now being broadcasted daily. Costs you nothing after first cost. Easy to install and operate. And hundreds of other Wireless articles.
Write to-day. FREE.

PERMANENT ONLY CRYSTAL 7/6 DETECTOR Post paid

Ready to attach to your set.

Greatest boon ever known to Wireless Experimenters. Always ready, no fiddling or searching for a point. Crystal always active. Largest mail-order firm in Europe. **Important Notice.**—All our apparatus is guaranteed "your money back in full" if not satisfied. Write to-day.





BRITISH RADIO SALES CO. LTD
STEPHENS BUILDINGS, GRASSIE ST., RATHBONE PLACE, LONDON W.1.



GENUINE HELLESEN DRY BATTERIES



HIGH TENSION WIRELESS BATTERIES.



SPECIAL TRADE AND WHOLESALE TERMS

Code word.	Volts.	Details.	Price.
"WIRON"	15	Screw terminals	4/- each
"WIRTO"	15	Strip	4/- "
"WIRIT"	38	2 insulated wander plugs	8/6 "
"WIRIN"	80	2	14/- "

Wander Plugs and Terminals are included in the price of the Battery and are NOT AN EXTRA.

KNOWN THE WORLD OVER AS THE BEST.

ALL LISTS FREE ON APPLICATION.

A. H. HUNT, LTD.
H.A.H. Works, Tunstall Rd., Croydon, Surrey

Ediswan Valves.



Type AR

THE manufacture of Thermionic Valves is a highly skilled operation and every Ediswan Valve has behind it the experience and operative skill of over forty years of lamp making.

The AR Valve illustrated is specially made for Amateur reception. Plate voltage 30-80 volts. Filament volts 3.5-6.0 volts. Filament current 0.75 amperes. High amplification—silent working.

Price 15/- each.

Always ask for Ediswan Valves. If you are unable to obtain them at your Dealers write to us for the name and address of the nearest supplier.

THE EDISON SWAN ELECTRIC CO., LTD.,
Head Office: 123/5, QUEEN VICTORIA STREET, E.C.4.
London Showrooms: 123/5, Queen Victoria Street, E.C.4, & 71, Victoria Street, S.W.1.
Works: Ponders End, Middlesex.



HANG IT!

If you hang this Directory of land, ship and experimental call-signs from your table, you will have at your disposal a most useful list of the World's station calls.

Suppose, for example, you heard the call : **POZ POZ POZ de WSO WSO WSO** you would simply look up the Directory for WSO and immediately find out who was working.

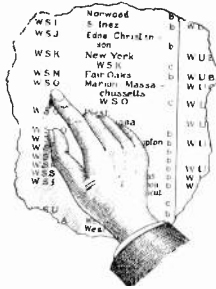

Thousands of other call-signs are given and you will be using this handy Directory, which is absolutely up-to-date, every time you listen-in. Every genuine experimenter, whether interested in Morse or Telephony, is buying a copy. **HAVE YOU BOUGHT YOURS YET?**

ORDER YOUR COPY TO-DAY!

From all booksellers or direct (post free 2/8) from

Radio Press Limited,

Publishers of Authoritative Wireless Literature,

DEVEREUX COURT, TEMPLE, W.C.2

EBONITE EQUIPMENT

FOR

WIRELESS SETS

SHEETS, KNOBS, COIL
HOLDERS, VALVE HOLDERS,
ENGRAVED DIALS, SOLID
EBONITE HORNS FOR
LOUD SPEAKERS, PANELS

FROM STOCK

HIGHTENSITE LTD.

Normandy St., Custom House, E. 16

Phone : EAST 3153.

WIRELESS TRAINING

Most thorough training in Wireless Telegraphy or Telephony given under ideal conditions.

Special Postal Course for Amateurs.

Prospectus Free.

WIRELESS APPARATUS

Complete stocks of all Wireless Instruments and Accessories. Prompt Deliveries. List 1½d. stamp.

WIRELESS COLLEGE COLWYN BAY

No Waiting. Delivery from Stock



Perry Head Phones
4,000 Ohms 21/- per pair

Specially designed for Wireless Telephony. Receivers arranged in series, Aluminium Cases and fitted with extremely light and efficient Head Bands, and Twin Connecting Cords.
Illustrated Wireless Catalogue now ready, post free 3d.

The JEARY Electrical Co., Ltd.
8, LAMBETH HILL & 97, Queen Victoria St., London, E.C.4

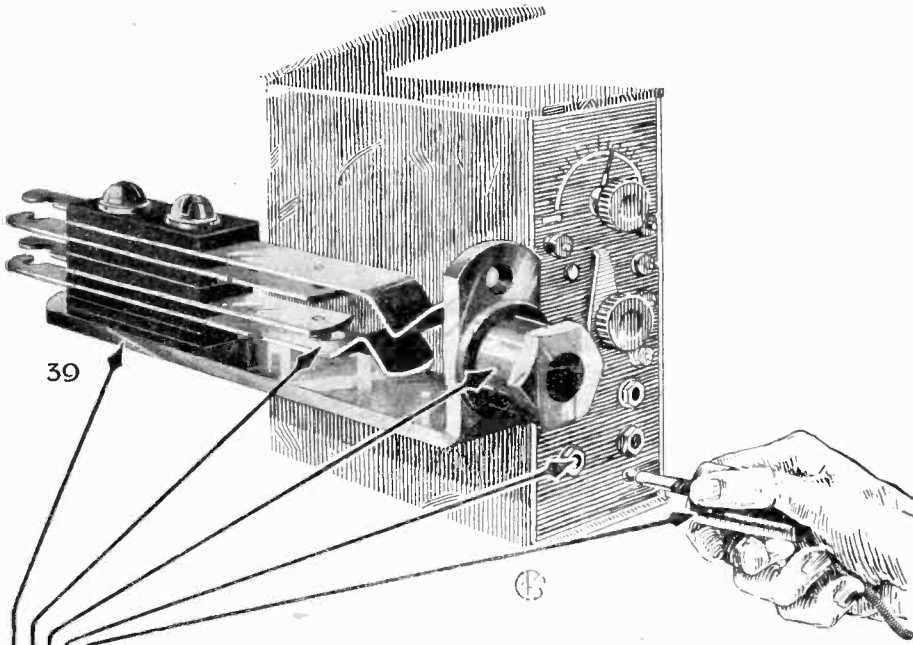

GET THE BEST OUT OF YOUR SET BY USING

THE ELWELL JACK SYSTEM

(a) Any standard telephone plug can be used but preferably the special spiral Elwell plugs which are fitted with self-tightening connection grips.

(b) The Jacks fit neatly on the panel and being heavily nickel plated aid considerably to its appearance.

(c) They are easily fixed to any panel up to $\frac{1}{8}$ " thick. No fixing screws are required.

(d) Five types of jacks are available from a simple telephone jack to one controlling telephone, transformer and filament battery.

(e) Insulation tested up to 1000 volts.

Once connected up on the Elwell Jack System your receiving set becomes far more convenient to use both for broadcast reception and for experimental purposes. The following operations become quite automatic:—

1. Filaments switched on
2. Telephones or loud speaker put across any desired number of valves.
3. Intervalve transformers disconnected at point of insertion so ensuring maximum efficiency.
4. Only the required number of valves light up. The remainder stay out of circuit.
5. Removing Plug completely switches off set. No errors can afterwards be made in connections or switching. Loose contacts and broken leads are permanently prevented. Comparative tests of telephones and loud speakers can be made with ease and accuracy

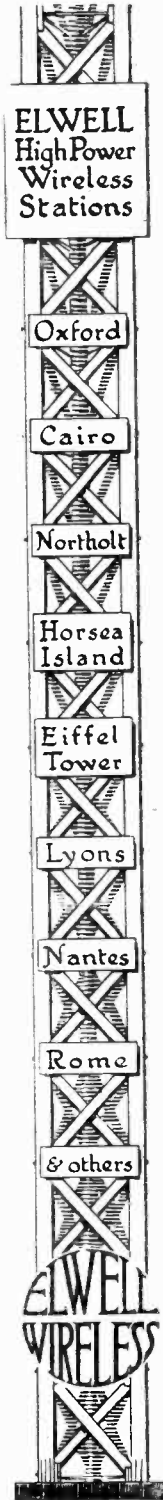

Write for descriptive leaflets.

C. F. ELWELL, LTD., *Radio Engineers,*
CRAVEN HOUSE, KINGSWAY, LONDON, W.C.2
 Telephone: REGENT 421.

GENTS' "DISCOL" H.F. TRANSFORMER

HAS
BECOME
A



STANDARD
FITTING

We will send literature on receipt of p.c.

in the RADIO WORLD and is in large demand by every class of user.

Ask your Dealer for Gents' "Discol" H.F. Transformer

6/8 each

Also Gents' Tangent L.F. Transformer, 22/6 each.

GENT & CO., LTD. Radio Dept., Faraday Wks., LEICESTER

LONDON: 25, Victoria Street, S.W.1

NEWCASTLE-ON-TYNE: "Tangent House," Blackett Street.

ACCUMULATORS HIGHEST QUALITY LOWEST PRICES

4 Volt 40 Amp. ..	18/6	6 Volt 40 Amp. ..	26/3
4 " 60 " ..	21/6	6 " 60 " ..	32/9
4 " 80 " ..	28/2	6 " 80 " ..	37/3
4 " 100 " ..	30/-	6 " 100 " ..	43/6

In celluloid cases.
SPECIAL LINES.

6 Volt 40 Amp. ACTUAL (88 igniting amp.) in three glass cells, sealed tops and in well-made teak crate with strap handle. ELEVEN PLATES per Cell .. 49/6
24 Volt HIGH TENSION Accumulator, complete in polished teak case .. 24/6

BARGAIN OFFER, 700 ONLY.

4 Volt 30 Amp. in celluloid cases, 13/- each, postage 1/8.
2 Volt 30 Amp. in celluloid cases, 6/9 each, postage 1/-.
GOOD DISCOUNT TO TRADE

KNIFE SWITCHES

On Ebonite.
S.P. S.T. D.P. S.T.
S.P. D.T. D.P. D.T.
As illustration 2/9 each.

COIL PLUGS

2/- each



HEAD PHONES 4,000 ohms, High Quality .. 22/6
WRITE FOR LISTS.

F. YATES & SON, LTD.,
144, Church St., Kensington, London, W.8

Phone, Park 4276. One Minute from Notting Hill Gate.
Central London and District Railways.

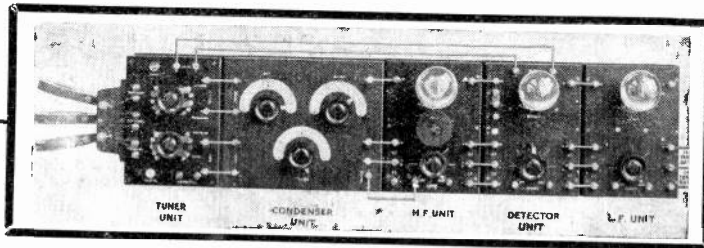

Splendid Valve Sets

Whether you can spend little or much, you will learn far more by building up your own Set. Our standardised Unit System permits you to add further Valves just as you wish. Well-designed instruments (in sets of parts with full instructions) can be built up in a few hours on the kitchen table without previous experience.

The amateur who is just beginning to take a serious interest in Radio, as well as the advanced experimenter, will both find that the Peto-Scott Unit System permits him to build up an efficient multi-valve Receiver according to

individual ideas. The price of a complete set of parts for the above 3-Valve Set (including 3-circuit Tuner, three Variable Condensers and full instructions for assembling) shows a tremendous saving over any ready-built 3-Valve Set.

Our new Booklet explains the whole system

POST 6^d FREE

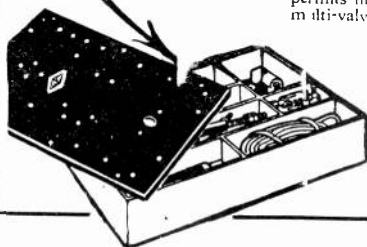

Offices and Showroom—
Featherstone House,
64 High Holborn,
W.C.1

Send stamp for 32-page
Illustrated Catalogue.



M.A.S.

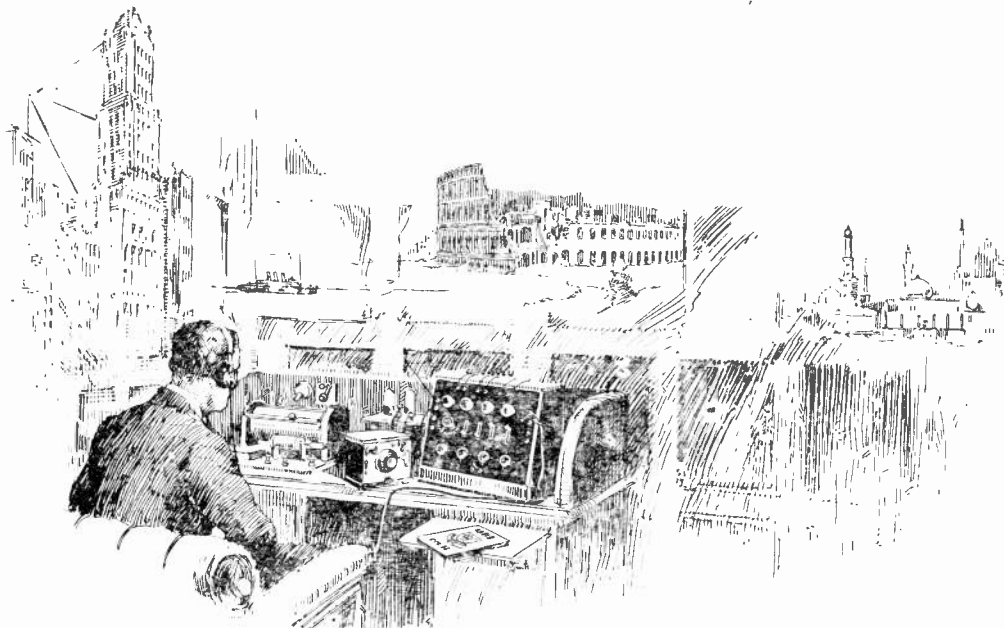

THE WORLD AT YOUR FEET.

New York, Rome, Constantinople and many other far flung cities may be brought into your rooms. You can listen to ships sailing under a clear sky on their way to the Indies; you can experience the romance of hearing stations thousands of miles away. You will need valves and you will need to know how to use them. Only by having a sound knowledge of valves can you hope to get the best results.

Whether you have had other books or not, you will find "WIRELESS VALVES SIMPLY EXPLAINED" (cloth 3/-, paper 2/6 net), a delight to read and an ideal source of information. If you already have this book, buy "PRACTICAL WIRELESS VALVE CIRCUITS," also by John Scott-Taggart, F.Inst.P., Member I.R.E. It costs 2/6 net and gives dozens of excellent tested circuits. It should be bought by everyone who has a book of any kind on valves. There is a limited number of a "de-luxe" edition at 3/- net each.

Some Instructional & Practical Books

"WIRELESS VALVES SIMPLY EXPLAINED"	2/6 net, post free	2/8
.. .. . Cloth	3/- "	3/3
"PRACTICAL WIRELESS VALVE CIRCUITS"	2/6 "	2/8
.. .. . Special Edition	3/- "	3/3
"CONSTRUCTION OF WIRELESS RECEIVING APPARATUS," by Paul D. Tyers. 3rd (enlarged) edition	1/6 "	1/7½
"ELEMENTARY TEXT-BOOK ON WIRELESS VACUUM(TUBES)," by John Scott- Taggart, F.Inst.P.	10/- "	10/6
"WIRELESS FOR ALL"	6d. "	7½d.
"SIMPLIFIED WIRELESS"	1/- "	1/1½
"WIRELESS DIRECTORY"	2/6 "	2/8

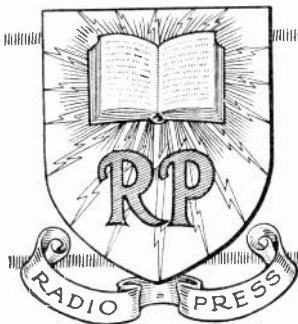

Radio Press, Ltd.

PUBLISHERS OF AUTHORITATIVE WIRELESS LITERATURE
DEVEREUX COURT, STRAND, W.C.2.

OPPOSITE THE LAW COURTS TEL. CENT. 4393



Series No. 2

Makers of over Half
the World's Telephones.



Western Electric

CRYSTAL
RECEIVING
SET.

The Western Electric Crystal Pattern Receiving Set has been specially designed and developed to meet the demand for a simple and inexpensive apparatus which will enable the amateur—without electrical knowledge—to take advantage of the local "Broadcast" programme. It is simple, inexpensive, and in its polished mahogany box with hinged lid, is compact and handy and looks well. A partition is included which holds the double head receivers. The set is complete with two spare crystals and has quite an excellent range. A most popular set.

Western Electric Company Limited.

62, Finsbury Pavement, London, E.C.2
Telephone—London Wall 7608

WORKS:—

North Woolwich, London, E.16
Telephone—East 3840 (10 lines)

Also at BEXLEYHEATH, KENT, and NEW SOUTHGATE, N.11

Birmingham—Grenville Buildings, 12, Cherry St.
Leeds—Standard Buildings, City Square.
Cardiff—Motor House Chambers, 1, Wood St.

Manchester—Northern Assurance Buildings.
Newcastle—20 Saville Row.
Glasgow—49, West Campbell Street.



The World-famous 'HELLESEN' Wireless Batteries

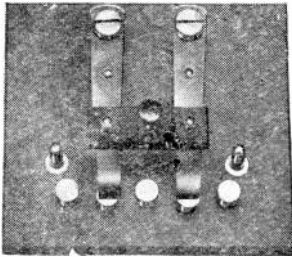

— High-grade —
Instrument finish
SWITCHES
Massive appearance
Laminated P. B.
Blades. Adaptable
as S.P. and D.P.,
also Series parallel
and reversing, **5/-**
as illustration, each

ACCURATE
range of Blocking
CONDENSERS
Best ruby mica
and polished ebonite. Complete or
sets of parts ready
to assemble.

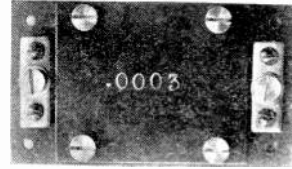

Price complete, up to
0C05 Mfd. 2/3 each
005 " " " " " 2/6 "

HIGH GRADE TUNING STANDS

in best quality ebonite and brass fittings, in best instrument finish. Ready to use straight away and fix anywhere, there being no flexible leads to give trouble. Long handles or knobs, same price.

Two Coil 14/-
Three Coil 17/6

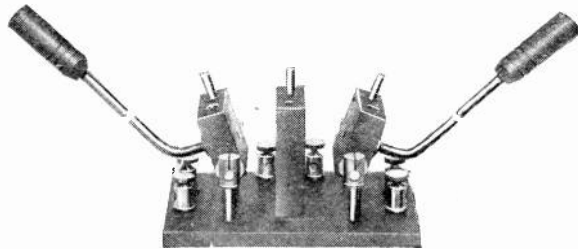

Special Terms to the Trade.

Guaranteed Accuracy and Finish.

Write for Lists.

J. E. DAWSON, Manufacturing Electrician, WEST STREET, BOSTON, LINCS.

"Castaphone" Apparatus for Broadcast Reception

Reg. Trade Mark

Approved by P.M.G. under seal and registered number.

"Castaphone" Crystal Receiver, G.P.O. Reg. No. 167

"Castaphone" T.I., G.P.O. Reg. No. 1017

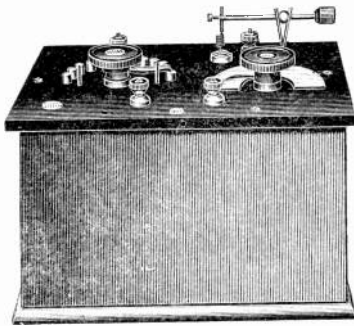

Wavelength range 300-500 metres.

A specially sensitive Crystal Receiver, Range 20-30 miles. A simple and effective instrument. Price **£3 5s.** Phones for above from **30/-**

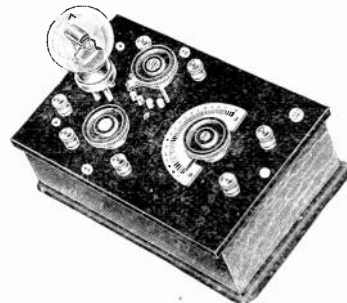

Wavelength range 300-500 metres.

"Castaphone" T.I. The most efficient one-valve set made. Effective range, 30-40 miles, and the most simple to work. Price **£5 5s.** less valve, or with phones, Marconi valve, batteries, and aerial wire and insulators, price **£10.**

Castaphone sets are not designed to compete with cheap apparatus which must be unsatisfactory in use.

They represent a standard in design, workmanship and results, that cannot be bettered.

"Castagnoli" valve apparatus are made under Marconi license. Write for full details:—

GORDON CASTAGNOLI, A.M.I.R.E. MANUFACTURER OF WIRELESS APPARATUS Braintree, Essex

Ex Government Apparatus

P.O. Relays	20/-
Weston Relays	25/-
Portable Masts, 4 Sections. With strong brass sockets, 11' 6", per set	7/-
18' Bamboo Masts	6/3
Strong Instrument Cases with hinged lid and handle, suitable for accumulators, sets, etc., teak and walnut ..	5/6
E.T.H. Microphones with 150w. receiver, with cord ..	5/6
Microphones with replaceable insets	2/6
120 Ohm Single Phones, with cords	4/-
Moving Coil Ampmeters, 0-10 amps, 5½" dial	15/6
1 and 2mf. condensers	1/6
30 Amp. China, quick break switches	5/-
One complete charging board, with reg. resistance, 8' ampeter to 10 amps, 8' voltmeter to 100 volts, Bridge type fuses, two-way switch, etc.	£6
Transmitting Helix in ebonite case, with coil in ebonite case, hinged, with engraved geared regular, etc. ..	10/-
Dublilier Condensers, in mahogany cases, for 25,000 volts	10/-
H.T. Battery Boxes, with lid with switch and terminals, etc.	5/-
Hand-Combination Telephones with Cord (New), microphone replaceable type	6/6
P.O. Sounders, ebonite bases, with 5 terminals	12/6
Mark III and Mark III* Crystals, in cups, per doz. mixed	3/6
Mark III and Mark III* Crystals in cups, per gross	30/-
Telephone Magnets, wound to 60 ohms, each, per pair	1/-

Other ex-Government lines in stock. Also new wireless apparatus of all kinds in stock. Send for requirements.

C. S. SWAN,
191, Bishopsgate, E.C.2
 (Under Brandons, Tailors), and 65, Windsor Road, Leyton, E.10.
 *Phone, Bishopsgate 1156.

BROADCAST-CRYSTAL RECEIVERS FOR WIRELESS TELEPHONY, Etc.

A RELIABLE INSTRUMENT AT A LOW FIGURE.

Double Slide Tuning Coil, Spring Contact Crystal Detector, Engraved Ebonite Panel, Lacquered Terminals, the whole fitted into solid well seasoned, polished mahogany cabinet.

As Illustration (Approximate Range 3,000 metres.) Post free
£4 : 5 : 0

Complete with Double Headphones, 100 ft. of Aerial Wire and 3 Insulators. Overseas Postage Extra.

All that is necessary with these sets is to connect up the aerial and earth and telephones and with small adjustment signals should be received.

Fully illustrated list post free 4d.



P. Office Approved Pattern No. 119.

Dimensions—6½ × 6½ × 5½. Approximate Weight—3 lbs.

H. D. BUTLER & CO., LIMITED.
 Office & Showrooms: Bank Buildings, 222, Gt. Dover Street, Borough, S.E.1
 Telephone: Hop 3029. Works: Canonbury, London, N.1.
 Works North 1838. Telegrams: "Ingenuity Phone, London."

The "Autoveyors" 3-ELECTRODE VARIABLE CONDENSER

(British Patent 17703/22)

is the most efficient precision controller of oscillations in radio circuits. It comprises three sections, each consisting of a tier of parallel plates of one-third disc area. The centre section is spindled and knobbed, and permits a variation of capacity over 360 degs. Both side sections are spindled and knobbed and permit Vernier control of extreme precision. Thus, whilst providing all the essentials of the ordinary 2-Electrode Variable Condenser, it affords the added advantage of the coupling of the third electrode, which may be applied in a thousand and one ways.

- In **Aerial Circuits** the 3-E.V.C. permits the application of capacity from Zero Series to Maximum Parallel by a single operation. Additional switches are unnecessary, and detuning from Series to Parallel is avoided.
- In **Closed Circuits** it provides a precision-controlled static coupling for synchronous super-regeneration or relay radiation choke of unbounded possibilities.
- In **Grid Circuits** it permits the employment of regenerative static influence upon the input.
- In **A.ode Circuits** it affords definite control of by-pass, stability and regenerative applications.
- In **Oscillator Circuits** the 3-E.V.C. ensures precision control of synchronism.

Full particulars from the Sole Patentees:—
AUTOVEYORS, LTD.
 Radio Engineers and Contractors
 84, Victoria Street, London, S.W.1
 *Phone: Victoria 309.

COMPARE OUR PRICES FOR RELIABLE WIRELESS COMPONENTS

POLISHED INSTRUMENT CABINETS Without Lids. Best Instrument Finish.

4" x 4" x 1"	4" x 4" x 1½"	4½" x 4½" x 3½"
1/6	2/-	2/6
Ebonite Lids	10d.	10d.
4½" x 4½" x 5"	7" x 5" x 3"	8" x 6" x 3"
3/-	3/6	4/3
Lids	1/-	2/3
10" x 8" x 3"	12" x 9" x 3"	6" x 5" x 5"
5/6	7/-	4/6
Lids	3/9	4/6

The last figure denotes depth of box. Prices of ebonite lids are for 3/16ths thick.

EBONITE CIRCULAR DISCS THESE ARE USEFUL FOR MANY PURPOSES.

Diameter	1"	1½"	2"	2½"	3"	3½"	4"
1/16" thick	1d.	1½d.	2d.	2½d.	3d.	3½d.	4d.
¼" "	1½d.	2d.	2½d.	3½d.	4d.	5d.	6d.
3/16" "	2d.	2½d.	3d.	4d.	5d.	6½d.	8d.
½" "	2½d.	3d.	4d.	5d.	6d.	8d.	10d.
¾" "	3d.	4d.	5d.	6d.	7½d.	9d.	1/-
1" "	3½d.	5d.	6d.	8d.	9d.	10½d.	—

It will pay you to send three stamps for our 32-page catalogue of wireless apparatus.
SAXON RADIO CO. The Leading Firm in the North for Wireless Apparatus
 Henry St. Works, South Shore, BLACKPOOL

J. L. Cartwright & Co.
24, LONDON ROAD, MANCHESTER.

Phone—Central 4200. Grams—Pladuram, Manchester.
 Works—BERRY STREET.

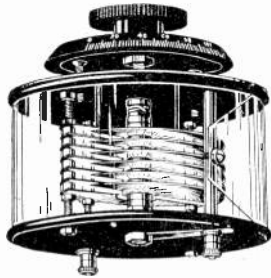

As our special offer of PHONES is now closed, we are offering **CONDENSERS** (complete and parts) at considerably reduced prices

Get our lists—3d. post free.

Our Standard Prices for Phones are now :

140 ohms	30/-
4,000 "	32/-
8,000 "	33/-

SPECIAL TERMS TO THE TRADE.

Sole distributing Agents for Scotland—
J. GORSTON SINCLAIR & CO., 47, Waterloo Street, Glasgow.
 Retail Agents for Blackburn—
THOS. BARTON & CO., The Electric Works, Blackburn.

ZODEL CONDENSERS

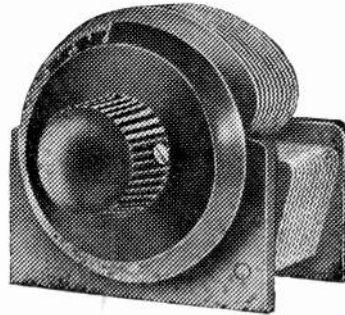

THE LAST WORD IN PRECISION.

The Zodel Condenser embodies new ideas. Specially designed plates, mounted eccentrically. Gives an open scale at lower readings. Low body capacity—no rubbing contacts—therefore silent. Made to engineers' fine limits. Machine engraved ebonite dial. Supplied in all capacities—skeleton type—or boxed to order.

'0008 - 17/6 ; '0002 - 15/- ; Vernier - 10/6
 YOU CAN RELY ON ZODEL GOODS. Full Price List post free

WALLACE HEATON, Ltd., RADIO EXPERTS
 84, HIGH STREET, SHEFFIELD.

Laboratories and Factories :
King's Rd., St. Pancras, LONDON.

ANODE All communications to Reg. Offices :
265, STRAND, W.C.2
 Tele. Nos. : City 4887, Cen. 3722

WIRELESS AND SCIENTIFIC INSTRUMENTS LTD.
Members of the British Broadcasting Company

ANODE POPULAR SETS.

These Sets Receive Two Bands of Wavelengths—
 350-600 metres (for British Broadcasting)
 2,000-3,600 metres (for Paris Time Signals and
 Concerts, also NAUEN.

POPULAR CRYSTAL SET ... £4 11 6

(7½" × 5½" × 2½" with Renewable Crystals).
 Patent Condenser Tuning.

POPULAR SINGLE VALVE SET... 7 10 0

(9" × 6" × 3" with Fixed Reaction).
 Patent Condenser Tuning

ANODE VARIOMETER SETS.

Employing our New Type of Patent Variometer 350-
 3600 metres continuous.

CRYSTAL SET ... 6 7 6

(7½" × 5½" × 5½" with Renewable Crystals).

SINGLE VALVE ... 8 19 6

(9" × 6" × 5½" with Fixed Reaction).

The above Receiving Sets all conform to the
 Postmaster-General's latest Regulations.

Variometer "C" (simplified model)

150-600 metres	1 5 0
Fitted with coupling coil	1 17 6

ANODE PATENT VARIOMETERS (New Type)

Improved pattern employing Two Lattice Wound Coils
 only, so keeping both Resistance and Self-capacity low

Model 'A' 350-3,600 metres ... £3 18 6

„ 'B' 2,500-25,000 metres ... 3 18 6

„ 'A' or 'B' fitted with Vari-
 able Reaction Coil ... 4 15 0

The above Variometers are complete in Cases.

Also supplied for Panel Mounting. Same price
 Manufacturers to Post Office design of Receiving Sets now in
 operation at "Leafeld" "Cairo" "Northolt" etc.

NOW is the Time to Order.

**Your Final Choice. Why Not Your First?
 Trade Enquiries Invited.**

EXPERIENCE

BROAD

HIGH POW All Bear Bro

Made under
High Frequency Am-

*All these models
seen in our*

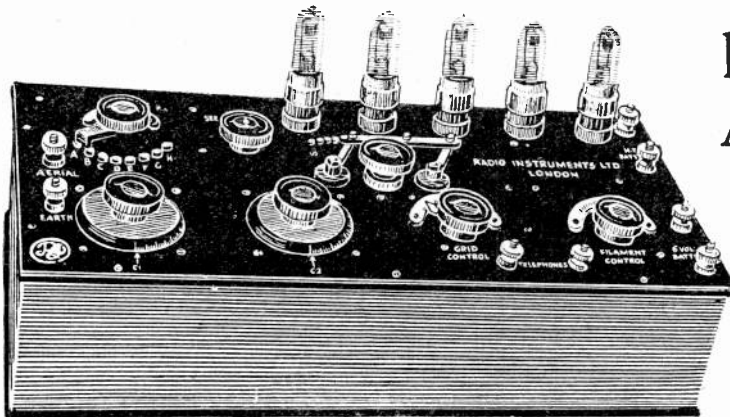

5-VALVE SET.
Price £40.
Price without
accessories, £32.
P.O. Registered
No. 1108.

Descriptive brochure con-
taining full particulars sent
on application.

DELIVERY

The most experienced
Radio designers of High
Power Receivers in the
World.

*Special Brochure dealing
sent on*

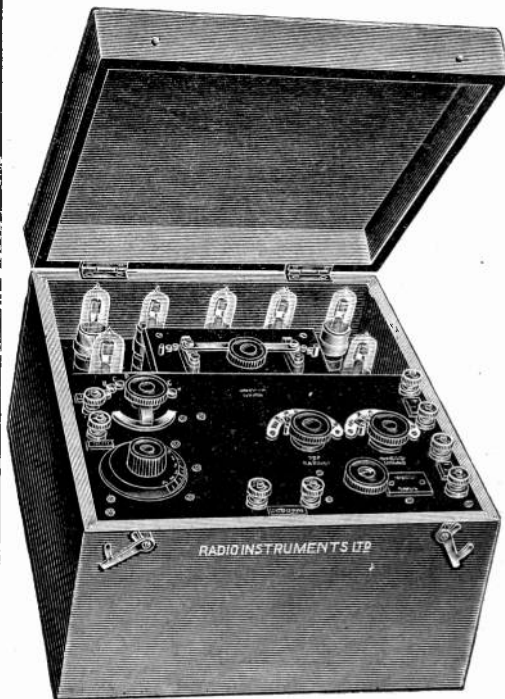

7-VALVE SET.
Price, complete
with all acces-
sories .. £75
Price of Instru-
ment alone, £66
Valves Extra.
P.O. Registered
No. 0140

RADIO INSTRU

Managing
J. Joseph, M.I.E.E., late Manager
Chief
W. A. Appleton, M.B.E., M.I.R.E., late
Research

ONLY ADDRESS: Works,
12a, Hyde Street, NEW OX
Telephone—Regent 1908.

CASTING

ER MODELS adcasting Seal

Marconi Licence.
plication on all Sets.

and others can be
Showrooms.

For the facilities of customers we have arranged for our showrooms to remain open, during the month of December only, until 7 p.m. on weekdays, and until 6 p.m. on Saturdays.

FROM STOCK

All our Broadcasting
Models,
300-4000 metres.

with Cabinet Sets
application.

MENTS LTD.

Director :
to Mr. H. W. Sullivan,
Designer :
Admiralty Technical
Officer.

Offices and Showrooms :

FORD ST., W.C.1

Telegs—Instradio, London.

2-VALVE SET.
Price, complete,
£23 15s. Valve
Amplifying Re-
ceiver alone,
without Acces-
sories, £18 5s.
P.O. Registered
No. 2003.

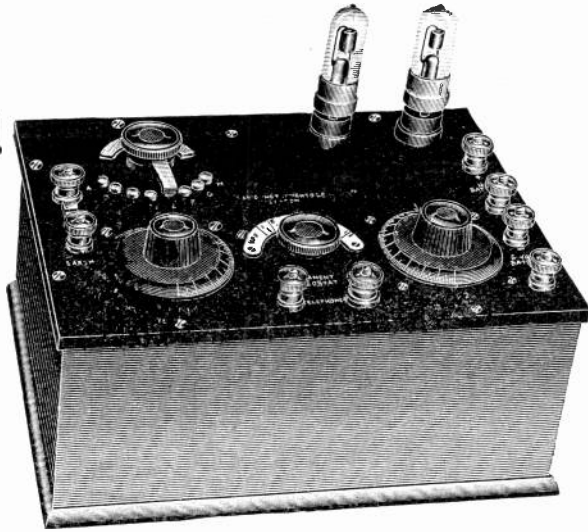

3-VALVE SET.
Price £30 15s. Valve Amplifying Receiver alone, without Accessories, £23 15s. P.O. Registered No. 0109.



4-VALVE SET.
Price £33 10s. Valve Amplifying Receiver alone, without Accessories, £27 5s. P.O. Registered No. 0112.

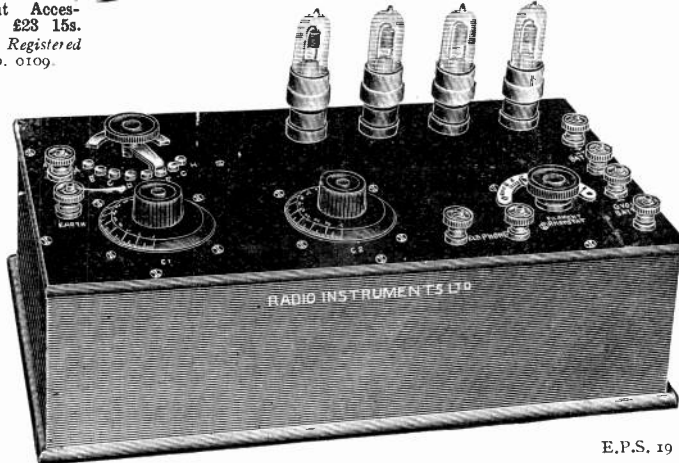

It Speaks for itself—

and in no uncertain voice

THE WORLD'S STANDARD LOUD SPEAKER

AMPLION

WIRELESS
LOUD
SOUNDING
RECEIVERS
are supplied
in a series of
Ten Models
Suitable for
every service:
**The Home,
Laboratory**
and the
Concert Hall



At Prices
ranging from
£2:10:0
to
£15:15:0

—Daily—
Demonstrations
at the
**GRAHAM
SHOWROOMS**
The
**ALGRAPHONE
SALON**
25-26 Savile Row
Regent St., W.1

"MUSIC MASTER" HORN

Type AR 13, 120 ohms **£6:0:0**
Type AR 15, 2,000 ohms **£6:2:6**

"Graham" Wireless
Productions include
"High Efficiency"
Telephone Headsets
of improved design
and construction.
The "Graham" is
the best Head Gear
money can buy.

Full particulars for-
warded upon request.
Ask for Folder W.

Patentees and Manufacturers:

**ALFRED GRAHAM
AND COMPANY**
St. Andrew's Works, Crofton Park
LONDON - - - S.E. 4

SCOTLAND:

Mr. F. M. Milligan,
25, Renfrew Street,
GLASGOW.

IRELAND:

Mr. Alex. R. Munday,
41, Chichester Street
BELFAST.

WILTON WIRELESS

REMEMBER THE NAME — IT STANDS FOR QUALITY

- Aerial Wire, 100' 3/6
- Aerial Wire, 150' 5/-
- Lead-In Tubes 1/6
- Insulators 6d., 9d., 1/-
- Fixed Condenser 1/9
- Valve Holders 1/-
- Filament Rheostats 3/-
- Ivoryine Scales 8d.
- Switch Arms 1/6
- Ex-Govern. " R " Valves .. 14/-
- Engraved Dial, 2 knobs with fixing Screw 2/6
- Sleeving per yard 4d
- Detectors 3/6

2-VALVE SUPER REGENERATING SET OF PARTS.

Everything Ready including Loop Aerial .. **£10**

BROADCAST RECEIVER, SINGLE VALVE.

Supplied with 3 Plug-in Coils for Broadcast Croydon, Paris. Ideal for Telephony.

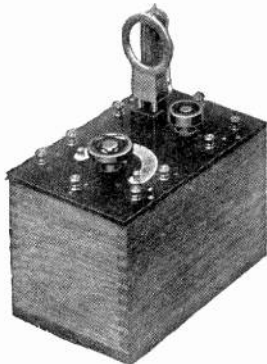

TESTED BEFORE DESPATCH

50/-

Set of Parts 35/-

Some New and Special Bargains

3 Coil Holders, Standard Type **10/6**

Plug and Fixing Bands 2/-

DUO BASKET COILS — for maximum efficiency on short waves—these fit Honeycomb Plugs—

400-700m., 3/-; 500-900, 3/6; 600-1,000, 4/-; 800-1,400, 4/6; 1,000-2,800, 5/-; 2,000-5,000 m. 5/6.

" **SUPREME** " — Wireless Head-phones, aluminium, light and comfortable, 4,000 ohm, 25/-; 8,000 ohm, 27/6.

" **SUPREME** " NOTE MAGNIFIERS —for attaching to any existing set. Crystal or valve.

Enormously Magnifies Speech—Music.

45/-

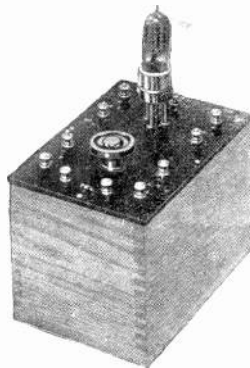

FULL SET OF PARTS .. 35/-

Our Technical Bureau at Your Disposal—Write Your Query—Simple or Complicated—Our Expert Can Help You.

L.F. TRANSFORMERS.
Correct impedance for Telephony 17/6
(Diagram with each.)

H.F. PIN TRANSFORMERS.
400m. 1,700m. 900m. 1,100m.
3/6 4/- 4/6 5/-

TUNED ANODE TYPE.
Fitted Swivelling Resistance—
400m. 1,700m. 900m. 1,100m.
5/6 6/6 7/6 8/6
(Diagram with each.)

VARIABLE CONDENSER in cast aluminium.

FRAMES NEVER WARP.

·0003 ·0005 ·0008 ·001
17/6 8/6 9/6 12/6

Cabinet Type, 5/- extra.

" **SUPREME** " CRYSTAL RECEIVER

Fitted Hertsite Crystal. Wound for Telephony.

Neat and Efficient. Every one tested before despatch **30/-**

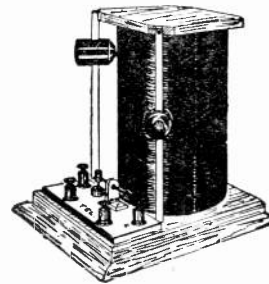

YOU MUST HAVE OUR LIST

Send your name for one at once.

SETS OF PARTS FOR AMATEUR OR MANUFACTURER. TRADE SUPPLIED

THE WILTON WIRELESS COMPANY

120/124, HIGH STREET, TOOTING, S.W.17

TELEPHONE No. STREATHAM 533

THE WIRELESS WORLD EXCHANGE AND MART

TARIFF. Advertisements are accepted for this Section at the rate of twopence per word, with a minimum charge of two shillings. The advertiser's name and address will be charged for, and single letters and single figures will be counted as words. Compound words will be counted as two words.

DEPOSITS. All advertisements must be prepaid in the form of Postal Orders, the remittance being forwarded to Messrs. Bertram Day & Co., Ltd., 9 & 10, Charing Cross, S.W.1.

Intending purchasers may deposit the purchase money of any article advertised or sold by advertisers with Messrs. Bertram Day & Co., Ltd., who will acknowledge its receipt to the vendor and the depositor, the full addresses of whom should be given. Subject to special agreement between the parties, it is understood that all goods are sent on approval, each party paying carriage one way in the event of the goods being returned. The deposit will be retained until due advice of the completion of the purchase has been given or until the articles have been retained and accepted. In order to cover postage, etc., a fee of 6d. in respect of sums of £1 and under, and 1s. for sums in excess of £1, must be paid at the same time as the deposit. For persons not resident in the United Kingdom these fees are doubled. We cannot undertake to receive any deposit less than 2s. 6d.

FOR SALE

B.A. Screws, Nuts and Washers, assorted gross 2s. lists 2d.—J. H. BENNETT, Station Road, Willesden Junction.

Wireless Masts.—Improved Girder Type, light and strong, 30 to 50 ft. at 1s. ft., 50 to 100 ft. at 1s. 6d. ft. Cash with order, carriage forward.—F. ARMSTRONG, Weybridge.

Agate Cylinders, etc., for loud speaking apparatus from JAMES R. GREGORY & Co., Mineralogists, 139, Fulham Road, S.W.

Five Wireless Sets Given Away. Particulars 3d.—HINKS, Wireless Dept., Hardington, Yeovil.

All Wireless and Electrical Goods stocked at 9, Colonial Avenue, Minories, near Aldgate Station. Handiest place for City buyers.—LESLIE DIXON & Co., Telephone No. Avenue 4166.

R. Valves, 10/- each. £5 per dozen. B. Valves 12s. each, £6 per dozen. All new and tested. Post free. Ebonite Variometer Rotor, 5s. each. B. CALVER, 52, Linver Road, London, S.W.6.

Magnavox, as New, £8 8s. Two-valve amplifier, £4. Tingey "A2" Unit, 50s. Two "A" coils, 30s.—CLARK, Spilsby Road, Boston, Lincs.

High Frequency Unit, four transformers, £2.—SHAW, 8, Hall Road, Trawden, Colne.

Burnt Three-valve Receiving Set, £15.—GOSHERON, 71, Herne Hill, S.E.

Brown's "A" Type Telephones, 120w. ex-Government, 12s. 6d. pair. C. Mk. III three-valve amplifier L.F., £3 10s. Post free.—PICKERSGILL, Hudswell, Richmond, Yorks.

Dewar Switches, 2s. each. Any number of ways. Postage 3d.—DICKERSON, 10, Albert Road, Brockley, S.E.4.

Loud Speaker, ready to connect to your set. First 30s. secures.—BARTLETT, Milford-on-Sea, Hants.

Two-Valve Telephones and C.W. Transmitter, by Gambrell. Complete with control panel and microphone. As new, £5.—HEALEY, Perranperth, Cornwall.

Recording Relay, 10,000 ohms, as new, £6 or offer. Morse inker, 30s., bargain. Agate cylinder, finest obtainable for loud speaker construction, 30s.—B. PARSONS, 42, Draycote Place, S.W.3.

Single Valve Panel, 18s. 6d. Variable condensers for panel, 0-001, £1 2s. 6d.; 0-0005, 18s. 6d.—RUTHERFORD, 21, The Crescent, Whitley Bay.

"L.B." Morse Senders. 120 more at 6s. each, post free. Sends any message any speed from 2 to 80 words per minute. Will last a lifetime, and is specially recommended for amateurs requiring home practice. Further particulars halpenny stamped envelope.—GRIMSHAW'S (Dept. W.), Legh Street, Golborne, Lancs.

WANTED TO PURCHASE. Burnt Out Valves Bought, 3d. each.—123, Walthew Lane, Platt Bridge, Wigan.

TRADE ENQUIRIES. Wholesale Wireless Supply Co. requires quotation from manufacturers of parts and sets, must be rock bottom.—R.E. Co., LTD., 4, Little Titchfield Street, W.1.

Wireless Dealers throughout Great Britain are strongly advised to stock parts for making up wireless sets. Buy your parts direct from the factory at wholesale prices.—NEWTONIA WIRELESS FACTORY, 13 and 15, Whitcomb Street, W.C.2.

AGENTS WANTED. Old-established London Firm, making one to five-valve broadcast receivers, desires provincial agents. Every assistance and good terms offered.—Box 76, c/o F. ALDRIDGE, 26, Paternoster Row, E.C.4.

SITUATIONS VACANT. A Good Opportunity is offered to a few enthusiastic wireless amateurs of entering the employment of a well-known firm, as installers and demonstrators of wireless transmitting and receiving sets. Must have good working knowledge of valve sets, erection of aerials, etc., and must be able to explain and educate a customer in the use of his set. Knowledge of Morse essential up to ten words per minute. Ex-ship operators need not apply.—Box X.2, BERTRAM DAY'S ADVERTISING OFFICES, 9 and 10, Charing Cross, S.W.1.

ELECTRADIX WIRES

Highest Conductivity at Lowest Prices.

Gauge.	D.C.C.	S.S.C.	D.S.C.
16	1 7	—	3 6
18	1 9½	—	3 9
20	1 11	4 0	4 6
22	2 5	4 6	5 0
24	3 0	5 0	5 9
26	3 6	5 6	6 6
28	4 2	5 9	6 10
30	5 2	6 6	8 1½
32	6 6½	8 2	9 0
34	7 9	9 6	10 7
36	9 2	11 3	12 3½
38	11 10	13 6	17 3
40	16 2½	17 0	23 5

Prices at per lb. Postage Extra. Earth Clips 6d. each. 7/22 Aerial Wire, 7/- per 100 ft. 3d. extra for reeling off small quantities and spool.

EVERYTHING FOR WIRELESS IN STOCK.
LESLIE DIXON & CO.,
9, Colonial Avenue, Minories, E.1
(near Aldgate Station.) Telephone Avenue 4166.

HOW TO MAKE YOUR OWN WIRELESS RECEIVING SET.

Amplifiers and Detectors. No marking out. Full-size Diagrams and all wiring details accurately given; success guaranteed. In two Series, 2/6 each. Publisher, T. Appleby, 109, High Street, Boston, Lincs.; or London Agents: Messrs. W. & G. Foyle, Ltd., 121, Charing Cross Road, London, W.C.2. and Economic Electric, Ltd., 10, Fitzroy Square, London, W.1.

HEATH & Co., Ltd.

Instrument Works, New Eltham, S.E.9 are prepared to undertake in their fully equipped works—Wireless Apparatus and Parts for the trade. Quotations given to Blue Prints. Immediate attention. Phone—Lee Green 301. Wire—Polaris, London.

Cheapest house in the Trade for



Wireless Supplies AND Equipment (Wholesale only)

33 D'Arblay Street SOHO, W.1 ASK FOR OUR LIST

To the Trade

CONNOLLY'S (Blackley) LTD.
Blackley, Manchester.
ENAMELLED WIRES for MAGNETS and AERIALS
London Office: 18, Victoria St., S.W.1
Tel. Vic 6368. Telegrams: Lifehold, Vic

NOTE THESE PRICES !!
Wavelength 150 to 4,500 Metres.

EXCELLENT FOR TELEPHONY.
Per set of 7, 5/- Post 3d.

CONDENSERS. COMPLETE SETS OF PARTS

Approx. capacity Microf'ds.	No. of Plates.	Price
001	58	7/6
00075	43	6/9
0005	30	5/6
0003	19	4/6
0002	13	3/6
0001	7	3/-

Postage 1/- per set extra.

Will make up as illustrated

FILAMENT RESISTANCES .. each 4/-
A.E.G. VALVES, TESTED .. " 7/6
MARCONI " D " TYPE .. " 10/-

Postage Extra.

ALL AMATEUR WIRELESS SUNDRIES IN STOCK.
ILLUSTRATED CATALOGUE IN COURSE OF PREPARATION.

Grafton Electric Company
Showrooms—54, GRAFTON STREET, TOTTENHAM COURT ROAD, LONDON, W.1. Telephone—Museum 241.
Works—Slough.

THE WIRELESS WORLD EXCHANGE AND MART

Your Case Work

Let us quote you for your wireless casework. We are specialists in this class of work and feel sure our workmanship and prices will interest you.

Phone—L.W. 2720.

CARRINGTON & NEWBERY LTD.,
18/20, Normans Buildings, Old Street, E.C.

ESTABLISHED TWENTY-FIVE YEARS.

J.W.B. ACCUMULATORS

RESULT OF OVER 40 YEARS' EXPERIENCE.

4v. 40a. .. 18/- 6v. 40a. .. 26/-
4v. 60a. .. 21/- 6v. 60a. .. 31/-

PLATES, SETS, BOXES, SEPARATORS, REPLACEMENTS, EXPERT REPAIRS.

J. W. BARNARD

WORKS: 45, GT. ORMOND STREET, LONDON, W.C.1, and 4, GT. WINCHESTER STREET, LONDON, E.C.2

FREE

Booklet on Wireless Telegraphy and Telephony, not a catalogue, clear simple and concise with diagrams. Write using halfpenny stamped p.c., giving name and address only, nothing else to

STANDARD ENG. TOOLS CO.,
25, LAURENCE POUNTNEY LANE, E.C.1

WIRELESS CABINETS

PROMPT DELIVERIES
COMPETITIVE PRICES

PICKETT BROS.,

Albion Rd., BEXLEYHEATH, S.E.

Reliable Radio Supplies

L.F. Intervolve Transformers, 15/-, 17/6.
H.F. Pin Type Transformers, 3/6, 4/6, 5/6.
4,000 ohm Headphones, 19/6, 25/-.
Enclosed Crystal Detectors, 4/9.
Three-Coil Holders, standard type, 10/6.
Honeycomb Coils, 1/3, 1/9, 2/-, 2/6.
Filament Resistances, 3/-.
Terminals, 1/6, 2/-, 2/6 doz.

SETS OF PARTS. DIAGRAMS FREE.

New List being prepared.

AMATEUR SUPPLIES,

134, Coteford St., Tooting, S.W.17

SITUATIONS WANTED.

Wireless Expert, five years' experience, First Class P.M.G. (three systems) wishes leave sea for suitable position ashore. Manchester or district preferred.—A.I. c/o BLAKELEY HEATON MOOR, Post Office, Stockport.

Advertiser—Knowledge wireless and some capital, is open to consider sound business proposition, mutual interest.—Box C.8. BERTRAM DAY'S ADVERTISING OFFICES, 9 and 10, Charing Cross, S.W.1.

Naval Wireless Telegraphist. Superior abilities, six years' experience practical and theoretical, all systems transmission and reception. Requires any position connected with wireless.—Write Box K.5, BERTRAM DAY'S ADVERTISING OFFICES, 9 and 10, Charing Cross, S.W.1.

Advertiser, with eleven years' experience of telephones and electrical accessories, designing, testing, assembling, etc., seeks position. Good future prospects regarded of more importance than amount of immediate salary.—Box Z.4, BERTRAM DAY'S ADVERTISING OFFICES, 9 and 10, Charing Cross, S.W.1.

MISCELLANEOUS.

Now, Wireless Societies and Amateurs. We specialise in manufacture of any apparatus to your or our specification. Get above the crowd with your aerial or adveys with our balloon and V aerials (patents applied for). Our installation service at your disposal. All makes broadcasting receivers supplied.—RESIDENTIAL WIRELESS, Kenyon Street, Blackley, Manchester, 'phone Cheetham 56, Grams. "Resiradio" Manchester.

East Ham, Wanstead, Ilford, Manor Park and Forest Gate. Amateurs should not fail to come to the RADIOFENDEZVOT'S, 709, Manor Park, Broadway (over Liptons's). Club open till 10 p.m. nightly.

If you require a full experimental receiving and transmitting licence you must satisfy the G.P.O. that you have a sufficient knowledge of W.T. science to warrant the issue of such a licence.—THE LONDON TELEGRAPH TRAINING COLLEGE, LTD., will give you the necessary qualifications in 12 lessons. Write for full particulars of evening lectures to Secretary (Dept. A.T.) 262, Earl's Court Road, S.W.5.

BOOKS.

Radio Magazines, all the latest, "Radio World," 10d.; "Popular Radio," 10d.; "Radio Broadcast," 1s. 6d.; "Radio News," 1s. 6d.; "Science and Invention," 1s. 9d.; "Scientific American," 2s. 6d. Post free.—INTERNATIONAL NEWS COMPANY, LTD., 15, Bream's Buildings, London, E.C.4.

FOR SECURING YOUR AERIALS and a Thousand Purposes where Great Strength and Strain is needed ::

FLEXIBLE STEEL WIRE ROPE.

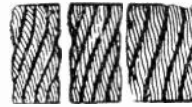

Aeroplane Cable made to Govt. specification to specified breaking strains. Orders of 10/- and over carriage paid, otherwise please add 1/- for postage.

PRICES BELOW COST.

No.	Dia.	Breaking Strain.	Price per 100 ft.
3	1/8"	20 cwt.	8/-
51	5/32"	25 cwt.	10/-
53	7/32"	45 cwt.	12/-
5	1/4"	70 cwt.	14/-
6	9/32"	80 cwt.	15/-
7	11/32"	100 cwt.	20/-
8	1/2"	120 cwt.	21/-
9	13/32"	140 cwt.	22/6
10	7/16"	160 cwt.	24/-

STRAINERS for use with above, right and left hand threads, 9d. each, or 8/6 per doz.

SMITH & ELLIS
(Dept 6) 11, LITTLE BRITAIN, ALDERSGATE STREET, E.C.1

GEOPHONE RECEIVING SETS APPROVED BY THE POSTMASTER-GENERAL FOR THE RECEPTION OF ALL BROADCASTING.

No. 1 Crystal Set. Range 25 miles, £5 10s.
No. 2 Crystal Set. Range 30 miles, £9 15s. complete with buzzer combined for fine adjustment of crystal. The above sets complete with aerial and all accessories.

Two-Valve Set Complete in mahogany cabinet with mahogany case for 'phones, and teak case with straps for accumulator. Range 100 miles, £25.

All the above sets are manufactured and guaranteed by The General Electric Co., Ltd. Write for Illustrated Lists.

WIRELESS SUPPLY,
21, GEORGE STREET, HULL.

Wireless Apparatus

and parts designed and manufactured at our fully equipped works. High class work and finish.

MOORES & GRIFFITHS, LTD.,
BEXLEYHEATH, KENT.

'Phone, Bexleyheath, 114. Wire: Scopes Bexleyheath.
Manufacturers of "Broadwave" Receiving Set, P.O. Regd. No. 168.

THE MORSOPHONE (Protected) FOR TEACHING MORSE.

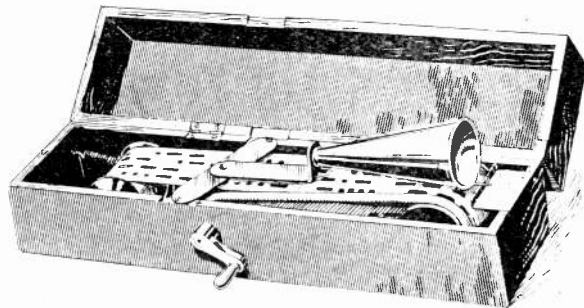

Listen In on the Morsophone. Alphabet and Figures. Perfectly time Morse at any speed by turning a handle. Learning a pleasure. 25/- carriage paid.
I. BOULTON, OXLEY BANK, WOLVERHAMPTON.

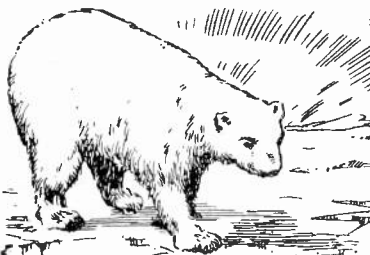

66 POLAR 99

NO EQUAL BETWEEN THE POLES.

Per mare per terram

BRIEF DETAILS OF THE

NEW "POLAR" VARIABLE CONDENSER

1. The Capacity Range is from '0001 to '001 mfd.
2. The size is 3" x 3½" x 1".
3. The Guarantee is for 12 months.
4. The Price is 14/- (arranged for panel mounting).
5. The Makers are the

RADIO COMMUNICATION CO. LTD

of 34/35, Norfolk Street, Strand, LONDON, W.C.2,

Suppliers of the North Foreland (GNF) and Seaforth (GNV) Transmitting Stations for the Post Office, of coast stations for Colonial Governments, and of Ship's Radio for most of the great Shipping Companies.

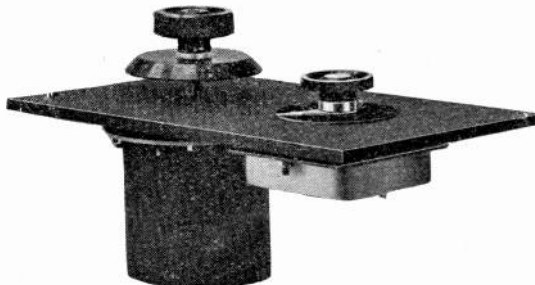

The Illustration from an actual Photograph compares the space occupied by a "Polar" Variable Condenser, and a 29 plate Ebonite Dielectric Multi-vane Condenser of the same capacity.

The Price Comparison is even more striking.

"POLAR" RADIOPHONES

embody all requirements from Crystal to Seven-Valve Receivers employing both High and Low Frequency Amplification. FOR LONG RANGE RECEPTION there is nothing to equal "Polar" H.F. Amplification. FOR ELIMINATION OF INTERFERENCE nothing so selective as the "Polar" Double Circuit Tuner. Catalogues on application.

Every Accessory stocked including the celebrated "MAGNAVOX" LOUD SPEAKER, which is specifically designed to eliminate distortion. Price £10, 10, 0

Write or Call at our Head Office (as above) or visit any of our depots at :

Liverpool : 67, Dale St. Cardiff : Atlas Chbrs., James St. Glasgow : 10, Blythwood Sq.
Newcastle-on-Tyne : 17, Sandhill. Southampton : 19, Queen's Terrace

NO EQUAL BETWEEN THE POLES.

WIRELESS SERVICE, LTD.

2, Lower John Street, Piccadilly Circus, W.

Visit our Showrooms without obligation.

Demonstrations daily on any set desired, at 2, Lower John Street, Piccadilly Circus (Near the Regent Palace Hotel).

IN OUR SHOWROOMS selections may be made from a complete range of the products of all the leading British Manufacturers.

Highest quality complete sets of all types. From £2 to £100.

Every set tested by our experts and guaranteed.

Save yourself all worry and trouble by subscribing to our Wireless Service. For a small annual payment we maintain your set in perfect working order.

Manufacturers are invited to send us details of their complete receiving and transmitting apparatus.

Expert advice free.

'Phone Regent 785 and ask us all about it.

"The Model Engineer"

A special paper for young Engineers, Apprentices, Students and Amateurs interested in Mechanics, Electricity and Model Making. It contains practical articles by experienced writers on Electrical and Mechanical subjects, Locomotives, Motor Cycling, Model Aeroplanes and Wireless Telegraphy. Published every Thursday. 5d. post free.

"Junior Mechanics & Electricity"

The paper for beginners of all ages in Mechanics, Electricity and Model Making. All the articles are written in simple language so that everybody can read and understand them. It is well illustrated. There is also a Queries and Replies section, from which much valuable information can be obtained. Published on 1st of each month. 4d. post free.

SOME USEFUL BOOKS.

Practical Lessons in Metal Turning .. 2/9	Small Accumulators .. 10d
Engineering Mathematics Simply Explained .. 2/3	Electric Bells & Alarms 10d
Practical Dynamo and Motor Construction 1/9	Electric Batteries .. 10d
Practical Induction Coil Construction .. 1/9	Small Dynamos and Motors .. 10d
Petrol Motors Simply Explained .. 1/9	Induction Coils for Amateurs .. 10d
Workshop Wrinkles and Recipes .. 1/9	Small Electric Motors 10d
	Alternating Currents 10d
	Windmills and Wind Motors .. 10d
	Wireless Telegraphy Simply Explained .. 10d

Every Boy's Book of Electricity, 3d.

Every Boy's Book of Engines, 3d.

Book List sent post free on receipt of card.
PERCIVAL MARSHALL & CO.,
 66m, FARRINGDON ST., LONDON, E.C.

WITH GOOD APPARATUS YOU CAN GET GOOD RESULTS

THE "W.P."

Morse Practice Key

Well Made. First-class Finish. Thoroughly Reliable.

Price 7/6 Post Free

THE WIRELESS PRESS, LTD.
 12-13, Henrietta Street, London, W.C.2

Questions and Answers COUPON

To accompany Questions sent in during the week commencing Dec. 2nd, 1922.

VOL. XI, NO. 9.

See Conditions on Page 315.

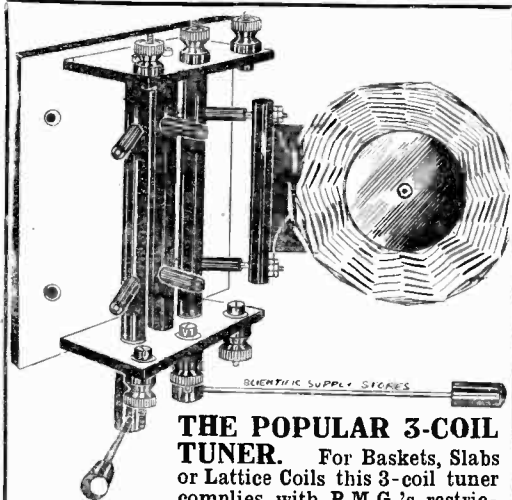

THE POPULAR 3-COIL TUNER.

For Baskets, Slabs or Lattice Coils this 3-coil tuner complies with P.M.G.'s restriction combining the highest efficiency with cheapness and practicability. With a set of Baskets this makes the most perfect Telephony tuning unit from 150-4,000 metres on the market. Tuning Stand with 3 coil holders, 12/6, post 9d. extra. Coil Holders, 1/3 each. Tuning Stand with 7 coil holders and set of Baskets, 21/6, post 1/-.

Scientific Supply Stores,
8, Newington Causeway, London, S.E.1
Phone—Hob 4177.

Dry Batteries for Wireless Sets

No. 1 W. Standard Pocket-lamp size, 4½ volts (as illustration), with patent spiral wire terminals for connecting in series. Insert straight terminal in spiral of next battery and bend same, no soldering required.

PRICE 7/- Per doz.
NOTE.—(1 doz. = 54 volts).

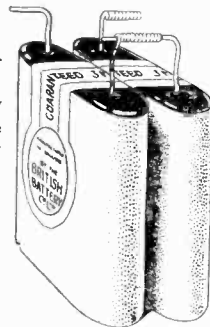

No. 2 W. Slab.
15 volts (11 cells), 3 screw terminals, size 9" x 7/8" x 2 3/4" high.

PRICE 3/- EACH

No. 4 W. Rectangular.
36 volts, 1 screw terminal and 8 plug holes with wander plug. Size 6 1/2" x 2 1/2" x 2 1/2".

PRICE 7/- EACH

No. 1 W.
Connect as illustration. (Patent applied for).

BRITISH MADE—CARRIAGE PAID.

Manufactured by—
THE BRITISH BATTERY Co., Ltd.
Clarendon Rd., WATFORD, HERTS.
(Telephone : Watford 617.)

WIRELESS

Component Parts for Wireless a Speciality
:: :: Complete Cabinet Crystal Sets :: ::
:: :: Build Your Set by Degrees :: ::
All Suitable Tools and Materials in Stock
:: Complete Folding Work Benches ::

RICHARD MELHUISSH LTD.
Tool, Machine & Hardware Merchants, Electrical Engineers
50, 51 & 84, Fetter Lane, E.C.4

Telephone : 1611 (3 lines) Holborn. Established 1828. Telegrams : "Workfolk, London."
Awards for Excellence of Tools and Machines :
Bronze Medal 1884. Gold Medal 1890.

Insulation for Wireless Apparatus

Before deciding on the form of insulation you will use may we draw your attention to

BAKELITE INSULATING MATERIALS.
(Trade Mark "FORMITE")

"Bakelite" resists temperature and climatic changes and is unaffected by water, moisture, sea air, acids and solvents. It is the only material that will withstand the extreme conditions to which wireless apparatus is likely to be subjected.

For further Particulars apply to

The Damard Lacquer Company Ltd.,
Warwick Road, Greet, Birmingham.

NORTH - EASTERN SCHOOLS OF WIRELESS TELEGRAPHY

Established 1911.

18, Eldon Square, Newcastle-on-Tyne
6, Blenheim Terrace, Leeds
33, High Street, Southampton

Young men between the ages of 16 and 25 are trained at these Schools in the profession of Wireless Telegraphy and Telephony. All Four Systems are taught, Marconi, Telefunken, Poulsen and Valve. Special terms to partly trained students.

Splendid Openings for Trained Wireless Men.

Write or call for Illustrated Prospectus.

WIRELESS



G. TURNOCK, 41 High St. Aston, Bham

To manufacturers and merchants—

Let us quote you for
SMALL SHEET METAL GOODS

also

CAPSTAN PARTS

:: Accuracy and ::
Finish Guaranteed

TREVENA & GLOVER

Cornwall Works, Price St., Birmingham.

Tel: CENTRAL 3697.

High-class Small Metal Goods Manufacturers.

ELECTRADIX RADIOS

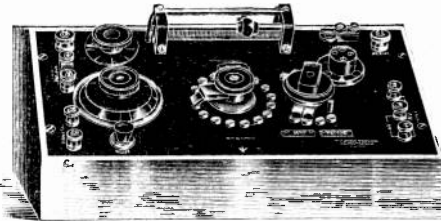

RECEIVING SETS. 50 D.C. Trench, sloping panel, crystal and valve. Ex Marconi; as illustrated, with H.R. 'phones. - - - **£7 15s.**

TWO-VALVE MK. II, with three-coil holder, variable condenser, complete with 'phones, less valves and batteries - - - **£8 0 0**

Both sets tested on our aerial and ready for use. Three-valve Amplifiers. **£5 10s.** Battery boxes, 4/-, 5/- and 7/-.



LARGE PURCHASE OF TELEPHONES NOW OFFERED AT REDUCED PRICES. Single L.R. Receivers, 4-head Sets L.R., with double head-band and cord, 8/6. Sullivan sets, ditto, with plug and jack, 14/-. 1,500 ohm headsets and cords, 17/6. 2,000 ohm, 19/6. Marconi Sterling, from 49/-. Sullivan single receivers for rewinding, 2/6 each. 'Phone transformers, 14/- each.

THIS WEEK'S BARGAIN. Broadcast Aerial Outfit. 100' 7/32 copper aerial, 8 R.A.F. insulators, lightning arrester on ebonite base, P.O. type. Download, 35/40's rubber-covered 12 yards aerial to set, 10/- post free.

VARIABLE CONDENSERS. .002 Table-moulded ebonite case, very fine, 38/-. Murdochs in all sizes, table and panel.

WESTON RELAYS. For recorders and micro-amplifiers, 40/- each, new.

H.T. DYNAMOS, 500 volts, **£18.** Six volts, **£4 10s.** Send us your enquiries as we have a huge stock of instruments of various types and all wireless sundries.

Call at our Showrooms in the City. We are near Aldgate Station, Metropolitan Railway, and buses pass the door. First Avenue on the left in Minories.

LESLIE DIXON & CO.
9 Colonial Avenue, Minories, E.1.

W. J. HENDERSON

351, FULHAM ROAD,
SOUTH KENSINGTON.

(Bus Routes Nos. 14 and 96 pass the door.)
(Nearest Stations, Earl's Court and South Kensington.)

ACCESSORIES OF QUALITY

Aerial Wire, 7/22 enamelled copper, per 100'	5/-
Aerial Insulators, brown porcelain	each 9d
Aerial Stay Wire, 15 cwt. breaking strain, steel flexible cable (sample on request), per 100'	5/-
Aerial Mast Strainers (turnbuckles)	each 8d., per doz. 7/6
Coilholders, for three coils, for panel mounting, complete with terminals	each 14/6
Coilholders, Igranic, table stand, complete with extension handles and patent spring terminals	each 21/-
Coils, Igranic, duolateral	from 5/-
Condensers, fixed, .0003 and .0005	each 1/6
Condensers, fixed, Dubilier	each 2/6 and 3/-
Condensers, Variable, for panel mounting, complete with knob and pointer, Vernier, 5/-; .0003, 12/-; .0006, 15/-; .001, 20/-	10/-
Ducon special "electric-light aerial" attachment, each	5/-
Filament Rheostats, for panel mounting, one valve	6/-
Three-valve	5/-
Grid Leak and Condenser, Dubilier	3/-
High Tension Batteries, 15-volt blocks, with flexible leads, long life	each 5d.
Insulated Sleeving, Red, Green, Brown, Yellow, per yard	1/-
Ivory Scales, semi-circular, engraved 0-180, best quality	each 12/6
Loud Speakers, Amplion, 120 ohms, £8; 4,000 ohms, £8 5s.	25/-
Potentiometers, circular type for panel mounting, complete with knob and pointer, 350 ohms	20/-
Reactances Coils (Radio Instruments), short wave, 20/-; all waves	22/6
Transformers (Radio Instruments), Intervolve	25/-
Telephone	20/-
Transformers (Igranic), Intervolve	22/6
Transformers, High Frequency, to fit valve holders -	
300m.	5/-
400m.	5/6
600 m.	6/-
1,000m.	6/6
etc., etc.	
Telephones, double headgear, 4,000 ohms, Ericsson, complete with cords, extremely sensitive, per pair	33/-
Valveholders, mounted in ebonite, fitted with washers and nuts	each 1/-
Valves, M.O. "R" Type	each 17/6
Valves, Ora	each 15/-

The above are only a few selected items from our large stocks.

Terms, Cash with order; goods above £2 in value carriage paid.

Post Orders are despatched on day of receipt.

Lists on request.

SIEMENS DRY BATTERIES



TWO UNSOLICITED LETTERS.

An Appreciation—

67, Broad Street,
Hanley, Stoke-on-Trent.
8th November, 1922.

Dear Sirs,

On June 29th, 1920, I purchased a batch of 15-volt high-tension batteries from you and on receipt of same put six into use with my Wireless receiving station. Same have had heavy use since almost daily, and I feel it my duty to say that they have given every satisfaction and are still in commission. This I think amply demonstrates the superiority of your units as to efficiency, long life and economy in a component so important a factor to the amateur.

Sincerely yours,
A. H. WILSON.

A Recommendation—

Manor Road School,
Wallasey, Cheshire.
October 21st, 1922.

Dear Sirs,

I have been employing four of your 15-volt H.T. Units No. 643 for the last eighteen months in a two-valve circuit. They have been in constant daily use, but still give a reading of 52 volts, and are perfectly silent in action. In many cases, amateurs are too ready to blame atmospheric for noises which can easily be avoided by the use of good H.T. Batteries.

I shall always recommend your batteries for this purpose.

I am, Yours faithfully,
JOSEPH C. SHARP, B.Sc. (London).

WITH ACKNOWLEDGMENTS TO THESE TWO GENTLEMEN FOR THEIR COURTEOUS PERMISSION TO PUBLISH LETTERS OF INTEREST TO OTHER USERS OF DRY BATTERIES.

SIEMENS BROTHERS & Co. LTD.

General Offices & Works:

WOOLWICH, LONDON, S.E.18

Telegrams: SIEMENS, WOOLWICH. Telephone: CITY 6400 (7 lines).

And at
Belfast, Birmingham, Bristol, Cardiff, Glasgow,
Leeds, Manchester, Newcastle, Sheffield, Southampton.

ADVERTISING PAYS

If you use the right paper

The following extract is typical of letters being constantly received testifying to the wonderful advertising value of the

“WIRELESS WORLD”

“ 52, Linver Road, London, S.W.6

3rd Nov., 1922.

“ Although I have only had two small advertisements in the ‘Wireless World,’ they have more than proved the wonderful results of which your paper is capable. In my case it has been thousands of orders from 4/6 for Advertising.

“ You are quite at liberty to make use of this, should you so desire.

B. G. CALVER.

If you Advertise the right way

OUR claim to specialised knowledge in Wireless Advertising is based on Ten Years’ practical experience. This, together with our Complete Wireless Advertising Organization, is at the disposal of every *bona fide* Advertiser entirely free of charge. No business is too small or too large to command our prompt attention and courtesy.

Whatever your Advertising problem or difficulty, it will pay you to get in touch with us. Why buy your experience when expert advice is yours for the asking?

BERTRAM DAY & CO., LTD.

Organisers of the First All-British
Wireless Exhibition, 1922.
Wireless Publicity Specialists.
Contractors, Printers and Publishers.

Sole Advertising Agents for the “Wire-
less World.” Full particulars and rates
on application.

9 & 10, CHARING CROSS, S.W.1

Gerrard 8063, 8064 and 8065.

BRANCHES AT MANCHESTER AND GLASGOW.

32/- per Pair
- 4000 ohms.
Al. Resist.
ances in
stock.



---CQ Std bi for ERICSSON PHONES

WHEN you install your wireless set—crystal or valve—you'll get maximum results if you fit Ericsson Phones—clarity, sensitivity, strength of signal and absence of "click." Specially suited to telephony. Ericsson Phones embody the accumulated experience of telephone manufacture for a generation. Easy to the head, light and comfortable. The magnets never lose their strength and "shorts" are non-existent.

Write for Particulars

The BRITISH L. M. ERICSSON
MANUFACTURING Co., Ltd.
Head Office : 67/73, International
Buildings, Kingsway W.C.

Ericsson

TELEPHONES

"RADIO - WAVE" CONCERT RECEIVERS.

TWO-VALVE RECEIVER; BROADCAST RANGE 100 MILES.

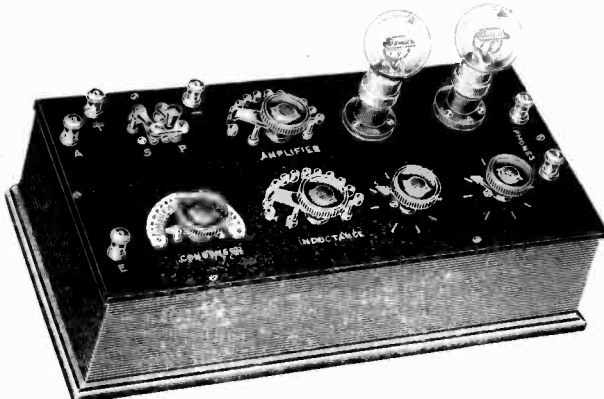

PRICE: £16 : 16 : 0 with Valves.

Approved by the P.M.G. for Broadcast Reception.

THE "Radio-Wave One-Valve Receiver (Price : £10 : 10 : 0) meets the needs of those living within 50 miles of a Broadcasting Station. For those living at greater distances there are the Radio-Wave 2, 3, 4 and 5 Valve Sets. These are described in our descriptive catalogue which contains over 40 illustrations of wireless apparatus actually made in our works, sent free.

THE MEDICAL SUPPLY ASSOCIATION, LTD.

167/185, Gray's Inn Road, London, W.C.2.

Works: LONDON & SHEFFIELD.

Telephone: MUSEUM 7212 Ext. 3.

Components

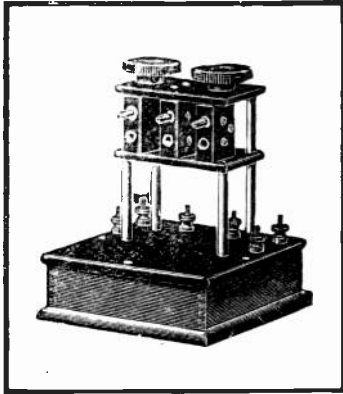

*Every Article
made by
Auckland's
is in a Class
by Itself.*

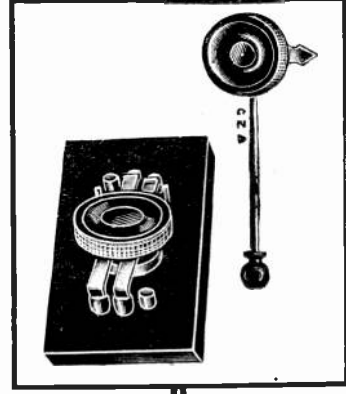

- Series Parallel Switches 4/6
- Table Coil Holder 3 way 18/-
- " " " 2 " 15/-
- Fil. Resistances 3/9
- Interval Transformers 20/-
- Igranic (Auckland)
Coils from 5/-

CATALOGUE FREE

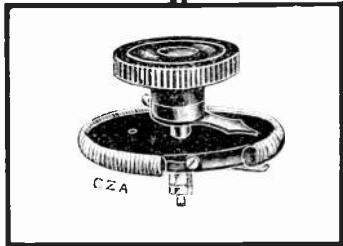

- Telephone Transformers 13/6
- " " Mtd. 17/6
- Extended Knobs and
Pointer 1/6
- Condenser Dials and
Knob 3/9
- Coil Plugs 1/6
- Fibre Strip 4' 6" 1/-
- Uni Wave Slabs—Set.. 12/6
- Grid Leak and Con-
denser 4/6
- Pin Type H.F. Trans-
former for Broadcast 5/-

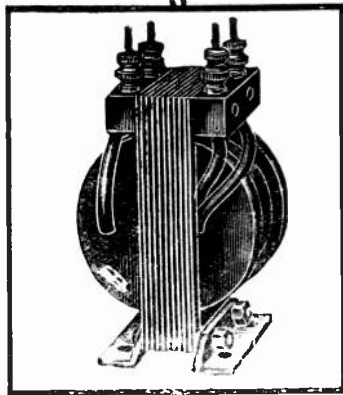
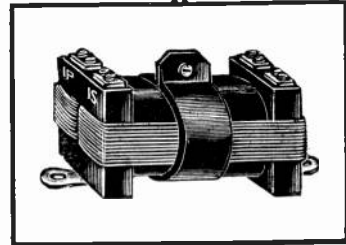

We carry stocks of all makes of H.T. Batteries, Phones and Valves, and supply from stock.

Why not make use of our World Wide Service? It will pay you, especially if you say

*“Auckland
Products”*

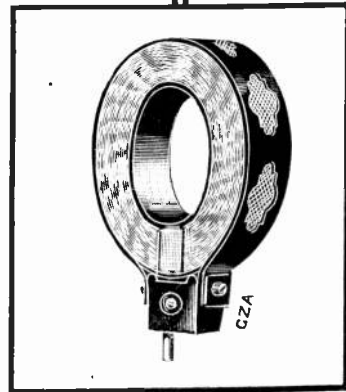

G. Z. AUCKLAND & SON,
Factories—ISLINGTON, N. WIRELESS INSTRUMENT MAKERS

LONDON OFFICES:
395, St. John Street, E.C.1
'Phone - - - 3173 CLERKENWELL

An Auction of Interest to Amateurs

Note the Date

WEDNESDAY
6th DEC., 1922
at 12.30 o'clock
:: precisely ::

On view: Monday, 4th Dec.,
from 12.30 to 5.30, **Tuesday**
from 9.30 to 5.30, and on
morning of Sale
from 9.30 till
:: 12 o'clock ::

INCLUDED in this important sale of **EX-GOVERNMENT WIRELESS APPARATUS** there will be a large number of **SMALL LOTS** eminently suited for purchase by Wireless Experimenters.

THE TRADE will also have an excellent opportunity of securing:—

NEW MARK III TUNERS, MARK III C.W. TRANSMITTERS and RECEIVERS, B. MARK II 2-VALVE DETECTOR AMPLIFIERS, 50 WATT SPARK TRENCH SETS for Receiving and Transmitting. **C. MARK III 3-VALVE AMPLIFIERS** (low frequency) in new condition. **BROWN'S HEAD TELEPHONES** Reed Type, 120 and 8,000 ohms in new condition. Valve Boxes, Teak Instrument Cases, a quantity of 13 ft. masts and a large quantity of **Miscellaneous WIRELESS GEAR.**

STEVEN'S AUCTION ROOMS, LTD.

(Established 1760)

will Sell the above by Auction at their Great Rooms,

38, KING STREET, COVENT GARDEN, W.C.2

Telephone—1824 GERRARD.

Catalogues free on application.

Telegrams—"Auks, Rand, London."

ROYAL CORPS OF SIGNALS, TERRITORIAL ARMY.

The 48th (South Midland) Divisional Signals, Birmingham.



THERE are a number of vacancies in the Wireless Sections of this Unit for men possessing an elementary knowledge of Wireless. The training includes instruction in Operating and Procedure and practical work with 30 and 120 watt C.W. Sets.

Friends joining together will be posted to the same section whenever possible.



For further particulars apply personally, or in writing, to the **Orderly Room, 48th Divisional Signals, T.A., Great Brook Street Barracks, Birmingham.**

The
Wireless World
DIRECTORY
 OF
Regular Transmissions
 OF
Wireless Stations.

PRICE **6^d** POST FREE.

Containing full particulars of over 350 of the Chief Stations of the World.

The Wireless Press Ltd.
 12/13 Henrietta St., London, W.C.2

The
Wireless World
POCKET DIRECTORY
 of
Amateur & Experimental
Transmitting Stations

Price **6^d** post free.

Giving particulars of 380 Amateur Transmitting Stations.

The Wireless Press, Ltd.
 12-13, Henrietta St., Strand, London, W.C.2

Design of
Modern Radio
Receiving Sets

Vol. I (The Brown Book)

Vol. II (The Blue Book)

By M. B. SLEEPER

Price **2/6** each

(Price 3d)

Showing the construction of instruments so simple that they can be assembled in the "kitchen table workshop," yet so designed that they give the appearance and results of commercial equipment.

The unique feature of these books is that every instrument described is first built and tested in the laboratories of the Sleeper Radio Corporation.

Other "Sleeper" Books are as follows :

Construction of Radiophone and Telegraph Receivers for Beginners.

Price 4/- net. Post Free, 4/3.

Construction of New Type Transatlantic Receiving Sets.

Price 4/- net. Post Free, 4/3

Radio Experimenters Handbook.

Price 5/- net. Post Free, 5/3

The Wireless Press, Ltd.
 12-13, Henrietta St., Strand, London, W.C.2

Perfect your Morse AT HOME

with the assistance of the

Marconi Official Gramophone Records

For Self-Tuition in receiving
Morse Signals.

Price per record - - - - 5/-
(Packing and postage 9d. extra.)

Set of Six 10-inch Double-sided Records 30/-
(Packing and postage free.)

SERIES I. Record 1. *One Side.*—The Morse Code, including full figures, abbreviated figures, and punctuation signs, as printed in the Postmaster-General's Handbook. *Reverse.*—Difficult letters which experience has shown give most difficulty to learners; also a sentence sent slowly.

Record 2. *One Side.*—A Press message sent at a speed of approximately 10 words per minute. *Reverse.*—A similar message at a speed of 50 per cent. faster.

Record 3. *Both Sides.*—Dummy messages, properly numbered, timed and counted, as exchanged between ships and stations, and *vice versa*.

Record 4. *One Side.*—Difficult business message, containing figures, fractions, Stock Exchange terms, etc.; one or two mistakes have been introduced and then corrected in the accepted style. *Reverse.*—Code words and cipher transmitted at a normal rate of 20 words per minute.

Record 5. *One Side.*—Various messages, such as would be met with in an ordinary day's transmission, sent at the rate of 25 words per minute. *Reverse.*—Messages in French, Spanish and Italian.

Record 6. *One Side.*—Signals from two distinct transmitters on different notes; Press message transmitted at 25 words per minute jammed by similar matter at slower speed. *Reverse.*—Mixed messages jammed by Press messages.

SERIES II. Record 1. *One Side.*—Morse Code, including full figures, abbreviated figures, and punctuation signs, as printed in the Postmaster-General's Handbook (Sounder Record). *Reverse.*—Simple Press, sent slowly (Sounder Record).

Record 2. *One Side.*—Italian Press, 25 words per minute. *Reverse.*—French Press, 25 words per minute.

Record 3. *One Side.*—Spanish Press, 25 words per minute. *Reverse.*—Portuguese Press, 25 words per minute.

Record 4. *One Side.*—Figures and fractions at moderate speed. *Reverse.*—Poldhu Press, with interruptions by voices, whistles, and various noises, to teach the reception of signals in conditions of difficulty from interruption.

Record 5. *One Side.*—"Distress Record" in which two ships working are interrupted by a third which sends the SOS signal. The traffic of the ship in distress is then expeditiously handled. This is a very dramatic record, exactly reproducing the wireless conditions at sea when a cry of distress is sent out. *Reverse.*—Ship and shore working with correct "T.R.s" and properly coded messages.

Record 6. *One Side.*—Messages from ship to shore at 25 words per minute, with jamming from French Press. *Reverse.*—Messages from shore to ship at 25 words per minute, jammed by similar Press.

The Wireless Press, Ltd.,
12-13, HENRIETTA ST., LONDON, W.C.2

NOW READY

BINDING CASES VOL. X.

The Wireless World & Radio Review

(INCLUDING INDEX)

Price **2/6** nett.

(Post free 2/11.)

INDEX (IF PURCHASED SEPARATELY)

Price **8d.** Post free.

A limited number only of COMPLETE BOUND VOL. X

(April—September, 1922)

Price **25/-** nett.

(Post free 26/-)

For the benefit of those of our readers who desire to have their parts bound, we shall be glad to undertake this for them upon receipt of the copies and remittance of 8/6 which includes cost of Binding Case, Index and return postage.

The WIRELESS PRESS Ltd.
12-13, Henrietta St., London, W.C.2



The FELLOCRYST

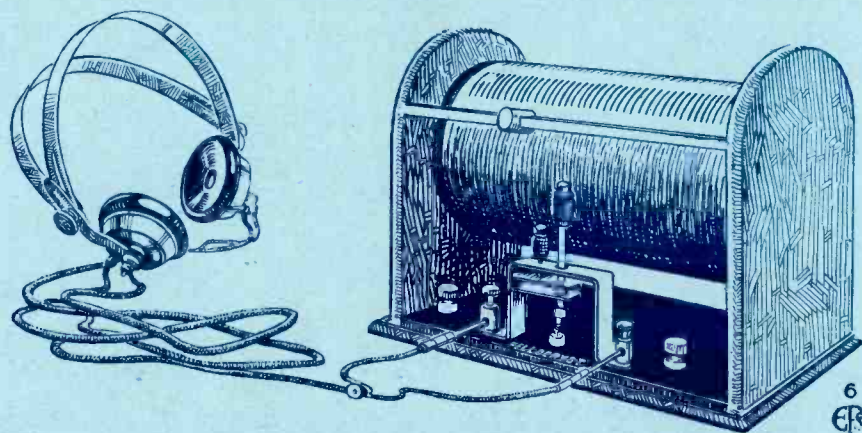

THIS is an excellent crystal receiving set, which gives very good results on all wavelengths from 300-1,500 metres, and is suitable for receiving broadcasting, ships and long distance stations.

The adjustments are simple and easily made, and the silicon crystal detector well maintains its sensitive state. No batteries are required.

The set is sent out complete and includes 100 ft. coil of 7/22 stranded copper aerial wire, 2 shell insulators and one pair 4,000 ohms double headphones.

Every set is tested and guaranteed to receive broadcasting up to 15 to 20 miles and Morse signals from a much greater distance.

The "FELLOCRYST" is British Made Throughout.

PRICE COMPLETE £3 : 7 : 6 Postage 1/6 extra.

Extra 4,000 ohms double headphones 30/- (Postage 1/-)

For they are jolly good Fellows

FELLOWS MAGNETO CO., LTD.,
LONDON, N.W.10

Telephone : Willesden 1560-1.

Telegrams : Quixmag, Phone, London.

H. W. SULLIVAN (LTD.)

FORMERLY H. W. SULLIVAN, FOUNDED IN 1900.

One of the oldest established manufacturers in this Country of Radio Telegraphy and Telephony apparatus ; the pioneer in the systematic design, construction and supply of Amateur Radio Sets and Components, and in furnishing users with practical electro-technical advice, *e.g. inter alia* the Sullivan Book of Working Diagrams of Valve Amplifying Receiver Circuits. 10,000 copies of this book, the first and most complete of its kind, have been issued to all parts of the World.

BROADCASTING

Improved Crystal Receiver.

(PATENTS APPLIED FOR)

Prices from £2 : 17 : 6
(Including Broadcasting Commission).

Combined Crystal and Valve Set.

Prices from £9 : 5 : 0
(Including Broadcasting Commission and Marconi Royalty).

Valve Receivers.

"Two-Valve"	- -	£14 15 0	Including Broad- casting Commission & Marconi Royalty
"Three-Valve"	- -	£19 0 0	
"Four-Valve"	- -	£23 15 0	

Valves for above 17s. 6d. each.

Further Particulars on Application. : Trade Enquiries are Invited.

New Book of 34 Valve Diagrams (4th Edition), Price 1/-, post free within the United Kingdom, the British Dominions and the Crown Colonies and Dependencies.

DEMONSTRATION AND SHOWROOMS : Liverpool House, Middlesex Street, E.1
Two minutes walk from Liverpool Street and Broad Street Stations. **TRADE TERMS ON APPLICATION.**

Works :
"LIVERPOOL HOUSE,"
MIDDLESEX ST., LONDON, E.1
Phone—Avenue 4871

H.W. Sullivan, Ltd.
Telegrams—"Deadbeat, Stock, London."

Offices :
WINCHESTER HOUSE,
LONDON, E.C.2, ENGLAND
Phone—London Wall 3518



Printed by Sanders Phillips & Co., Ltd., Chrissell Road, London, S.W.9, for the Proprietors and Publishers, The Wireless Press, Ltd., 12-13, Henrietta Street, London, W.C.2; Sydney, N.S.W., 97, Clarence Street; Melbourne, 422-24, Little Collins Street; New York, 326, Broadway.



WIRELESS WORLD

AND

RADIO REVIEW

No. 173. [No. 10.
VOL. XI.]

9th DECEMBER, 1922.

Registered at the G.P.O.
as a Weekly Newspaper.

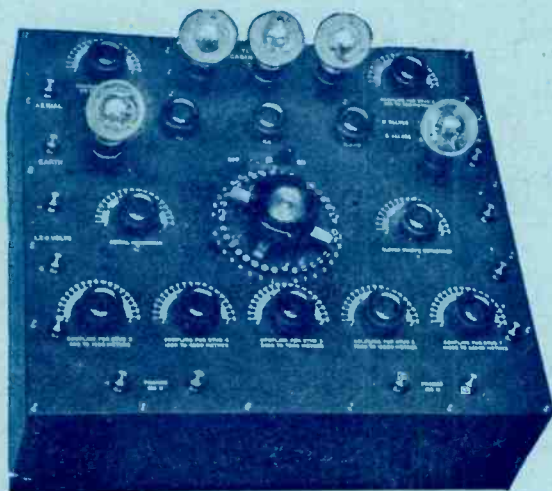

(REGISTERED DESIGN)

TINGEY UNIVERSAL RECEIVER

All "Tingey" Valve Apparatus is duly licensed under Marconi Patents for Amateur use in Great Britain.

All our "Broadcast" Receiving Sets are approved by the Post-Master General.

TINGEY WIRELESS LTD.

Offices & Showrooms: 92, QUEEN STREET, HAMMERSMITH, LONDON, W.6

Offices and Works—'Phone: HAMMERSMITH 1916.

Telegrams: "TINGOIDAR LONDON."



STERLING No. 1 CRYSTAL RECEIVING SET

Specially designed for use in connection with the Wireless Telephony Broadcasting Scheme, and is suitable for a range of about 25 miles.

PRICE £7-12-6

TO BE OBTAINED FROM ALL
DEALERS OR DIRECT FROM:—

**STERLING TELEPHONE
& ELECTRIC CO., LTD.**

210-212, Tottenham Court Road,
LONDON : : : W.1

Telephone No. : 4144 Museum (7 lines)

Telegrams : "Cucumis, Wesdo, London."

Works : DAGENHAM, ESSEX.

BRANCHES:

NEWCASTLE-ON-TYNE : 9, Clavering Place.

CARDIFF : 8, Park Place.

We guarantee that all Broadcast Radio Apparatus sold by us conforms with the conditions of the Broadcaster's Licence issued by the P.M.G.

IMMEDIATE DELIVERY

The YEAR BOOK of WIRELESS Telegraphy and Telephony 1922

1476 Pages.

Price 15/- Nett.

Demy 8vo.

Postage Inland 1/-.

Abroad 1/4.

CONTENTS:—

Record of the Development of Wireless Telegraphy—National and International Wireless Laws and Regulations—Directory of the World's Land and Ship Wireless Stations—International Allocation of Call Letters—Alphabetical List of Call Letters—Meteorological Section—International Time and Weather Signals—National Résumés of Progress in Wireless Telegraphy—Particulars of Wireless Telegraph Patents, 1921—Aviation Section—Tabular List of Aviation Stations—Useful Data Section—Wireless Terminology—Conventional Signs used in Wireless Diagrams—Companies Engaged in the Commercial Development of Wireless Telegraphy—Biographical Section—Literature on Wireless Telegraphy and Telephony—Directory of the World's Wireless Societies—Directory of Wireless Colleges and Schools—List of Licensed Amateur Transmitting Stations—Code Section—Special Articles on "The Earthing Resistance of Antennæ," by Dr. Miessner—"The Recording of Wireless Signals," by Dr. Abraham—"The Birth and History of Long Distance Wireless Telegraphy"—"The Rectification Effect in its Reaction to the Composition and Structure of Crystals."

A valuable feature of the present issue is the specially drawn map, which gives, for the first time, a simple means of finding the distance and true direction of Wireless Stations in all parts of the World, from London as the centre.

THE WIRELESS PRESS, LIMITED,

DEPT. W.W., 12-13 HENRIETTA
ST., STRAND, LONDON, W.C.2

GAMAGES

Important New Types of Condensers
For Every Wireless Purpose. London's Largest Range to Choose From.

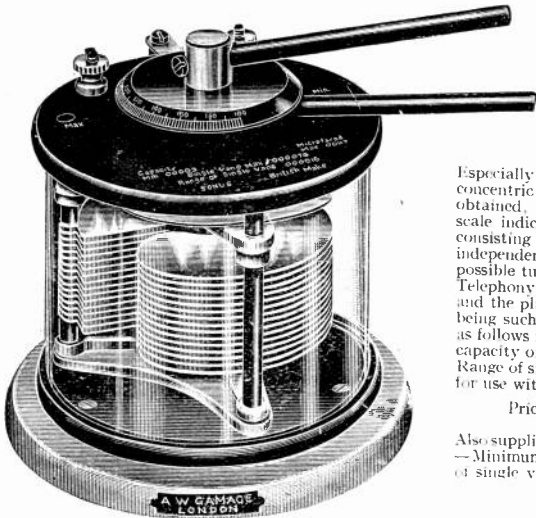

"SONUS" TYPE

We are now able to offer these new types of Variable Condensers, which have been designed to meet the demand of the Wireless experimenter for instruments of this pattern, and while no expense has been spared in perfecting these condensers for their respective purposes, the prices are the lowest possible consistent with high quality.

"SONUS" TYPE

(As illustrated)

Especially suitable for the serious experimenter. The plates are of concentric design so that a gradually increasing capacity curve is obtained, the increase of capacity being directly proportional to the scale indications. The much needed Vernier movement is provided, consisting of a single fixed and moving vane, which can be operated independently of the main condenser, thereby enabling the closest possible tuning to be obtained, which is invaluable for the reception of Telephony. The moving element works in specially designed bearings and the plates are clamped together at one side, the design throughout being such as to ensure great strength and efficiency. Capacity range as follows:—Minimum .00003 mfd. Maximum .00117 mfd. Maximum capacity of single vane with main condenser at minimum .000046 mfd. Range of single vane, .000016 mfd. This condenser is specially suitable for use with our honeycomb inductance coils.

Price 4 guineas

Post free.

Also supplied in larger capacity for special purposes as follows. Capacity:—Minimum .00006 mfd. Maximum .00221 mfd. Maximum capacity of single vane with condenser at minimum .000076 mfd.

Price 5 guineas

Air Dielectric Type

CAPACITY	DESCRIPTION	PRICE
No.		£ s. d.
No. 1 .0003 mfd.	Circular; ebonite top and bottom, encased in celluloid. Engraved ivory scale	1 5 0
(As Illustrated)		
No. 2 .00045 mfd.	Ditto	1 13 6
(As Illustrated.)		
No. 3 .0005 mfd.	Circular; ebonite top, bottom and case. Engraved ebonite scale	2 0 0
No. 4 .0006 mfd.	Circular; ebonite top and bottom, encased in celluloid. Engraved ivory scale	2 5 0
No. 5 .0007 mfd.	Square; ebonite top and bottom, encased in celluloid	2 10 0
(Illustrated below)		
No. 6 .0015 mfd.	Square; ebonite top, polished mahogany container. Engraved ebonite scale	1 19 6
(As Illustration)		
No. 7 .0015 mfd.	Square; sloping panel mahogany box	3 10 0

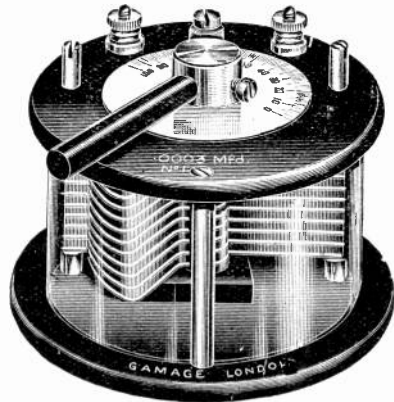

Nos. 1 & 2 Air Dielectric Type Variable Condenser (AS FARADAY HOUSE CALIBRATION)

This instrument is one of the neatest obtainable. It is of the best workmanship, electrically and mechanically perfect. It has 10 fixed and 9 moving vanes, and a maximum capacity of .0003 mfd. Top and bottom panels of matt ebonite with polished rounded edges. Fitted with engraved ivory scale, as shown. A handsome and efficient condenser.

Price No. 1 25/-
No. 2, .00045 mfd., 33/6

Special Laboratory Type

CAPACITY	DESCRIPTION	PRICE
No.		£ s. d.
No. 10 .002 mfd.	Air Dielectric, circular, in special metal case for screening the condenser.	7 17 6
No. 11 .003 mfd.	Ebonite top, engraved ebonite scale. Ditto	9 10 0

Write now for our WIRELESS CATALOGUE, Post Free on Request.

GAMAGES, HOLBORN, LONDON, E.C. 1.

At last!

THE PERFECT BATTERY FOR WIRELESS WORK

WE have specially designed for Wireless Work 3 types of Valve Batteries using the famous patent Block elements. These batteries have unique properties which make them far superior to the ordinary plate type — in fact exhaustive tests have proved that a Block accumulator gives TWICE the service on one charge compared with the ordinary plate type of the same rated capacity, and is thus *cheaper on first cost and cheaper in the long run.*

NO PLATES TO BUCKLE—DOES NOT READILY SULPHATE—NOT INJURED BY ACCIDENTAL SHORTING—WILL HOLD ITS CHARGE FOR MONTHS WHEN NOT IN USE.

6-VOLT VALVE BATTERIES

in ebonite containers with leather handles.

TYPE.	CAPACITY in Ampere hours.		PRICE.	
	Actual.	Intermittent.	£	s. d.
B.W. 6/10 -	10	20	1	5 0
B.W. 6/20 -	20	40	2	0 0
B.W. 6/30 -	30	60	2	12 6

WARNING.

When buying a Fuller Block Battery for Wireless insist on the **NEW MODEL WIRELESS TYPE** in **EBONITE** case, illustrated above.

There is going to be an enormous demand for these Batteries. Dealers who are not fully stocked should write us at once.

FULLER'S UNITED ELECTRIC WORKS, LTD.
WOODLAND WORKS, CHADWELL HEATH, ESSEX.

Telegrams: "Fuller, Chadwell Heath."

Telephone: Ilford 171 (4 lines) London
Phone Area.

BLOCK
ACCUMULATORS - SOLID - NO PLATES.
BATTERIES



100%
GREATER OUTPUT

Sold by Wireless Dealers, Electricians and over 200 Fuller Battery Service Agents throughout the Country. As used by Admiralty, Air Ministry, and War Office for Wireless Work.

Look for this name



Your guarantee of efficiency

The BURNDEPT Ultra IV Scores every time.

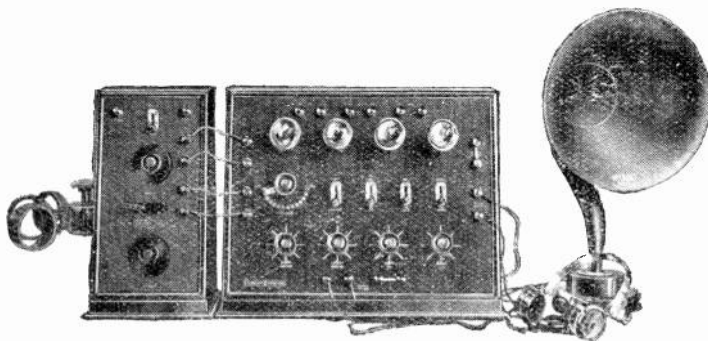

Astounding Results with an Ultra IV

London Broadcast Received on a **LOUD SPEAKER**
in **CHRISTIANIA** (Norway).

A satisfied customer writes to say that he, in Christiania, Norway, receives the B.B.C. Concerts regularly and easily on a Loud Speaker using only the amplification allowed for in this wonderful receiver.

We recommend this receiver to those of our Continental friends who desire to Listen-in to English Broadcasting. For long distance telegraphy reception this set is specially adaptable, and has received American Amateurs—Bandoeng (Java), Pearl Harbour (U.S.A.), etc. etc.

No. 104S. Ultra IV Receiver in polish walnut sloping case, £35A.

Write for our illustrated catalogue "U" giving much interesting information and details of our sets, price 1,-.

All **BURNDEPT** Valve Apparatus is duly licensed under Marconi Patents for Amateur use in Great Britain.

BURNDEPT, LTD., London Office & Showrooms: 15, Bedford Street, Strand,
Aerial and Electro Works, BLACKHEATH, S.E.3 W.C.2

Exchange Buildings, 133, New Street,
BIRMINGHAM.

236, Argyle Street,
GLASGOW.

London Assurance House,
Bond Place, LEEDS.

61, Bridge Street,
MANCHESTER.

Bank Buildings, Middle Street, YEOVIL.

BURNDEPT

WIRELESS APPARATUS

ACCESSORIES FOR PRIVATE WIRELESS INSTALLATIONS



SWITCH.

SWITCHES for series-parallel switching of condensers, adding to or reducing the number of valves in simultaneous use, etc.

VACUUM PROTECTORS (for protecting the aerial). They secure protection against risk of fire or damage by lightning. Will operate many times before renewal is necessary.

FUSES for protecting the filament accumulators and batteries in the event of a short circuit.

TELEPHONE HEAD SETS specially designed for wireless work. Terminals enclosed to prevent receiving circuit being interfered with.

**AERIAL WIRES & INSULATORS,
EARTHING DEVICES, JACKS &
PLUGS, H.T. BATTERIES,
etc. etc.**

ALSO MANUFACTURERS OF
BROADCASTING WIRELESS RECEIVING SETS

Descriptive pamphlet and prices on application to
THE MANUFACTURERS:

SIEMENS BROTHERS & CO., LTD.

General Offices and Works:

WOOLWICH, LONDON, S.E. 18

Telegrams—Siemens, Woolwich Telephone—City 6400.

And at Belfast, Birmingham, Bristol, Cardiff, Glasgow,
Leeds, Manchester, Newcastle, Sheffield, Southampton.

THE SAXON COIL HOLDER

Registration applied for.

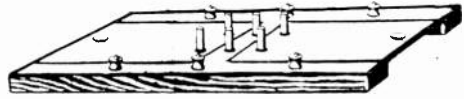

The cheapest and most efficient coil holder obtainable. Coils are quickly attached and removed and finest adjustment obtained by simply moving the sliding panels. Highly polished hardwood with terminals, connections, and wiring complete.

Three-Coil Holder, complete 10/-
Two-Coil Holder, complete 7/6

Trade and agency terms on application.

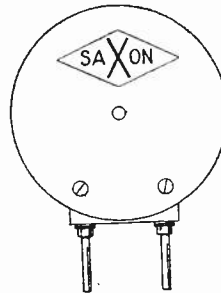

SAXON COILS

For use with the SAXON coil holder. The standard set of eight coils covers a wavelength range from 300 to 28,000 metres, with a .001 condenser.

Approximate range in metres.		Approximate range in metres.	
No. 1, 300 to 550 ..	3/-	No. 5, 2,500 to 6,000 ..	8/-
No. 2, 500 to 900 ..	3/6	No. 6, 5,000 to 11,000 ..	7/-
No. 3, 800 to 1,500 ..	4/-	No. 7, 10,000 to 20,000 ..	8/-
No. 4, 1,200 to 2,800 ..	5/-	No. 8, 15,000 to 28,000 ..	9/6

The set of eight, complete, 42/-.

BEGINNER'S GUIDE TO WIRELESS

Explains in plain everyday language everything beginners wish to know about wireless telegraphy.

HOW TO ERECT, CONNECT AND MAKE

All the apparatus required for reception of telephony and Morse, with full instructions and diagrams for making coils, tuners, valve and crystal sets, complete.

112 Pages. 1/- post free, on approval.

A copy sent free with orders value 10/-.

TRADE TERMS ON APPLICATION.

SAXON RADIO CO.

Manufacturers of Wireless Apparatus,

**HENRY STREET WORKS,
SOUTH SHORE, BLACKPOOL.**

32 page Catalogue of wireless components, 3d. post free.
Carriage paid terms: Orders under 10/- in value, 6d.
extra. Orders 10/- upward, carriage paid.

Doing away with the aerial

THE "DUCON"

Where there is electric light, an aerial is unnecessary. Plug a "Ducon" into an ordinary lamp holder or wall socket, connect to the wireless receiver and you will receive the broadcasting perfectly.

The set is quiet, there is no noise from the mains, and the "Ducon" is perfectly safe to use, consumes no current and does not affect the electric light in any way.

The "Ducon" gives satisfactory results with all types of receivers, from crystal to multi-valve.

The DUCON 10%

is obtainable from all leading wireless dealers, electrical contractors and stores, or direct from the makers.

Dealers not yet stocking are invited to write for trade terms.

Over 50,000 in use.

THE DUBILIER CONDENSER CO. (1921) LTD.,

Ducon Works, Goldhawk Road, Shepherd's Bush, London, W.12.

Telephone—Hammersmith 1084. Telegrams—"Hivoltcon, Phone, London."

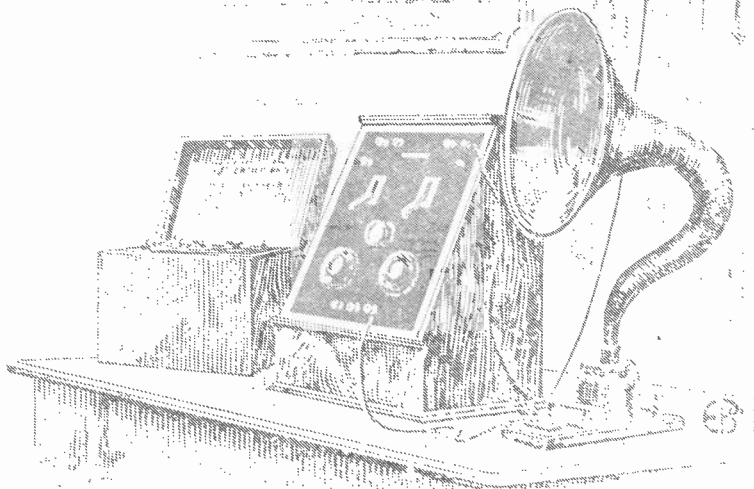
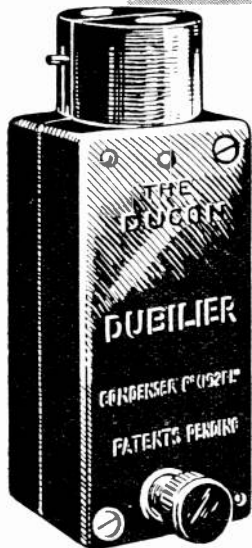

ADDITIONAL DISTRIBUTING
AGENTS REQUIRED
 FOR THE REMARKABLY EFFICIENT
"BROADCO" SETS

THE BROADCO CRYSTAL SET complete (receiver, phone, aerial and insulators) ready for installing:

70/- RETAIL

Range for concerts 15/30 miles. Conforms to P.M.G. Regulations.

VALVE SETS at prices ranging from
£3 10s. to 100 Gns.

VALVE PANELS, TUNERS, AMPLIFIERS, PHONES AND ERECTIONS.

EVERY SET GUARANTEED to be in PERFECT working order.

500 only single earphones 2000 ohms 12/6

Send for Descriptive Catalogue and Terms

The Broadcast Wireless Co., Ltd., 2, Tower Royal, Cannon Street, E.C.4.

Phones : City 8482, Putney 2572.

Telegrams : Adorners, London.

"THE BEST YOU CAN GET, IS THE BROADCO SET"



No. W.19

Ever-Ready
British Made

**DRY CELLS
 and BATTERIES**
 for High & Low Tension

THE STANDARD OF QUALITY



U.W.1

HIGH TENSION BATTERIES

Any size or voltage with any tappings or sockets at 3 or 6 volt intervals for use with Wander Plugs can be supplied to order
 With 13 sockets as illustrated.

No. W.19, 36 volts, 24 cells, 8/6 each. Size 6½ × 2½ × 3½.
 Weight 2 lb. 8 oss.

Wander Plugs 1/- per pair. With 2 Spring Contacts.
 No. W.11, 15 volts, 11 cells, 3/6 each. Size 9½ × ½ × 2½.
 Weight 1 lb. 2 oss.

THE UNIT DRY CELL

"Build up your batteries as you build up your Marconi Sets."

Unlimited flexibility in size, voltage and intermediate tappings. Each cell is fitted with brass screw terminal and looped wire, and they are efficiently insulated to prevent current leak.

No. U.W. 1, 7/6 per dozen. E.M.F. 1½ volts.
 Weight 3½ oss. Dimensions 2½ × 1 5/16 diam.

Art Catalogue of Standard Sizes and Voltages and list of Accumulators for Valve Filament Supply sent on request. Dept. D.L.

THE EVER-READY WORKS, Hercules Place, Holloway, N. 7.

EXPERIENCE

Important Announcement.

DEPOTS for the sale of Radio Instruments, Ltd., products have been opened in various parts of the country, and all their well-known instruments and components can now be purchased, wholesale or retail, on the same terms as would be obtained by placing your orders direct.

The Names and Addresses of the Depots are given below :

London : Harrods, Ltd.

Manchester (Sole Concessionaires for the North of England) :
Northern Radio Co., 30, Arcade Chambers,
St. Mary's Gate, Manchester.

Birmingham (Sole Concessionaires for the Midland Counties) :
Electrical Trades Supply, Ltd., Gt. Charles Street,
Birmingham.

Sheffield and District : Wilkins & Jackson, Ltd., 22, High St.,
Sheffield.

Aberdeen and North of Scotland : Lawson, Turnbull & Co., Ltd.,
8 to 18, Mealmarket Street, Aberdeen.

Swansea and District : Dan Morgan, 218, Oxford Street, Swansea.

Cambridge : Baily, Grundy & Barrett, Ltd., 2, St. Mary's
Passage, Cambridge.

Liverpool : Lewis's, Ltd., Ranelagh Street, Liverpool.

Reading and District : Reading Radio Supplies, 32, Castle Street,
Reading.

Oxford : F. E. Wootten, Ltd., 56, High Street, Oxford.

Glasgow : Rex Import Co., Ltd., Rex House, 202, Bath Street,
Glasgow.
Archibald Low & Sons, Ltd., 28a, Renfield Street,
Glasgow.

Rochdale (and Branches) : Dean & Holt, 78, Yorkshire Street,
Rochdale.

Further depots are being opened and the name and address of our nearest agent will be sent upon receipt of post card.

Every Wireless dealer should stock R.I. Products which now hold the premier place in the Wireless Industry for Efficiency and Reliability.

Dealers are advised to write for our latest showcard which is the most attractive Radio Poster yet issued.

RADIO INSTRUMENTS LIMITED

Managing Director : J. Joseph, M.I.E.E., late Manager to Mr. H. W. Sullivan. Chief Designer : W. A. Appleton, M.B.E., M.I.R.E.,
late Admiralty Technical Research Officer.

ONLY ADDRESS.
Works, Offices and Showrooms:
Telephone : Regent 1908.

12, Hyde Street, NEW OXFORD ST., W.C.1

Telegrams : Instradio, London.

**1/6**

NET

(Postage 2d.)

MAST AND AERIAL CONSTRUCTION for AMATEURS

By F. J. AINSLEY, A.M.I.C.E.

88 pages. Over 70 photos and diagrams.

This book is one which the amateur will read with gratitude to the author who has rendered a great service in removing the difficulties of mast and aerial construction.

With the use of a few ordinary tools and by following the instructions given in the book this will be found a simple matter.

1/6

NET

(Postage 2d.)

CRYSTAL RECEIVERS for BROADCAST RECEPTION

By PERCY W. HARRIS.

80 pages. Over 70 photos and diagrams.

An explanation in popular language of the principles upon which the numerous receiving Sets now on the market are designed, the reasons for the differences between them, and how all of them can be adjusted for the greatest efficiency.

Full Directions for building a simple Crystal Receiver for Wireless Telephone Broadcasting are also given.

4
MORE OF OUR
65 BOOKS

The Wireless Press, Ltd.
12-13 Henrietta St.
London,
W.C.2

Construction of Amateur Valve Stations

By ALAN L. M. DOUGLAS.

78 pages. 55 photographs and diagrams.

The aim of the author in compiling this volume has been to place within the reach of the amateur who is interested in wireless telegraphy and telephony a handbook which will enable him to obtain data that he has otherwise difficulty in acquiring, in order that he may construct for himself apparatus which he desires to make, but does not quite know how to design correctly.

1/6

NET.

(Postage 2d.)

The Radio Experimenter's Handbook

By PHILIP R. COURSEY, B.Sc.

113 Pages. 99 diagrams and illustrations.

The aim of the true wireless experimenter should not be merely to purchase a complete installation or to build one up from a complete set of working drawings, but rather to design his set to meet his own requirements. The object of this handbook is to foster, if possible, such an attitude by indicating the chief features of such design work and the principles upon which it depends.

3/6

NET.

(Postage 6d.)

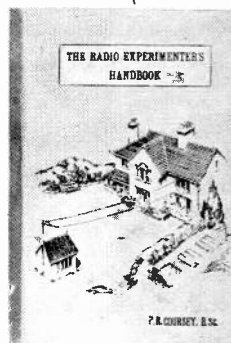

DIRECTION AND POSITION FINDING BY WIRELESS

Price
9/-
Nett

By R. KEEN
B.Eng. (Hons.) Sheffield, A.M.I.E.E.
Demy 8vo. 363 Pages
Over 250 Photographs and Diagrams

Post
9/9
Free

This book deals not only with the principles of the subject but with the constructional details of Direction Finding Installations.

It describes the principles of Direction and Position Finding in this country in such a way that the subject may be grasped easily by engineers tackling this field of wireless work for the first time.

CONTENTS.

The Theory of the Wireless Direction Finder ; Valve Amplifiers and Detectors ;
Maps ; Position Finding ; Night Effect and other Freak Phenomena ;
The Shore D.F. Station ; The Ship D.F. Station ; The Aircraft
D.F. Station ; Fault Clearing and Maintenance ; Notes
on Field and Nautical Astronomy ; Bibliography.

The Wireless Press, Ltd.
12-13, Henrietta Street,
London, W.C.2

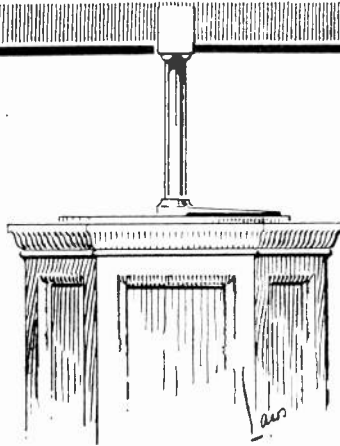



BROWN'S

Featherweight

HEADPHONES

British and Best

The Finest Headphones Procurable for

30/-

This price is for one pair of either 120 or 4000 ohm 'phones, including cords of good quality.

Catalogue Post Free.

TYPE F. "Featherweight."
Actual weight, including cords,
is 6ozs. only.

Head Office and
Works:
Victoria Road,
North Acton, W.3

S. G. BROWN, Ltd.

London
Showrooms:
19 Mortimer St.,
London, W.1

RADIO INSULATION

AS SPECIFIED AND USED BY THE BRITISH ADMIRALTY

BRITISH MADE

PAXOLIN

BRITISH MADE

TUBES DISCS PLATES, &c.

MANUFACTURED IN ALL FORMS, SIZES AND THICKNESSES

BY

THE MICANITE & INSULATORS Co. LTD.

EMPIRE WORKS

WALTHAMSTOW

LONDON, E.17

TELEGRAMS — "MYTILITE, PHONE, LONDON."

TELEPHONES — WALTHAMSTOW 738, 739



Oyez! Oyez!! Oyez!!!

**LISTEN-IN
to Broadcasting**

with complete receiving apparatus supplied by

WIRELESS SERVICE LIMITED

As our name implies we give real Service. A COMPLETE ORGANISATION OF EXPERTS who DEMONSTRATE, ERECT AERIALS, INSTAL and MAINTAIN Wireless Apparatus. Choose your set from a selection of

ALL THE BEST ON THE MARKET
and hear them demonstrated in **OUR SHOWROOMS**

Offices and Showrooms :-

WIRELESS SERVICE LIMITED

2, Lower John Street, Piccadilly Circus, W.1

Telephone—Regent 785.

(Just behind Regent Palace Hotel)

EBONITE

for all radio purposes

Highest Grades only made.

Sheets (polished, matt or tinfoil surface.)

Panels cut to size.

Rod, Tubing and all types of moulding for Wireless Instruments.

Take advantage of our long experience in Ebonite manufacture, and secure the best material for your purpose.

St. Helens Cable & Rubber Co., Ltd.

WARRINGTON

London Branch: 70/71, Petty France, Westminster, S.W.1

RADION

MAHOGANITE

This is the latest product of our Factories—a superior insulating material for high grade sets, which in grain and colour closely resembles mahogany. Its high insulating and non-warping properties, combined with a beautiful finish, make it an ideal material for Panels.

The Trade are warned against imitations—ordinary mottled Ebonite is *NOT* RADION - MAHOGANITE. All genuine Sheets are stamped "RADION".

Enquiries from bona-fide Manufacturers and Wireless Dealers solicited.

AMERICAN HARD RUBBER COMPANY (Britain) LIMITED,
13a, Fore Street, London, E.C.2

TELEPHONE—12754 CENTRAL.

OUR GREAT CRYSTAL "HERTZITE"

PRICE 2/6 POST FREE

IS THE ONE YOU WANT FOR **BROADCASTING**

With our Patent Detector ... 5/9 post free.
"HERTZITE" and
"PERIKON" Detector 6/6 post free.

VALVES

"R.M.R."	12/6
"XTRAUDION"	15/-
"ORA"	15/-
"C.V.C."	15/-

RUSSELL AND SHAW,
38, Great James St., Bedford Row, W.C.1
From Holborn through Brownlow St. or Hand Ct.

GREAT BARGAIN OFFER

To Readers of the "Wireless World"
For a short time only
—while the stock lasts.

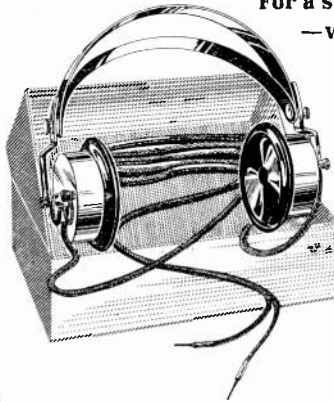

2,000 Pairs only
4,000 ohm
PHONES
(NEW)
at
17/6
PER PAIR.
Postage 9d. extra.

Fitted headbands and cords, beautifully finished, thoroughly efficient. Each pair carefully packed in box. Satisfaction guaranteed.

A wonderful bargain, never before offered and cannot be repeated. Readers of the "Wireless World" are urged to take advantage of this astonishing offer immediately. All orders will be executed in strict rotation.

Broadcasting Receiving Apparatus

The "JOYPHONE" (Reg. No. 0138) Approved type.
2-Valve Set complete ... from £12 : 0 : 0

TERMINALS.

4 B.A. Double Solid Brass or Plated, 2/- per doz. (post. extra)
2 B.A. Single " " " 9d. " " " "

Special Offer at Reduced Prices of our

NEW Intervalve Transformer

Owing to the unexpectedly large sale of these instruments, we are enabled to reduce the price to "Wireless World" readers to—

14/- postage 9d. extra.



Fitted with panel fixing plate and earthing wire for iron core. Fully tested. Ratio 5 : 1.

To obtain goods at these special bargain prices, please mention the "Wireless World"

We have ENORMOUS STOCKS OF EX-W.D. WIRELESS GEAR, too numerous to mention, at absurdly low prices. Write for particulars of your requirements or, better still, call and see our enormous stocks.

All valve apparatus manufactured by us is duly licensed under Marconi patents for amateur use in Gt. Britain. Approved by Postmaster-General.

J. LIPOWSKY & CO.
614, Old Ford Rd., Bow, London, E.3
Telephone—East 3345.
Near Old Ford Station, N.L.Ry. Nos. 8 or 39 Bus

AFA "DUROS" CELLS

The only accumulator supplied in a charged state. They retain their charge for very long periods.
Stocked by all leading dealers in "Wireless Supplies."

E. G. LIND & CO., 58a, BUCKINGHAM PALACE ROAD, WESTMINSTER, S.W.1

THE WIRELESS WORLD AND RADIO REVIEW

THE OFFICIAL ORGAN OF THE RADIO SOCIETY OF GREAT BRITAIN
A MAGAZINE DEVOTED TO WIRELESS TELEGRAPHY AND TELEPHONY

CONTENTS

The Spark Transmitting System of the Eiffel Tower. By E. M. Deloraine,	
Ing. E.P.C.I. - - - - -	321
A Design for a Coil Holder. By Allandale - - - - -	328
Electrons, Electric Waves and Wireless Telephony. By Dr. J. A. Fleming, F.R.S. -	331
History Repeats Itself - - - - -	337

NEWTON BROTHERS (DERBY) LTD.

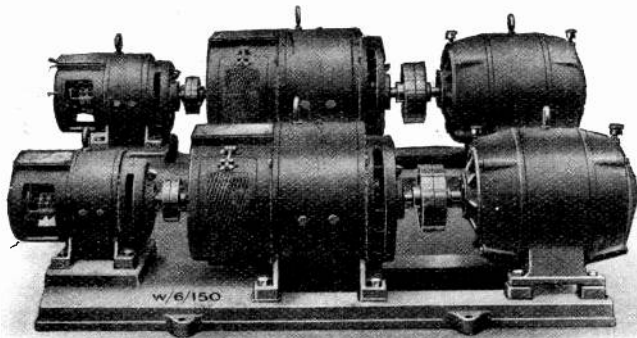

TWO 2½ Kw. **5000 VOLT** D.C. GENERATORS WITH 3-PHASE MOTORS, & EXCITERS.

Designed, Manufactured, and **SUPPLIED WITHIN TWO WEEKS** for
Manchester Broadcasting Station.

NEWTON BROTHERS (DERBY), LTD.
ELECTRICAL ENGINEERS,
DERBY.

MEN IN THE WIRELESS SERVICES DESIRING RAPID ADVANCEMENT

should train in spare time with the College which ensures this.
 "U.E.C." (Regent's Park, London, N.W.1) has in Twelve Years secured hundreds of successes by
 Individual Postal Training for Engineering Examinations and Professional Work.

State YOUR ambition in confidence, to—SECRETARY'S DEPT. (Desk W.),
 UNIVERSITY ENGINEERING COLLEGE, WESTGATE-ON-SEA, KENT,
 and expert advice with the New prospectus, No. 8, will be sent you without obligation.

CONTENTS (Continued)

Wireless Club Reports	338
A Selective Five-Valve Amplifier. By Maurice Child	343
Wireless Notes	346
Calendar of Current Events	347
Radio Society of Great Britain: Report of Proceedings	348
A Remarkable Achievement by British Radio Amateurs, By Philip R. Coursey, B.Sc., F.Inst.P., A.M.I.E.E.	350
Questions and Answers	352
Share Market Report	356

THE WIRELESS WORLD AND RADIO REVIEW is published weekly on Saturdays.

All correspondence relating to contributions should be addressed to THE EDITOR, THE WIRELESS WORLD AND RADIO REVIEW, 12-13, Henrietta Street, Strand, London, W.C.2.

No responsibility can be taken for MSS. or photographs sent without stamps to defray cost of return postage.

Editorial and Publishing Offices: 12-13, Henrietta Street, Strand, London, W.C.2.

Telegraphic Address: "Radionic, Rand, London." Telephone No.: Gerrard 2807.

Advertisement Managers, Bertram Day & Co., Ltd., 9 and 10, Charing Cross, S.W.1.
 Telephone No.: Gerrard 8063 and 8064

SUBSCRIPTION RATES.

28s. per annum, post free. Single Copies 6d., or post free 7d.

Registered at the G.P.O. for transmission by Magazine Post to Canada and Newfoundland.

HAMBLING CLAPP & CO WIRELESS SPECIALISTS

We are almost ready to supply receiving sets conforming in every way with the latest instructions of the Postmaster-General as related to Broadcasting.

Write u now concerning your particular requirements; no obligation will be incurred by your so doing.

There are no regulations to prevent the sale of our component parts, of which we supply a very large number. Advice and assistance freely given. Write or call and see us. Demonstrations daily.

Offices and Showrooms:

Phone 8806 Gerrard. **110, STRAND, LONDON, W.C.2** Phone 8806 Gerrard.

VALVES

DELIVERY FROM STOCK.

RECEIVING.

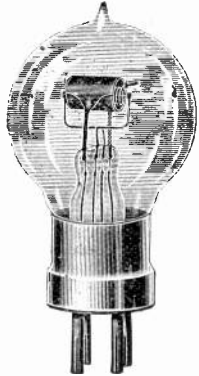

Type.	Filament Voltage.	Anode Voltage.	PRICE.
R	4	60	£0 17 6
R ₄ B	4	50	1 10 0
V ₂₄	5.2	36	1 4 0
Q	5.2	50	1 4 0
		(150 as amplifier)	
QX	5.2	50	1 4 0

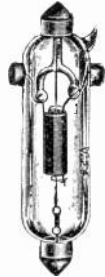

SPECIAL LOW TEMPERATURE VALVES.

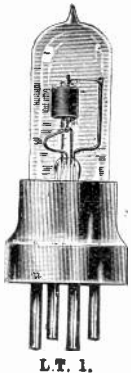

Type.	Filament Voltage.	Filament Current.	Anode Voltage.	PRICE.
L.T.1	1.8	.4	36-50	£2 10 0
L.T.3	1.8	.11	„	„

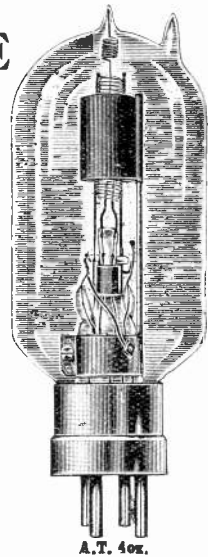

TRANSMITTING.

Type	Filament Voltage.	Anode Voltage.	PRICE.
A.T.25	5.5	UP TO 1,000	£1 10 0
A.T.40X	7	„ 1,000	2 15 0

THE

MARCONI SCIENTIFIC INSTRUMENT CO., LTD.

40 DEAN STREET, SOHO, W.1

TELEGRAMS: THEMASINCO, WESTCENT
TELEPHONE: GERRARD 7745

How did YOU receive the Election Results?

It can be confidently said that all who were listening in with a Wates Set were very pleased with the reception when the election results were broadcasted.

The reception was good—not only because Wates Sets are perfect in manufacture, but also because purchasers can avail themselves of the free advice of our technical experts, who can help them to get the best possible results under varying circumstances.

Not only do we manufacture complete Receiving Sets of the best quality, but also all component parts.

The illustration is that of the PYRAMID H.T. Battery, which we can confidently recommend to help you to get better results. It is priced as follows:—

- Filament Resistances **3/9**
- "Ideal" Valve Accumulator—
- 4-Volt 50 amp. - **25/-**
(Carriage 2/-)
- 6 ,, 50 amp. - **35/-**
(Carriage 3/-)
- Variable Condensers (of various capacities) From **6/-**
- Fixed Condensers. From **2/6**
- 3-Coil Holder, complete Unit for use with Standard Coils - **20/-**

- 15-Volt 3/6**
- 30-Volt 7/6**
- With variable plug connection.

Send 3d. stamps for our Illustrated Catalogue.

List of H.T. Batteries or Accessories—Free.

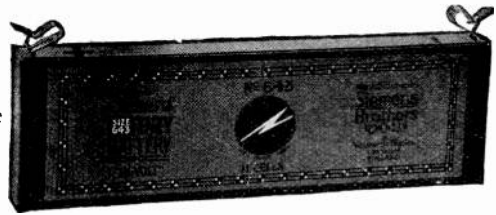

WATES BROS., 13-14, Gt. Queen St., KINGSWAY LONDON, W.C.2

ECONOMIC ELECTRIC LIMITED
ESTAB. 1896
Telephone: MUSEUM 1055.



THE "EEC" Patent

Basket and Slab Inductance Holder



Write to-day for our 36 page Radio Catalogue, 150 illustrations. Mailed post free for 4d.

J. BURNS, LTD.
Wangye Works,
Chadwell Heath, Essex.

We are actual manufacturers and can offer special advantages to the trade—send us your enquiries.

CONDENSERS.	retail price
.001 mfd.	16/- ea.
.0005	12/6 ea.
.0003	11/6 ea.
.0005	5/6 ea.
Filament Resistances	3/-
Terminals with high base	1/6 doz.
Contact Studs, with nuts	9d. doz.
Sliders, with springs and studs	9d. ea.
Ebonite Panels, cut to order	3/6 lb.
Ebonite Coil Holders	12/6 ea.

Single Valve Panels

fitted with Variable Condenser, Filament Resistance, Grid Leak and fixed Condenser, Engraved Panel and Rosewood finished Box, ready for use . . .

£4

Vulcanised Fibre and Ebonite Sheets, Rods & Tubes from stock.

THE WIRELESS WORLD AND RADIO REVIEW

THE OFFICIAL ORGAN OF THE RADIO SOCIETY OF GREAT BRITAIN

No. 173 [No. 10
Vol. XI.] DECEMBER 9TH, 1922.

WEEKLY

The Spark Transmitting System of the Eiffel Tower.

By E. M. DELORAINE, Ing., E.P.C.I.

IN a recent issue* the valve transmitter of the Eiffel Tower was described. This set has however been modified, and at the time of writing, a group of two radio transmitters has been installed in order to obtain a power of about 4 kW. in the antenna.

This article is devoted to the well-known spark transmitter, and gives a general description, while a subsequent article gives details of a recent modification of the transmitter, involving the introduction of a synchronous auxiliary rotary spark-gap. Before entering upon this

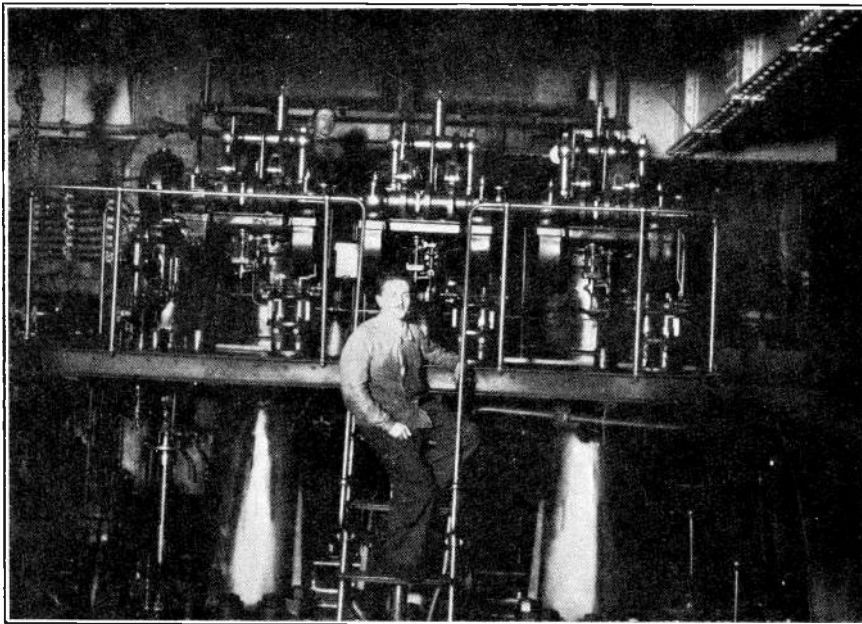

Fig. 1. The 240-H.P. Diesel Engine.

The author will not attempt for the present to give particulars of that installation, but will continue the description of the Eiffel Tower Radio Station.

**The Wireless World and Radio Review*, July 10, 1922.

description however, it should be mentioned that there are four systems of transmission that are used in turn. They are:—

(1) The Valve Transmitter already described.

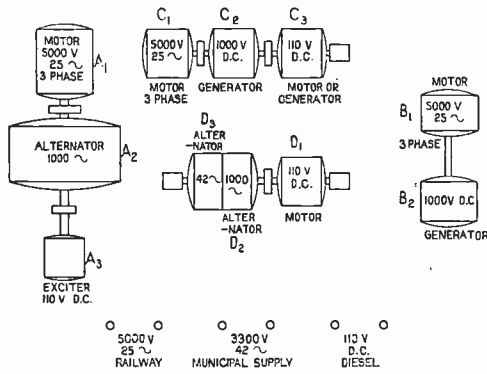

Fig. 2. Diagram showing position of machines.

- (2) The Spark Transmitter, which is the subject of the present article.
- (3) A Poulsen Arc Set.
- (4) A High Frequency Alternator.

POWER SUPPLY.

In arranging for a supply of power, the first consideration has been to avoid, as far as possible, all risks of an enforced interruption in the transmission. Electrical energy is required for use in the following forms:—

- (1) Monophase Alternating Current at 1,000 cycles for the Spark System.
- (2) Direct Current at 1,000 volts for the Poulsen arcs.
- (3) Monophase Alternating Current at 220 volts and 42 cycles for the operation

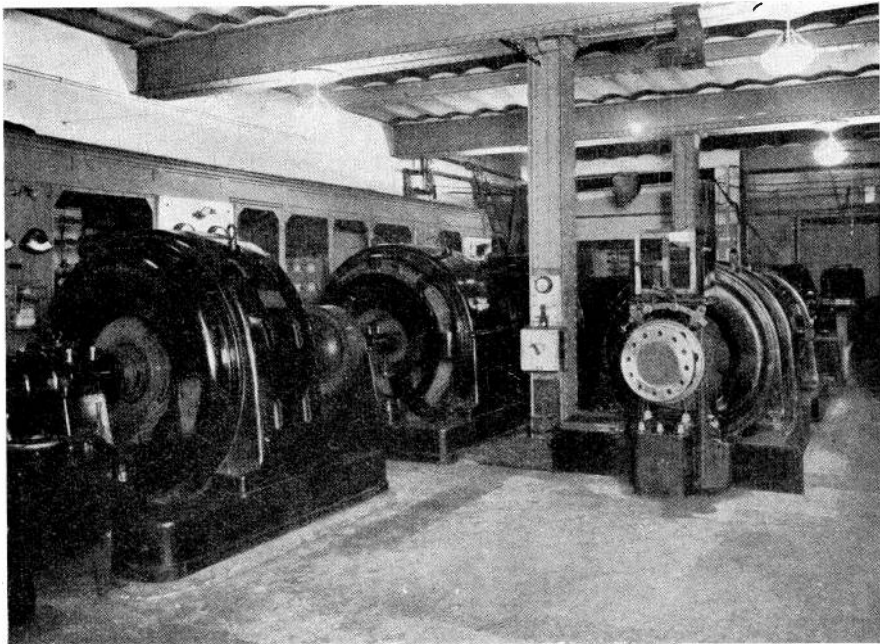

Fig. 3. 300-kW. Generator which supplies energy for the Transmitter at 500 volts and 1,000 cycles.

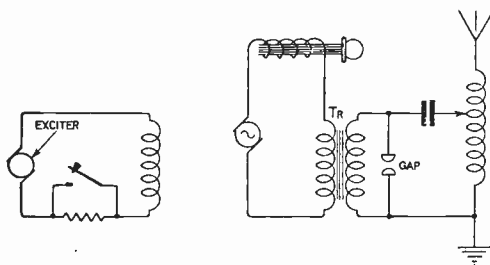

Fig. 4. The Transmitter circuit.

of the air compressors mentioned below. Electrical energy is also required for lighting. There are two outside sources of power, viz. :—

- (1) A Three-Phase Supply, taken from the State Electric Railway at an effective voltage of 5,000 and a periodicity of 25 cycles. This is the cheapest source of power, and it is consequently used whenever possible.
- (2) A Monophase Supply, taken from the main municipal circuit at 3,300 effective volts and 42 cycles. It is stepped down by a transformer to 220 volts for the power

circuits and to 110 volts for the lighting circuits.

As a precaution against any emergency that might arise, a supply of direct current may be generated in the station itself. For this purpose there are four motor-generator sets, located in the base of the Tower, the whole, when working simultaneously, being capable of delivering 300 kW. at 110 volts. A 240-H.P. Diesel engine (Fig. 1) constitutes the main unit, and drives by means of a belt a dynamo of corresponding power. The engine is of the vertical type with three cylinders, the fuel is fed through the pistons, and starting is effected by means of compressed

group C, we have again a three-phase motor C_1 and a 1,000-volt D.C. generator C_2 , but we have, in addition, a D.C. generator C_3 . The latter functions as a motor, when connected to the D.C. supply, but may be coupled as a generator to D., when C_1 is being driven by the three-phase supply. D_1 serves to drive D., and D., the former being a substitute for A., and the latter being utilised to generate 220 volts at 42 cycles, should the municipal supply fail. The many different ways in which the groups of machines may be coupled so as to obtain electrical energy in the three forms mentioned above, do not require further elaboration.

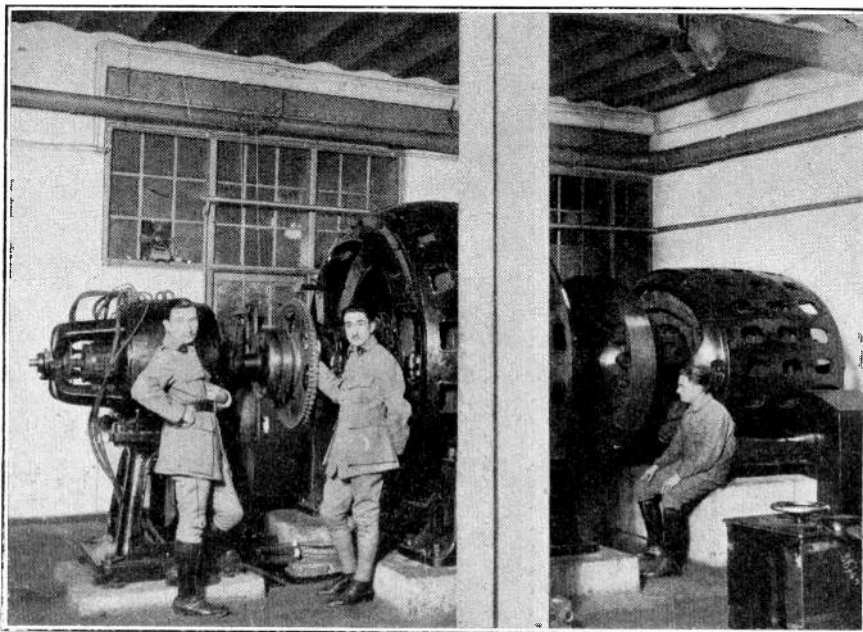

Fig. 5. Asynchronous 3-phase motor coupled to 500-kW. Generator which feeds the Spark Transmitter.

air in one of the cylinders. The other three units are driven with water-gas.

Fig. 2 indicates the positions of the machines in the Power Room, and it will be seen that they have been arranged in four groups, all the machines of any one group being on the same shaft. Group A consists of a motor, A_1 , that may be driven by the 5,000 volts three-phase supply, and two other machines A_2 and A_3 . The latter, when driven by A_1 , provides a field current for A_2 which generates A.C. at 1,000 cycles. Group B consists of a motor B_1 which is designed for use on the three-phase supply, and which drives B_2 , a direct current generator at 1,000 volts. In

OTHER SOURCES OF POWER.

In addition to the above we may mention a storage battery of 300 ampere-hours at 110 volts and an air compressor. Practically all the signalling circuits are supplied from the former, while the latter is used to work the pneumatic relays and to provide an air-blast to remove dust from the machines.

THE SPARK SYSTEM.

As is well-known, the Spark System of Wireless Telegraphy comprises three main circuits as follows (Fig. 4) :—

(1) A low-voltage and low-frequency circuit, comprising :—

(a) An alternator for supplying energy

to the set. The alternator is of a special design, as it is essential to use a frequency between 500 and 2,000 cycles to obtain a musical spark. Further, it is desirable to use a high inductance since the alternator is practically short-circuited during the passage of each spark.

(b) The primary of a step-up transformer.

(c) A variable inductance, so adjusted that the natural frequency of the circuit is slightly higher than that of the alternator, this being the best way to avoid a sudden increase of current when the spark passes. By this means also, an auto-

(b) A spark-gap across the secondary winding of the transformer. This permits the energy to accumulate in the condenser and the voltage to increase, until the gap breaks down.

(c) A condenser, which must be capable of handling a very large amount of energy without overheating or breakdown.

(d) A small inductance in series with the condenser which constitutes an oscillating circuit resonant at radio frequency. This inductance is magnetically coupled to the aerial circuit.

When the spark passes across the gap, it permits an oscillatory discharge of the con-

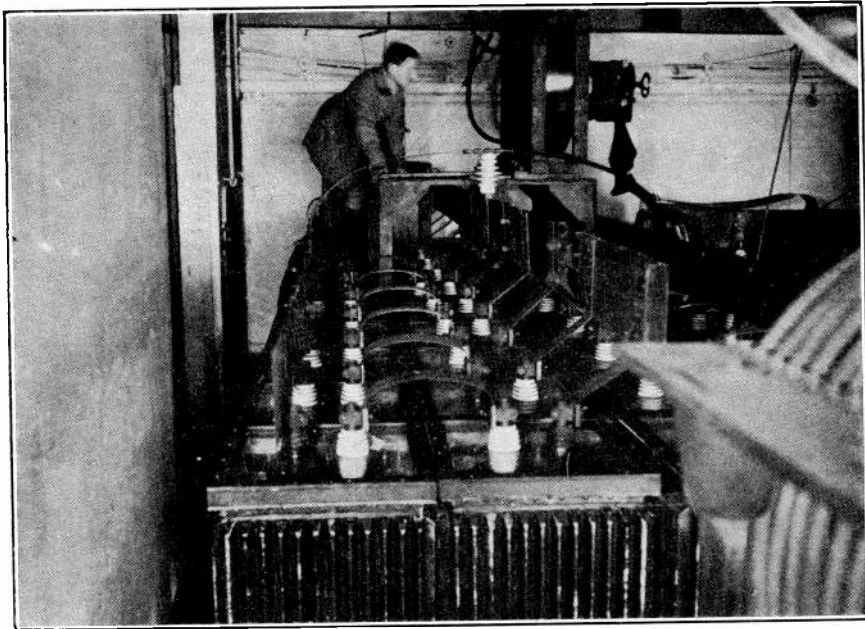

Fig. 6. The Transmitting Condensers. Total capacity 0.55 mfd. and designed to employ 70,000 volts.

matic regulation of alternator speed is obtained, for when the speed increases slightly the load increases considerably as the frequency approaches more closely to the resonant frequency, this increased load checking the increase in speed.

(2) A high-voltage circuit, which may be divided into a low frequency circuit and a high frequency circuit, and comprises:—

(a) The secondary of a step-up transformer. This is necessary in order to obtain sufficient energy in the condenser. The end coils of this transformer must be very well insulated as they act as choke coils for the high-frequency current.

denser at radio frequency through the coupling inductance, the high frequency energy being transferred thence to the antenna.

(3) The antenna circuit or radiating circuit which works only at radio frequency. SUPPLY OF THE SPARK SYSTEM.

The Spark System of transmission requires monophasic alternating current at 1,000 cycles per second. It is fed by either of the alternators shown in Figs. 4 or 5. Fig. 4 shows an alternator made by the "S.A.C.M." (Société Alsacienne de Construction Mécaniques) of 300 kW. and 500 volts, able to supply 600 amperes at 833 revolutions per minute. The motor, as explained before, is a 370 H.P.

D.C. machine with a normal current of 2,500 amperes. Fig. 5 refers to the group, known as "éclairage électrique," which is driven by (70,000 volts) to which they are subjected, these condensers must be of special construction. They are made of flat aluminium sheets,

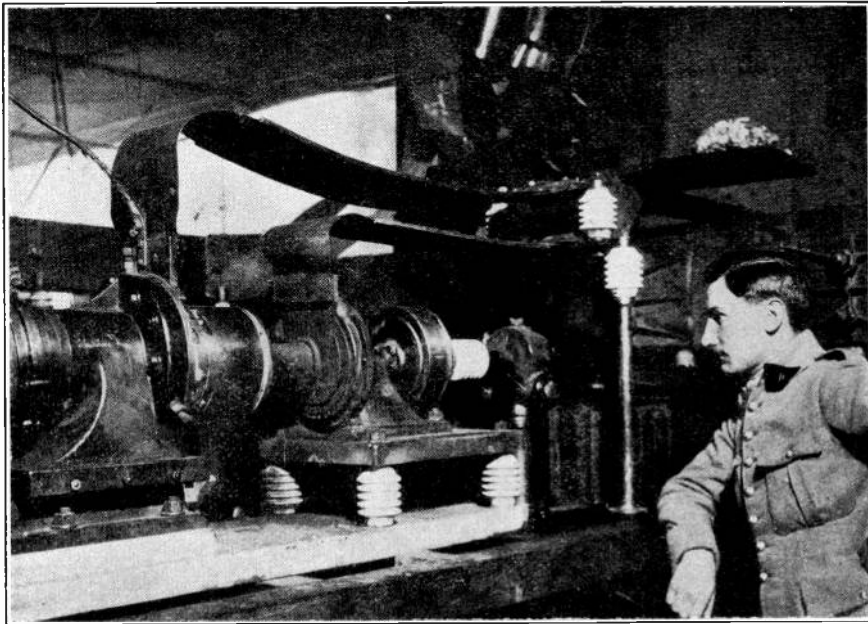

Fig. 7. Spark-Gap, with revolving eccentric electrode.

an asynchronous three-phase motor of 350 H.P. under a pressure of 5,000 volts. It delivers 500 kW. at 900 volts and operates at 500 r.p.m.

The field current is supplied either from the bus bars at 110 volts or by an exciter on the main shaft, as seen in Fig. 5.

Two step-up transformers are working in connection with the two alternators, the first one being of 950 kW., ratio 16 to 1, primary 1,500 volts, 630 amperes; secondary 24,000 volts 50 amps.; the second one 810 kW., ratio 20 to 1, primary 1,500 volts, 630 amperes; secondary 30,000 volts 27 amperes.

The oscillatory circuit includes a number of condensers having a total capacity of 0.55 mfd. On account, however, of the high pressure

separated by glass plates, and immersed in corrugated oil tanks (Fig. 6), the corrugation being advisable in order to facilitate the dissipation of the heat generated by dielectric losses. The condenser units, each of which has a capacity of 0.05 mfd. are connected in series parallel.

A form of spark-gap in use employs as one electrode, a cylindrical tube of pure copper, inside which a second electrode revolves eccentrically (Figs. 7 and 8). The latter has a mushroom shape and its movement displaces the points on the electrodes, at which sparking takes place. The object of this displacement

is to prevent excessive heating of any point of the electrodes, as this might lead to arcing across the spark-gap. Furthermore, further

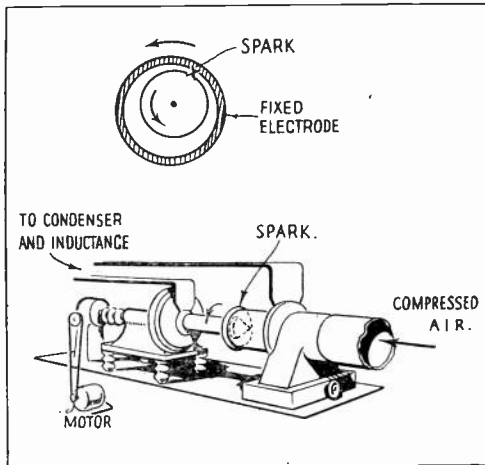

Fig. 8.

cooling is effected by an air blast, which is directed from a 30 H.P. air compressor on to the spark (Fig 9). The gap, which is ordin-

The self-inductance of the oscillator circuit is a part of the direct coupling to the antenna circuit, which comprises four turns of very

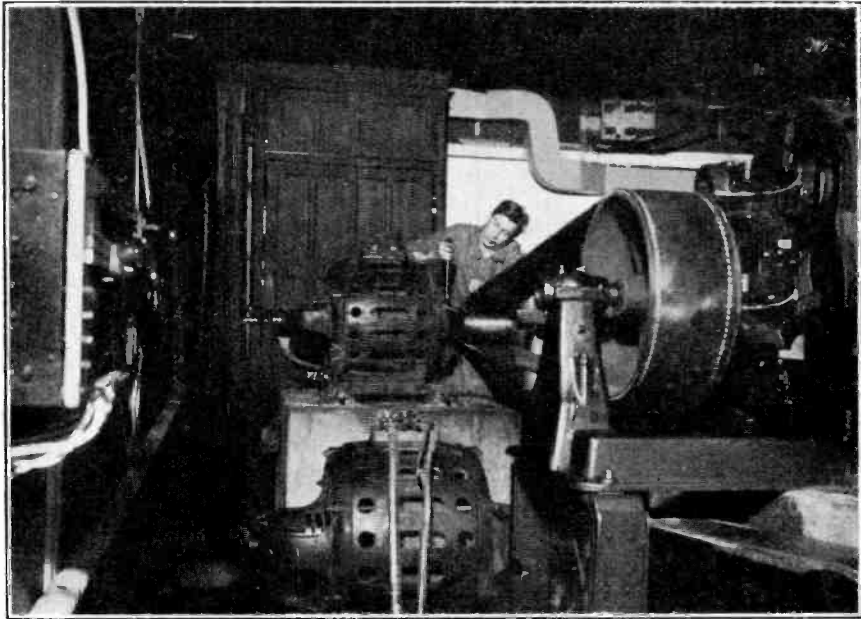

Fig. 9. The Motor-driven Air Compressor which produces the Air Blast for cooling the Spark-Gap.

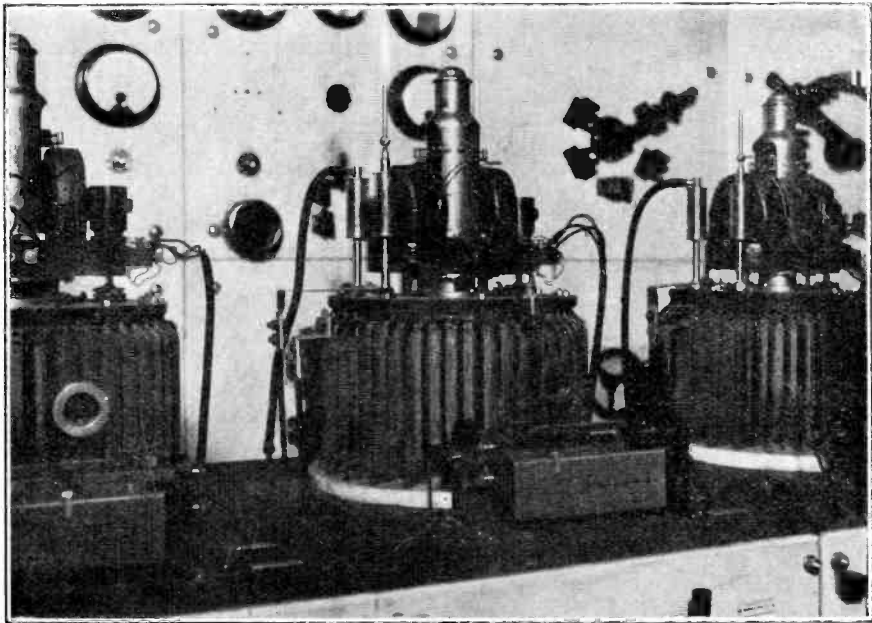

Fig. 10. Mercury circuit breakers, which interrupt the excitation current of the Alternator for signalling. The gap, which is ordinarily $\frac{3}{8}$ -inch, may be varied between limits without interrupting transmission.

large copper tape (See Fig. 6). The antenna inductance is made of a brass pipe of 40 turns

of one yard diameter. The range of wavelengths is from 2,200 to 3,600 metres, the normal length being 2,600 metres. The antenna current is 80 amperes and the frequency of the sparks 500, *i.e.*, one spark for every two periods of the alternator.

The signalling is done by varying the excitation current of the alternator. For this purpose the use of a mercury turbine is necessitated by the difficulty in obtaining a good and rapid, though repeated, make and break of a current of about 150 amperes, as metallic contacts would soon be burnt up, the closing of the circuit by means of the key results in a big increase of exciting current with consequent production of sparks across the spark-gap.

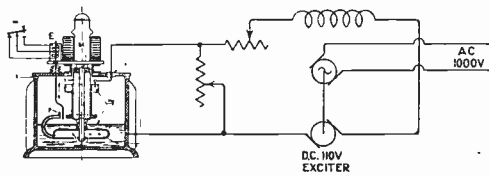

Fig. 11. Circuit Breaker for Signalling.

Fig. 11 gives a schematic diagram of the device. A centrifugal pump C, driven by a

vertical electric motor M, compresses mercury at the bottom of a metallic tank (Fig. 10), and projects it horizontally on to a bronze ring, revolving with the motor and connected to a terminal insulated from the tank. A shutter P, which moves up and down, allows the mercury to pass when it is up, and obstructs its passage in the down position. When the mercury flows past, it makes metallic contact between the bronze ring and the tank itself, and the resistance is short-circuited. When the shutter is down, the mercury falls back into the tank. The function of this device is now, perhaps, somewhat plainer. The sparks, which occur when the circuit is broken, exist between the mercury column and the bronze ring. The former is prevented from oxidation by the precaution of having an atmosphere of coal gas in the tank. As the bronze ring revolves as mentioned above, the spark occurs at different points. This prevents overheating, which would soon destroy any stationary electrode. The Morse key is set in a 110 volt D.C. circuit and actuates the shutter by means of a coil in this circuit.

Broadcasting and the Experimenter in America.

We make no apology for reproducing on this page the cover of the November issue of the American Amateur journal, *Q.S.T.* We feel sure that readers will appreciate all that this cover design embodies.

For many months past amateurs in America have viewed with the deepest concern the enormous increase in the activities of broadcasting stations, fearing that the time would come when experimenters would find it impossible to make room for themselves in the jazz-echoing aether. *Q.S.T.* in its cover design encourages the amateur not to be despondent. The American Government,

in the person of Uncle Sam, is reminding the amateur that his rights are just as well guarded and cared for as the privileges which have been given to the broadcasters.

Let the assurance of the American Amateur be felt by the British Amateur who should never entertain the fear that he will be let down by the British Post Office under whose authority his licence has been issued.

The British Amateur too is disposed to feel uneasy lest his opportunities for Experimental work should be seriously handicapped in order to make way for Broadcasting in this country.

A Design for a Coil Holder

By ALLANDALE.

HAVING bought a number of honey-comb coils recently, it was necessary to obtain a coil-holder.

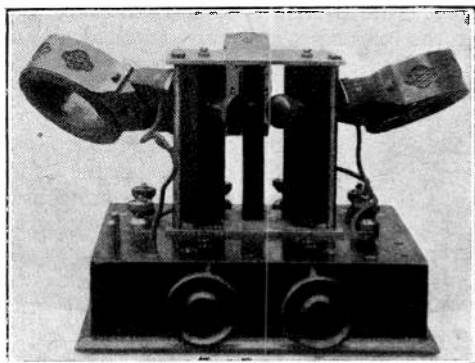

Fig. 1.

This seemed to be a piece of apparatus well within the ability of an amateur to construct, as a great knowledge of wireless is not required.

I therefore decided to make one, and the result is shown in the photographs Figs. 1, 2, and 3, while Fig. 4 shows the underside with the bottom removed.

It will be seen that it is constructed to carry three coils, the outside ones having the ordinary opening movement and in addition a turning movement to assist in fine tuning.

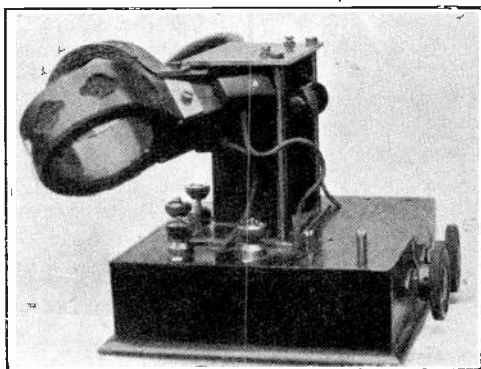

Fig. 2.

The most difficult parts to make are the coil-holder sockets, these have to be made accurately to 9/16 in. centres for the De Forest type of coil and are shown in detail in Fig. 5.

I have no doubt, if any trouble is found in making these, that the coil fitting sold for mounting could easily be adapted by cutting off the back screws and fastening the flexible leads to the screws used for securing the fibre band, as these are screwed into the sockets.

It will be seen in Fig. 5 that the ebonite is $\frac{1}{2}$ in. thick \times $1\frac{3}{8}$ ins. long \times $1\frac{1}{8}$ ins. wide, with the ends rounded. Two holes $\frac{5}{16}$ in. diameter are drilled $\frac{3}{8}$ in. deep at 9/16 in. centres into which two pieces of brass are fitted drilled $\frac{3}{16}$ in. diameter, $\frac{1}{2}$ in. deep for the ordinary De Forest type of coil, or if Burndept coils are used the centres should be 15 millimetres instead of 9/16 in.

Two holes are tapped to take No. 6 screws through the side of the ebonite into the solid

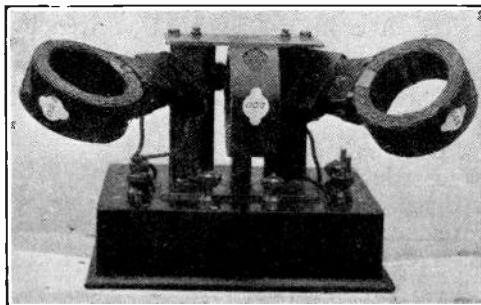

Fig. 3.

end of the sockets to connect the flexible wires to the sockets.

In the stand shown in the photographs the wires were passed through holes in the ebonite and soldered to the ends of the sockets; a little shellac was put on the sockets before they were pressed into the holes in the ebonite. In this case the holes must be drilled at the end of the socket hole.

To carry these holders a brass plate $\frac{3}{32}$ in. thick is provided of the same size as the ebonite, and secured by two No. 4 BA counter-sunk screws; in the centre of this a hole is drilled and tapped 2 BA to receive the reduced end of a 3/16 in spindle, which enters the ebonite $\frac{1}{4}$ in. and is prevented from unscrewing by a 1/16 in. brass pin being passed through the ebonite and spindle.

The plain part of the spindle is 11/16 in. long, and is reduced and screwed No. 2 BA

for a further $\frac{7}{16}$ in. to take a Government pattern insulated terminal head.

The stand itself has an ebonite base 7 ins. \times 5 ins. \times $\frac{1}{4}$ in. thick as shown in Figs. 7 and 9. This carries all the different parts and terminals, and is fitted in a mahogany box with a $\frac{1}{8}$ -in. margin round. The box is 2 ins. deep with a $\frac{5}{16}$ -in. bottom secured by screws.

Two brass plates $\frac{3}{32}$ in. thick, $3\frac{7}{8} \times 2\frac{1}{4}$ ins. (Figs. 7 and 9) are required to form the top and bottom and form the centres in which the uprights are held. Two holes for the $\frac{3}{16}$ -in. pillars are drilled to take No. 4 BA screws, the plates are then bolted together with two bolts and the edges filed up true and square.

The rest of the holes can now be drilled while the plates are fastened together so that the positions of the holes in the two plates will correspond.

The holes for the moving uprights are drilled

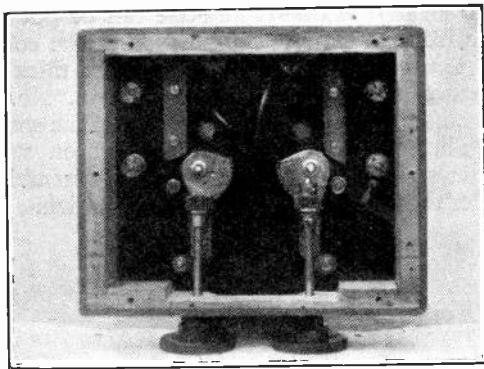

Fig. 4.

for No. 4 BA tapping, but those in the lower plate will require to be reamed out to $\frac{3}{16}$ in. to take the bottom centre. The two holes in the top plate are tapped 4 BA and are provided with pointed centre pin and lock nut.

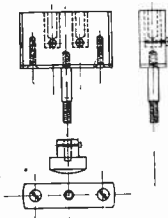

Fig. 5.

The plates are then separated and fastened on to a wood block with brass shoe brads, filed smooth, then polished with fine emery and oil and lacquered.

Two $\frac{3}{16}$ in. diameter pillars are required with the ends reduced and screwed No. 4 BA, the lower ends being left long enough to pass through the ebonite with nut and washer underneath and to serve

for fastening the whole to the base as shown in Fig. 9.

The uprights to carry the coil-holders already described can be made next, and these are shown in Fig. 6. They are $\frac{7}{8}$ in. \times $\frac{1}{2}$ in. \times $3\frac{9}{16}$ in. long.

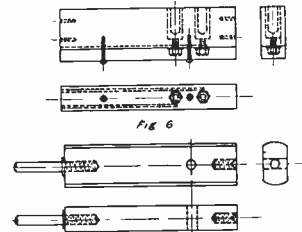

Fig. 6.

A small piece of $\frac{3}{16}$ in. brass rod $\frac{7}{16}$ in. long is screwed into the top and counter-sunk to take the pointed end of the pointed centre; the bottom has a piece of $\frac{3}{16}$ -in. brass rod screwed in and left projecting 1 in. A little shellac is put on the thread before the rod is screwed home and this prevents it working loose, a $\frac{3}{16}$ in. brass washer is put on this rod and forms a bearing preventing the upright rubbing on the brass bottom plate.

The centre upright, shown in Fig. 6 carries the two coil sockets, but in this case the sockets have screwed ends and pass through the ebonite, being fastened with nuts to which connecting wires are attached. The wires may be soldered to the ends. Two saw-cuts down the back as shown receive the No. 18 D.C.C. wire to connect to the centre terminals and are covered in with a piece of $\frac{1}{4}$ -in. ebonite secured by

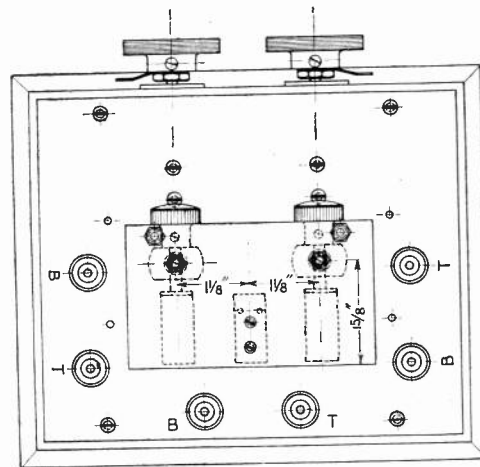

Fig. 7.

two No. 8 BA round-headed screws. Insulating tubing is slipped over the lower end of these wires and saw-cuts are enlarged at the lower end to allow it to pass $\frac{1}{4}$ in. up where the ebonite secures it, the tube guards against

any leakage where the wires pass through the brass plate. This piece is secured to the top and bottom plates with 4 countersunk No. 6 BA brass screws and with the $\frac{3}{16}$ in. brass pillars bind the plates together to form a support for the two movable uprights.

The $\frac{3}{16}$ in. spindle on the socket holders (Fig. 5) is put through the $\frac{3}{16}$ in. hole drilled

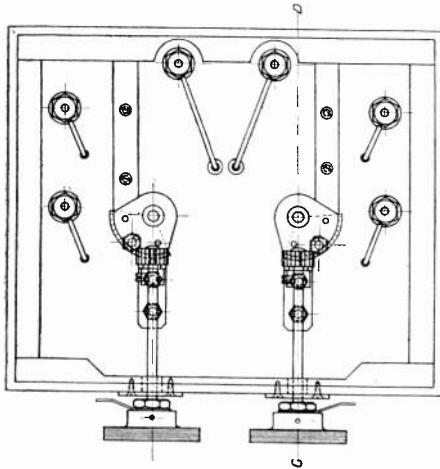

Fig. 8.

in the centre of the movable uprights with a phosphor bronze spring washer between and the insulated terminal screwed up until the holder can be turned but without being too loose; a No. 8 screw in the side of the terminal head prevents unscrewing.

The two flexible wires secured on the outside of the socket holders are passed through the small holes in the ebonite top and secured to the terminals at the sides, care being taken to allow enough slack to admit of socket holder movement.

In Fig. 7 the terminals T and B respectively indicate the top and bottom sockets.

When assembled, this completes the top part of the coil holder. To move the outside uprights I secured a "Meccano" crown wheel of 50 teeth and two pinion wheels of 20 teeth, the crown wheel I cut in 3 equal parts with a hack saw (but two parts would be better) and riveted a piece of sheet brass $\frac{1}{16}$ in. thick shaped as shown in Figs 8 and 9, to take a new centre-piece made from $\frac{3}{8}$ -in brass rod $\frac{7}{16}$ in. long and bored $\frac{3}{16}$ in. diameter hole.

This was a lot of trouble and I should advise the purchase of two crown wheels which would only require the centre hole enlarging to $\frac{3}{16}$ in. or the brass rod in the upright could be made less in diameter to fit the wheels.

In either case the crown wheel or segment is secured to the pin on the upright by a $\frac{3}{32}$ in. set screw through the side of the boss.

Each pinion is mounted on a piece of $\frac{3}{16}$ in. brass rod reduced to fit and either secured with a $\frac{3}{32}$ set screw or the end of the shaft and riveted over.

An inside bearing is made from a piece of $\frac{3}{32}$ in. sheet brass $\frac{7}{16}$ in. wide, bent at right angles and secured to the ebonite top by two countersunk No. 4 BA screws and nuts.

A "Meccano" collar bored out to $\frac{3}{16}$ in. and placed up to this bearing keeps the pinion in place.

The shafts are carried through the back of the coil stand, the ends being screwed 2 BA to take an ebonite knob $1\frac{1}{2}$ in. diameter, a pointer being provided made from $\frac{1}{32}$ in. brass and secured to the knob by a No. 8 BA countersunk screw.

To prevent this knob from unscrewing in use a No. 8 BA screw is put through the boss and shaft. If desired, a scale can be put on the front to indicate the position of the coils.

A small oval brass plate $\frac{1}{16}$ in. thick is secured to the frame with two $\frac{3}{8}$ -in. No. 3 wood screws to carry the front end of the shaft.

The bottom of the case is put on with screws since the shafts have to be assembled after the ebonite top is secured in position.

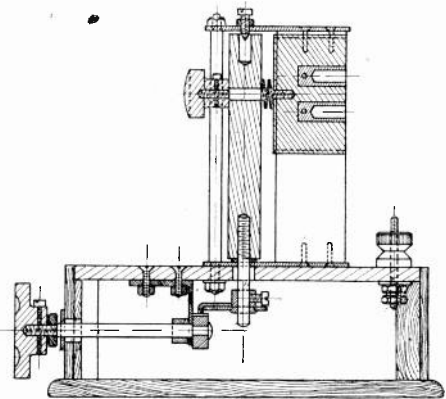

Fig. 9.

The coils are shown in the drawings with $1\frac{1}{8}$ in. between centres as it is found that with 1 in. centres some of the coils will not come together owing to small defects in winding. This could be reduced to $1\frac{1}{16}$ in. if desired.

To avoid capacity effects from the hands, the coil stand could be fixed on a bracket and the centres of the uprights carried down to the operating board.

Electrons, Electric Waves, and Wireless Telephony--X.

By DR. J. A. FLEMING, F.R.S.

The articles appearing under the above title are a reproduction with some additions of the Christmas Lectures on Electric Waves and Wireless Telephony given by Dr. J. A. Fleming, F.R.S., at the Royal Institution, London, in December and January, 1921-1922. The Wireless Press, Ltd., has been able to secure the serial rights of publication, and any subsequent re-publication. The articles are therefore copyright, and rights of publication and reproduction are strictly reserved.

V.—THE PRODUCTION AND DETECTION OF LONG ELECTRIC WAVES.

I.—ELECTRIC OSCILLATIONS.

AS already stated, we have reasons for believing that in metals, carbon, or other substances which are conductors of electricity, there are free electrons which are moving irregularly with very high speeds in the interstices of the atoms of matter, or jumping from atom to atom.

Conductive materials such as metals are built up of atoms which easily lose one or more electrons from their outer shells or orbits. These detachable electrons are called the *valency* electrons, and it is probably one or more of these that become free to roam about in the inter-atomic spaces.

From certain facts we can infer that in a metal there are about as many free electrons as there are atoms in any given volume. In those substances we call non-conductors but which Faraday appropriately named *dielectrics*, such as glass, ebonite, paraffin wax, mica or shellac, the number of free electrons is very small, but under the action of electric force certain of the electrons in the atomic orbits or structure can be displaced or strained elastically, so that when the electric force is removed they spring back to their old positions in the atoms.

We can thus cause in metals and conductors generally, by means of electric force, a drift of the free electrons which is called an electric current, but in dielectrics we can only produce an electron displacement or strain. The drift motion of the electrons in the case of the electric current creates, as we have seen, a magnetic force which is distributed round the conductor in closed lines embracing it. In the case of a straight wire conveying an electric current with return wire at a con-

siderable distance, the lines of embracing magnetic force due to the drifting electrons are circles whose centres are in the wire and whose planes are perpendicular to it.

In considering this effect called electric displacement in dielectrics, Clerk Maxwell, whose scientific thought on this subject was epoch-making in its importance, saw that it would be logical to conclude that an electric displacement *whilst it was being made or removed* was equivalent to an electric current and should therefore produce a magnetic field in the same way as does a conduction current in conductors. We have then to distinguish between conduction currents and displacement currents in one sense, but in another they are quite identical and both involve the production of a magnetic force or field embracing the current.

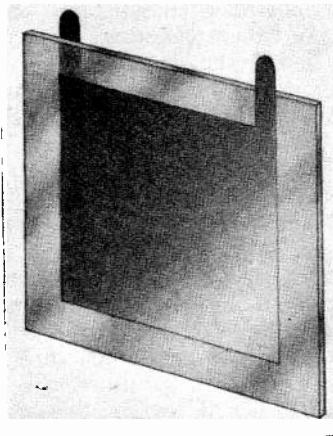

Fig. 47. A Leyden Plate or Electrical Condenser, consisting of a sheet of glass or other dielectric partly covered on both sides with tin foil or sheet metal.

Let us next consider a compound circuit comprising a sheet or layer of dielectric, say glass contained between two sheets of metal, made in fact like a sandwich, the meat being the glass and the two slices of bread the metal sheets. Such an arrangement is called a condenser or Leyden pane (see Fig. 47).

Suppose we give to one sheet of metal a charge of negative electricity. This implies that we force into it an excessive number of free electrons over and above those naturally present in it.

Owing to their mutual repulsion the result is that the displaceable or mobile electrons in the sheet of glass are all strained or displaced as far as possible away from this electron super-charged metal plate. Also the free electrons in the other metal plate move as far away as possible from the super-charged plate. If this extra electron charge has been given by an electrical machine or by a battery, it implies that at the opposite pole of this battery or electrical machine there is a deficit of electrons. Hence if we connect this last named pole with that plate of the condenser which has not been charged with extra electrons, a number of electrons equal to the excess in the other plate will return to the battery or electrical machine, whilst the plate itself is left with a deficiency of free electrons.

As regards the condenser the state then is, that in one metal plate there is an excess of free electrons, in the other plate a deficit and in the intermediate dielectric plate of glass the mobile electrons are strained or displaced from their normal positions in their atoms, and this elastic displacement represents a store of potential energy, just as does a stretched or bent steel spring. The condenser is then said to be charged or have energy stored up in it. The energy of that charge is measured by half the product of the charge, reckoned in extra electrons, of one plate and the potential difference or voltage between the two plates.

The reader should note that in electrical phenomena the potential difference of two points is the exact analogue of the temperature difference in thermal or heat phenomena, and of difference of level or pressure in the case of hydraulic effects or flow of water.

In the next place let us suppose that the two metal plates of the condenser are connected by a metal wire. The result is that electrons begin to drift through this wire from the plate which has an excess of them to

the plate which has a deficiency of them, and at the same time the electrons in the dielectric or glass plate which are strained or displaced, begin to return to their normal positions. The return of electrons is, however, not merely by a uni-directional motion.

Suppose that instead of connecting by a wire two conductors having respectively an excess and a deficit of electrons in them, we were connecting by a wide pipe, in which was a tap suddenly opened, two vessels, in one of which there was an excess of air under pressure, and in the other a partial vacuum or deficit of air. On opening the tap the air in the full vessel would rush over into the empty one, but owing to the mass or inertia of the air it would at first overrush and then rush back again and equilibrium of pressure would only be established after a series of to and fro rushes of air each less than the last. These are called aerial oscillations.

In exactly the same manner, if we connect suddenly the two plates of a charged condenser, the electron equilibrium or equality is only established after a series of rapid movements of electrons to and fro in the wire which gradually die away. These are called *electric oscillations* and are in fact brief currents of electricity alternately in one direction and then in the opposite, which decrease at each reversal. This is termed a damped train of electric oscillations. It can be represented by the ordinates or heights of a periodic but decrescent curve, as in Fig. 48, in which horizontal distances represent time and vertical distances the current in the connecting wire.

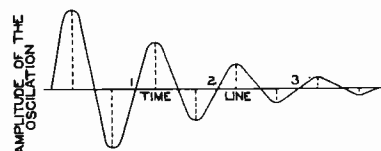

Fig. 48. A Graph or delineation of a damped electric oscillation.

There are then two terms which must be defined as regards the condenser and the connecting wire and these are *capacity* and *inductance*.

If we wished to measure in a certain way the capacity of an airtight vessel we might state it as the weight or quantity of air that the vessel would hold when pumped full up to one atmosphere of pressure or, say, 14½ lbs. per square inch. In the same manner we define

the electrical capacity of a condenser as the quantity of electricity it holds when the potential difference of its plates is one volt or one unit.

The exact relation between the quantity of electricity Q or number of excess electrons in the negative plate, the potential or pressure difference V of the plates and the capacity C is expressed by the equation.

$$C = \frac{Q}{V}$$

or numerically, capacity is measured by quantity divided by voltage. The consistent units in which these things are measured are, voltage in volts, quantity in coulombs, and capacity in farads. As, however, the capacity of a condenser of one farad is extremely large, its millionth part, called a *microfarad*, is usually taken as the unit of capacity. We have seen that the quantity called a coulomb is equal to six million billion electrons; so that a condenser has a capacity of one microfarad when, if six billion excess electrons are put on one plate the potential difference of the plates becomes one volt or about 2/3rds of that of the poles of a single dry Leclanche battery cell.

In the next place as regards the wire with which we connect the plates of the condenser. It has two special qualities which can be measured in appropriate units. These are, first, resistance, and secondly, inductance. The electric resistance of a conductor is that quality of it in virtue of which the electric current energy is converted into heat in the wire.

Now this heat consists in part in the energy of irregular motion of the free electrons in the wire, and the electric current is the regular or uni-directional drift or movement of the free electrons in the wire, which is superimposed on the irregular motion.

As the electrons are struggling along in one direction in the wire under the guidance and pressure of the electromotive force urging them, they are continually bumping up against the atoms of the metal and against one another and having their own course changed and some of the energy of their drift or regular motion converted into energy of irregular motion or heat.

The greater this irregular motion, that is, the higher the temperature of the wire, the less in general is the effect of the electromotive force in producing a uni-directional drift. This means to say that for a given electro-

motive force the current is less; in other words, the electrical resistance is greater.

On the other hand, the lower the temperature of the wire the less is the irregular motion of the free electrons and the greater is the uni-directional drift under a given electromotive force. Hence the electric resistance of pure metals is found to decrease with fall of temperature.

The matter is, however, a little more complicated than the above statements imply. We may regard these free electrons in the metal as the molecules of a kind of gas, and, as in the case of gas molecules, their irregular velocities are different, some moving fast and some slow. The velocity is distributed in accordance with Maxwell's law for gas molecules and the electrons have a certain mean free path between collisions with each other and with the atoms. It is only during the time of this mean free path that the impressed electromotive force is able to act upon them and impose the drift motion in one direction, which constitutes the electric current.

If we call N the number of electrons per cubic centimetre and u the drift velocity of each parallel to the axis of the wire and X the electric force acting on the electron, then the electric current I per square centimetre is measured by the product Nu . If t is the time between two collisions and m the mass of each electron, then the drift velocity acquired in the free time between two collisions

is $\frac{1}{2} X \frac{e}{m} t = u$. Again, if l is the mean free path and v is the average irregular velocity of the electron, we may take l to be equal to the product vt , and if the drift velocity u is small compared with v , then the current I is given by the equation

$$I = \frac{1}{2} \frac{NXe^2lv}{2mv^2}$$

But mv^2 is twice the kinetic energy of the electron due to the irregular motion.

If we regard these free electrons as forming a kind of gas, then from the kinetic theory of gases we know that the average energy of a gas molecule is proportional to the absolute temperature T , that is, to the temperature measured from the absolute zero, which is 273° below zero centigrade.

Hence, to convert temperatures measured on the centigrade scale into absolute temperatures, we add 273° to them if the centigrade temperature is above zero centigrade, viz.,

the melting point of ice, and if the centigrade temperature is below zero centigrade we subtract it numerically from 273° to obtain the absolute temperature.

Thus $+15^{\circ}\text{C} = 288^{\circ}\text{abs.}$,

but $-180^{\circ}\text{C} = 93^{\circ}\text{abs.}$

If then we consider the same holds good for the free electrons, we see from the previous equation that the ratio of electric force X to current I , which is a measure of the electric resistance of the cubic centimetre of the metal, is proportional to the absolute temperature, and therefore falls with it.

Experiments made in 1893 by the author, in conjunction with Sir James Dewar, showed that in the case of pure metals when cooled in liquid air to about 80° absolute, there was a fall in electric resistance approximately proportional to the decrease in absolute temperature, but other experiments made subsequently by Sir James Dewar with liquid Hydrogen, giving low temperatures, and later on at still lower temperatures by Prof. H. Kamerlingh Onnes of Leyden, in Holland, with liquid Helium at a temperature of about 4° absolute, showed that the resistance of pure metals at very low temperatures does not decrease continually according to the same law. For many metals the electrical resistance tends to a minimum constant value at temperatures near the absolute zero. On the other hand, in the case of certain metals in a state of great purity such as mercury, tin, thallium and lead, the electric resistance at temperatures near 5° absolute suddenly falls from a finite value to a nearly zero value. Thus, in the case of lead at about 7° absolute the resistance very suddenly decreases, and at a temperature of 2.45° absolute its electrical resistance is only 50-millionths of that which it has at 273° absolute, or at 0° centigrade, the melting point of ice. In this condition the metal becomes, as Onnes calls it, a *super-conductor*. In this state very large currents may be passed through the intensely cooled metallic wire without creating in it any heat, because it has little or no resistance.

Moreover, if a powerful magnetic field is made to traverse a ring of lead in the state of super-conductivity and then is withdrawn, an electric current, called an induced current, is generated in the ring which lasts for several hours, whereas at normal temperatures it would not last more than a fraction of a second.

A wire, which is a conductor of electricity, possesses, however, another quality called

inductance, also due to the properties of these little free electrons which swarm in it. We know that a heavy object such as a motor-car or railway train, when once set in motion cannot be instantly stopped. In consequence of its mass (m) and velocity (v) it possesses, as already experienced, kinetic energy measured by $\frac{1}{2}mv^2$. This energy has to be used up in overcoming friction or some resistance, or in doing some form of work before the velocity can be reduced to zero. We have seen also that an electron in motion possesses electric mass, and hence when in motion has a store of kinetic energy.

Accordingly an electric current in a conductor, which is a procession of electrons moving together in one direction, acts as if it were a massive body, and cannot be instantly started or arrested. If i is the current in a conductor at any instant, then the energy stored up by it in the form of an electromagnetic field is measured by the quantity $\frac{1}{2}Li^2$ where L is called the inductance or electric inertia of the circuit.

The current energy depends upon two factors, viz., the current i and the inductance L , just as the kinetic energy of a moving mass depends upon the mass m and the velocity v .

By analogy we can see that if the electric current energy $\frac{1}{2}Li^2$ corresponds to motional energy $\frac{1}{2}mv^2$, then the product Li corresponds to mv or to the momentum of the moving body. The product of inductance L and current i is called the *electric momentum*. Again we have shown that when a mass is set in motion by a force, the latter is measured by the rate at which it produces or destroys momentum. Hence again by analogy, when an electric current is changing, the electromotive force corresponding to this change must be measured by the time rate of change of the electric momentum or of Li . It can be shown that this electric momentum is a measure of the number of its own lines of magnetic force which are self-linked with the circuit.

It is convenient to denote the rate at which a quantity is changing with time by a *dot* put over the letter which denotes the quantity itself. Thus if P stands for the population of a country at any moment, \dot{P} stands for the rate at which it is increasing, and $-\dot{P}$ for the rate at which it is decreasing by births, deaths, and immigration or emigration.

Let us return then to the consideration of the case of the charged condenser which is dis-

charged by connecting its plates by a wire. The instant the plates of the condenser are joined by the wire a current begins in it which is a flow of electrons. These electrons come out of the condenser plate which is charged with extra electrons. Let q be the quantity of electricity represented by these electrons, then $-\dot{q}$ denotes the rate at which they are decreasing, and this is the same as the rate at which they are flowing through the wire, which is the current x in that wire. But if C is the capacity of the condenser and v the voltage or potential difference of the plates, then $Cv = q$ and $-\dot{q} = x$ where $-\dot{q}$ denotes the time rate of decrease of the condenser charge.

But we have seen that when the current is changing the product $L\dot{x}$ denotes the effective electromotive force or voltage corresponding to that change. Therefore we must have $L\dot{x} = v$ and combining this with the previous equation we have a relation between the current x and its rate of rate of change expressed by the equation

$$-LC\ddot{x} = x \text{ or } \ddot{x} + \frac{1}{LC}x = 0$$

where \ddot{x} denotes the rate of rate of change of x .

It has also been pointed out that when a charged condenser is discharging through a wire of very small or negligible resistance the discharge is oscillatory, that is, consists in a flow of electricity or movement of electrons backwards and forwards in the wire.

It is important to obtain an expression for the number of these oscillations per second in terms of the quantities L and C .

Whenever we meet with a mathematical expression or equation of the type $\ddot{x} + Ax = 0$ it always means the x is something which fluctuates in a manner similar to the motion of the bob of a very long pendulum, or which executes a simple harmonic motion like the prong of a tuning fork.

We must therefore obtain a mathematical expression for the time of vibration of a simple pendulum consisting of a small bob of mass m hung at the end of a slender rod or wire of length l .

When such a mass swings or vibrates about a point like a pendulum the product of the mass m and the square of the length l of the rod or ml^2 is called the *moment of inertia* of the arrangement.

If the pendulum at any moment during its swing is deflected from the vertical through

a small angle θ , then the rate at which this angle is changing with time, denoted by $\dot{\theta}$, is called the *angular velocity*. The product of the moment of inertia and angular velocity or $ml^2\dot{\theta}$ is called the *angular momentum*. The rate at which the angular momentum is changing, denoted by $ml^2\ddot{\theta}$, is a measure of the *torque* or couple causing or retarding rotation.

But we can obtain another expression for this torque or couple as follows:—The couple causing oscillation is the product of the length of the pendulum l and the resolved part of the weight of the bob at right angles to the length, viz., $mg \sin \theta$, where g is the acceleration produced by gravity. If, however, the angle of displacement is small, then in place of $\sin \theta$ we can write θ , and the torque is $mg l \theta$. Equating the two expressions for this torque, viz.:—

$$ml^2\ddot{\theta} = mg l \theta$$

we have $\ddot{\theta} = \frac{g}{l} \theta$

It will be seen that this expression for the angle of deflection of the vibrating pendulum at any instant is of exactly the same type as that for the current in the case of the dis-

charging condensers, viz., $\ddot{x} = \frac{1}{LC} x$, only for the pendulum the quotient g/l takes the place of $1/LC$ for the condenser.

We can now obtain an expression for the time of vibration as follows: When the pendulum is at the extremity of its swing, it is for the moment at rest and its potential energy is measured by the product of the mean torque and the angle of extreme displacement or by $\frac{1}{2} mlg\theta^2$.

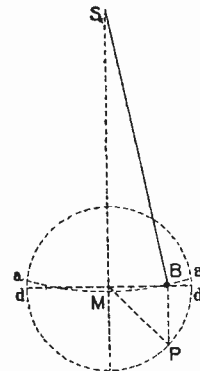

Fig. 49. Diagrammatic representation of the swing of a bob of a pendulum.

But if s is the semi arc of displacement or the distance of swing on either side, then $s = l\theta$, so that the potential energy is measured by the value of $\frac{1}{2}m\frac{g}{l}s^2$.

Again, if we describe a circle with centre at the mid point M of the swing and radius equal to the swing (see Fig. 49), and suppose that a point P in this circle moves round it with a uniform velocity equal to the velocity of the bob at the middle point of its swing, then it is easy to see that the displacement of the bob at any instant is given by the projection of this point on the diameter of this circle, and if the swing is small this diameter, dd^1 of this circle coincides nearly with the arc aa^1 of vibration. Hence, if T is the time of one complete revolution of this point P , T is also the time of one complete oscillation of the pendulum.

The velocity of the bob at the lowest point of its swing where it is a maximum is therefore expressed by $2\pi s/T$, where π is the circular constant 3.1415... or ratio of diameter of the circle to its circumference. Hence the maximum kinetic energy of the pendulum must be equal to $\frac{1}{2}m\frac{4\pi^2s^2}{T^2}$ and this must by the principle of conservation of energy be equal to the maximum potential energy at the extremity of its swing, viz., $\frac{1}{2}m\frac{g}{l}s^2$.

Therefore we have

$$\frac{4\pi^2}{T^2} = \frac{g}{l} \text{ or } T = 2\pi \sqrt{\frac{l}{g}}$$

as an expression for the time of vibration.

If we represent the reciprocal of T or the number of swings per second or per unit of time by the letter n , then this is also called the *frequency* of the oscillations, and from the above equation we have for the simple pendulum

$$n = \frac{1}{2\pi} \sqrt{\frac{g}{l}}$$

A little thought will then make it evident that since the previous discussion has shown that $1/LC$ for the condenser circuit corresponds to g/l for the pendulum, the frequency of the oscillations of a condenser of capacity C discharging through a wire of low resistance and of inductance L is given by the expression

$$n = \frac{1}{2\pi \sqrt{LC}}$$

To make use of this formula in practice we have to measure C and L in appropriate units. In wireless telegraphy and telephony condensers are used the capacity of which it is convenient to measure in *microfarads*. Also the inductances of coils of wire employed are conveniently measured in units called *millihenrys*.

To create oscillations in such a condenser circuit, one mode is to cut the discharging wire at some place and furnish the ends with polished metal balls called spark balls, placed about one or two millimetres or so apart. The other ends of the two wires are connected permanently with the condenser plates (see Fig. 50). We then connect these balls with the terminals of an electrical machine or induction coil in operation; the plates of the condenser will be charged, one as already explained, will have an excess of negative electrons forced into it, and the other will have a deficit.

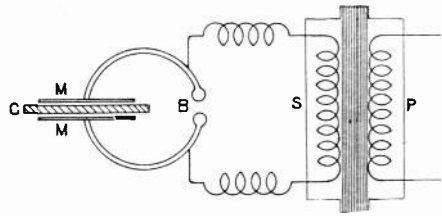

Fig. 50. Arrangement for producing electric oscillations.

- $S P$ Induction Coil.
- B Spark Balls.
- C Condenser.
- MM Metal plates of Condenser.

The small air gap between the spark balls remains a perfect insulator until the electron pressure has reached a certain voltage, depending on the distance between the balls. At this point electrons burst out of the negative ball and by their impact they ionise the air molecules or liberate from them electrons by collision. The ionized air is a conductor of electricity and hence at that instant the balls are as good as put in contact and the discharge circuit is completed. The electric oscillations of the condenser electrons then take place as already described, and as these oscillations die gradually away the air between the spark balls resumes its insulating power. The process then repeats itself and we have a series of groups of die-away oscillations called trains of damped oscillations.

In a later section we shall describe the manner in which oscillations called undamped or continuous oscillations can be created.

To give some idea of what these units mean we can say that the electrical capacity of a Leyden jar, formed with a glass bottle or jar of about a pint in capacity, might be somewhere about one-thousandth of a microfarad. The electrical capacity of the whole earth considered as a spherical conductor insulated in space is only about 800 microfarads. The capacity of a mile of submarine cable is about one-third of a microfarad.

If we make our measurements in these units the formula for the frequency of oscillation in a condenser circuit takes the following form :

$$n \left(\begin{matrix} \text{oscillations} \\ \text{per second} \end{matrix} \right) = \frac{5,000}{\sqrt{C \left(\begin{matrix} \text{in} \\ \text{microfarads} \end{matrix} \right) \times L \left(\begin{matrix} \text{in} \\ \text{millihenrys} \end{matrix} \right)}}$$

(To be continued.)

Thus, for instance, if we had a charged Leyden jar having a capacity of 1/500th of a microfarad and discharged it through a yard or two of connecting wire, which might have an inductance, say, of 1/500th millihenry, the frequency by the above formula would be 2½ millions. This means that the time of one complete oscillation current would be four ten-millionths of a second.

A circuit of this kind is called an oscillatory circuit and every such circuit has a natural time of vibration in which its electric charge oscillates when disturbed just as every pendulum of a given length has its own natural time of vibration if it is set swinging.

History Repeats Itself.

This illustration appeared in "Punch's Almanack" for 1878, dated December 14th, 1877.

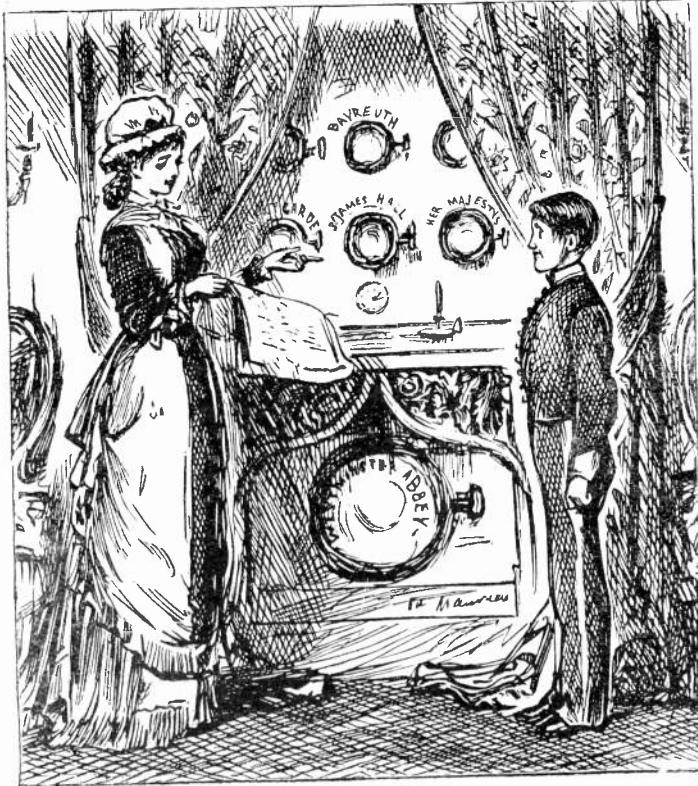

At the time the telephone was a novelty, and the illustration is an imaginative idea on the part of the artist of what might be expected of the telephone.

The picture is surprisingly applicable at the present time to wireless broadcasting, and particularly apt is the caution to "Buttons" to be sure to "close one tap before opening the other!" One might almost imagine that the artist had been privileged to peep into the future and gather his inspiration from one of the wireless cabinet sets *de luxe* now advertised!

Even the tuning devices are all there, and the suggestion of the inclusion of a clock on the panel is one which might well be followed by manufacturers who study the appearance of their products.

Musical Mistress of House ("on hospitable thoughts intent").—Now, recollect, Robert, at a Quarter to Nine turn on 'Voi che Sap-te' from Covent Garden; at Ten let in the Stringed Quartette from St. James's Hall; and at Eleven turn the last Quartette from 'Rigolotto' full o.i. But mind you close one tap before opening the other!"
Buttons.—"Yes Mum"

Wireless Club Reports

NOTE.—Under this heading the Editor will be pleased to give publication to reports of the meetings of Wireless Clubs and Societies. Such reports should be submitted without covering letter and worded as concisely as possible, the Editor reserving the right to edit and curtail the reports if necessary. The Editor will be pleased to consider for publication papers read before Societies. An Asterisk denotes affiliation with the Radio Society of Great Britain.

Correspondence with Clubs should be addressed to the Secretaries direct in every case unless otherwise stated.

Bradford Wireless Society.*

Hon. Secretary, Mr. J. Bever, 85, Emm Lane, Heaton, Bradford.

Mr. W. C. Ramshaw occupied the chair on November 17th. New members were elected, bringing the number up to 145.

Mr. Eskdale lectured on "Direction Finding." His remarks were illustrated by means of a cinema film entitled "Wonders of Wireless," which was kindly loaned by the Marconi Company.

A hearty vote of thanks was accorded to the Marconi Company.

Ilford and District Radio Society.*

Hon. Secretary, Mr. A. E. Gregory, 77, Khedive Road, Forest Gate, E.7.

On November 16th Mr. A. E. Gregory again lectured on the "Elementary Principles of the Valve."

Characteristic curves, and the method of obtaining them, were fully explained by means of diagrams.

Questions were asked and answered. Mr. Gregory was heartily congratulated on the lucid way in which he dealt with a most difficult subject.

Durham City and District Wireless Club.*

Hon. Secretary, Mr. Geo. Barnard, 3, Sowerby Street, Sacriston, Durham.

The fourteenth meeting was held on October 27th, and the fifteenth meeting on November 3rd. At the latter, Mr. F. Sargent, Chairman, lectured on "Is Planetary Communication Possible?"

On November 10th the sixteenth meeting was devoted chiefly to Morse. Mr. R. W. Rushworth being in charge.

The seventeenth meeting took place on November 17th. The attendance was very large, the districts being especially well represented. Mr. Geo. Barnard lectured on "The Thermionic Valve." He used large coloured diagrams. Every statement was proved mathematically and graphically. The lecture lasted two hours. Hearty applause was given.

Two new members were elected. By a unanimous vote Mr. H. Pratt of Crook was elected to the Vice-Presidency, and accepted.

The announcement that Mr. J. A. Dawson, M.A., Director of Education, has accepted the position of President of the Society was received with much applause.

The new receiving station is well under way.

Hamilton and District Radio Society.*

Hon. Secretary, Mr. James McKillop, 22, Dalziel Street, Hamilton.

On November 17th, Mr. James Brown lectured on the Society's detecting panel (now under construction). He commenced by drawing a diagram on the blackboard, and traced each circuit separately. At the conclusion of his lecture, the President called for a vote of thanks for Mr.

Brown and intimated that Mr. Brown would give further lectures on the high frequency and note magnifying units in the near future.

North London Wireless Association.*

Hon. Secretary, Mr. V. J. Hinkley, Northern Polytechnic, Holloway, N. 1.

At the meeting on November 15th, Mr. Hill lectured on the "Telephone System, External Working." Although the subject dealt with was not strictly "Radio" it proved of great interest to the members.

On November 20th, Mr. H. Norman Wilson lectured on the "Construction of Telephones." Mr. Wilson gave full details of the construction of his telephones, which he had made, and passed them round for inspection. The workmanship was excellent and Mr. Wilson is to be congratulated on his skill and patience. Mr. Angel afterwards explained further points in connection with magnetising telephone magnets.

Mr. Hinkley gave several very interesting demonstrations.

There is a special section for juniors up to the age of 18 years, at 5s. per annum. Ladies are invited to join the Association.

Bristol and District Wireless Association.*

Hon. Secretary, Mr. L. F. White, 10, Priory Road, Knowle, Bristol.

A meeting was held on November 3rd, in the Physics Lecture Theatre, University of Bristol, with Mr. A. E. Mitchell in the chair.

Messrs. T. W. Higgs, K. E. Wallace, W. J. Burnell, W. Foster, E. C. Jenkins and W. Brierley were elected as members of the Association. Mr. Thomas W. Brown lectured on "The Reproduction and Amplification of Gramophone Music and its relationship to Broadcasting." He demonstrated with an Edison Gem Phonograph with horns of varied materials. A Magnavox used with a gramophone by means of the special microphone attachment produced an enormous volume of sound, perfectly clear and free from distortion.

The meeting concluded with a hearty vote of thanks to the lecturer.

Wireless and Experimental Association.*

Hon. Secretary, Mr. Geo. Sutton, 18, Melford Road, S.E.22.

It was intended to give the Vice-President, Sir Fred. Hall, K.B.E., D.S.O., wireless assistance in connection with the General Election. Permission not having been received, the project had regretfully to be abandoned: but late in the afternoon of the polling day a telephone message was received that the petition was granted, and that formal permission would follow. With the Secretary's three-valve set, supplemented by batteries, amplifiers, and a loud speaker kindly loaned by Messrs. Mitchell, of Rye Lane, all the results broadcasted by 2 LO were made known.

Wireless Society of Hull and District.*

Hon. Secretary, 79, Balfour Street, Holderness Road.

The monthly lecture was delivered on November 15th, on "Calculation of Capacity." The author, Mr. Hy. Strong, being absent, the Chairman read the paper. A vote of thanks was passed to the writer and the Chairman.

Mr. G. H. Strong (President) occupied the chair, and during the evening the suggested alterations to the constitution of the Wireless Society of London were read, and those members present were in favour of the Hull Society taking such a name as The Radio Society of Great Britain (Hull and District Branch) if necessary. The matter, however, was adjourned.

Meetings of the Society are held on the second Monday and fourth Friday in each month at the headquarters of the Signal Corps in Park Street (entrance in Corporation Field), at 7.30 p.m.

Edinburgh and District Radio Society.*

Hon. Secretary, Mr. W. Winkler, 9, Ettrick Road, Edinburgh.

Mr. A. Boyd Anderson, F.B.E.A., lectured on November 15th, emphasising the need of an international language now that wireless is becoming so general. Esperanto, he said, was the simplest possible system to master, and would, if universally adopted, aid very largely in furthering business and promoting a better feeling between nations.

Mr. J. Smith, the Chairman, supported the lecturer. He advised the members of the Society to give the subject their serious attention.

Several members spoke, mostly with enthusiasm, on the subject of the many advantages of Esperanto.

Belvedere and District Radio and Scientific Society.*

Hon. Secretary, Mr. S. G. Meadows, 1, Kentish Road, Belvedere, Kent.

A paper by Mr. W. F. Ellis on "Valve Control" was given on November 17th. Special interest was aroused by the Magnatron, which is a peculiar type of diode, in which the electron emission from the filament is controlled entirely by a current-carrying solenoid surrounding the tube.

A vote of thanks was passed to Mr. Ellis.

A discussion ensued. The equipment engineer having fixed up the new Magnavox loud speaker, the meeting listened to 2 LO.

Leeds and District Amateur Wireless Society.*

Hon. Secretary, Mr. D. E. Pettigrew, 37, Mexborough Avenue, Chapeltown Road, Leeds.

At the Grammar School, Leeds, on November 3rd, a lecture was given on "Inductance Coils for all Wavelengths," by the Hon. Secretary. The subject of inductance was examined thoroughly from the practical side.

A general meeting was held on November 10th, Mr. A. F. Carter taking the chair. An exhibition of apparatus with telephony demonstrations is to be held at an early date. Mr. G. P. Kendall (Vice-President) gave a paper on "Some Gadgets of a Faddist." Many gadgets, including smoothing devices for rough anode potential, shock protectors, variometers, use of potentiometer for regenerative purposes, plugs and jacks, etc., were described.

After the discussion, Mr. H. F. Yardley proposed a vote of thanks to Mr. Kendall.

Mr. A. M. Bage (President) was elected Chairman at the next general meeting.

Liverpool Wireless Society.*

Hon. Secretary, Mr. C. L. Lyons, 76, Old Hall Street, Liverpool (Tele. 4641 Cent.).

At the Royal Institution, Colquitt Street, Liverpool, on November 16th, Mr. E. B. Grindrod in the chair, there was a record attendance. Eight new members were elected. The membership has now grown to 116.

A demonstration was given by the Hon. Treasurer, Mr. J. H. Swift, who brought to the meeting his home-made five-valve receiver.

Apparatus was lent for the evening by Messrs. Pulford Bros., Liverpool. With the assistance of Mr. A. W. Robinson excellent results were obtained. A special transmission was given by 2 ZY Manchester, and both the speech and the musical items were very loudly and clearly received. The Birmingham Broadcasting Station (2 ZP) was also picked up very clearly. Some little trouble was caused by interference from the Seaforth G.P.O. Station.

Votes of thanks were passed in favour of Mr. Swift and Mr. E. G. Bush, who very kindly acted as Acting Secretary during the Hon. Secretary's unavoidable absence. The next meeting was called for November 30th. Meetings during December will be held on the 14th and 28th.

Aberdeen and District Wireless Society.*

Joint Secretary, Mr. James S. Duthie, 148, Forest Avenue, Aberdeen.

The fifth meeting for this session was held in the Grammar School on November 10th, Dr. Fyvie presiding. Mr. W. W. Inder lectured on "An Outline of the Principles of Transmission and Reception of Wireless Telegraphy."

The detection of signals by valves was left over for consideration to a future occasion.

On the motion of Mr. Shearer a very hearty vote of thanks was accorded to Mr. Inder.

Bromley Radio and Experimental Society.*

Hon. Secretary, Mr. J. F. Croome, 26, Wendover Road, Bromley, Kent.

Mr. Allen demonstrated his five-valve receiving set on November 13th.

During the evening some dozen books were given or promised to the club library, and the Committee appeal to all members to give at least one volume so as to get together a useful and representative collection.

Clapham Park Wireless Society.*

Hon. Secretary, Mr. J. C. Elvy, 3, Fontenoy Road, Bedford Hill, S.W.12.

The eleventh meeting was held at headquarters, 67, Balham High Road, at 7.30 p.m. on November 8th, Mr. A. E. Radburn presiding.

A single valve panel made by Mr. C. A. Daniels was presented to the Society. A set of headphones also was presented by Mr. M. P. Prout, Hon. Treasurer.

The Chairman read a letter received by the Hon. Secretary from Mr. F. H. Haynes, of *The Wireless World and Radio Review*, consenting to be present at this meeting to participate in a general discussion on Wireless.

This was followed up by a direct request from the Chairman that Mr. F. H. Haynes give the lead off for the evening, which that gentleman graciously consented to do.

Having become already acquainted with each

other at the meeting a fortnight previous, those present took every advantage to keep up a running fire of questions, which Mr. F. H. Haynes readily answered in his characteristic, pleasing manner. On the whole it proved a very successful evening, Mr. F. H. Haynes having endured the attack of two hours duration.

After a hearty vote of thanks had been accorded Mr. Haynes, the Chairman switched on to another point of interest to all wireless enthusiasts, namely, the proposed inauguration of a competing Society—"The Radio Association," of 9, Southampton Buildings.

He read out the rules and objects of the Association, and after a brief discussion it was unanimously pronounced that the competitive Association should not receive recognition in any way whatsoever, the Clapham Park Wireless Society being assured that their interests were safely in the hands



An Exhibition Stand at Gloucester.

of the older established body. The Wireless Society of London (now Radio Society of Great Britain) Membership is increasing.

Walthamstow Amateur Radio Society.*

Hon. Secretary, Mr. R. H. Cooke, Ulverston Road, Walthamstow, E.17.

On November 8th, before a well-attended meeting, Mr. Allen, President, gave a fine lecture on "The Thermionic Valve and How it Works." Many diagrams were used.

On November 15th, Mr. Cooke, Secretary, gave a lecture, illustrated by diagrams, on "Radiating and Non-radiating Circuits." The lecturer very clearly demonstrated how to "howl" and how not to howl. He also drew out several non-radiating circuits, including circuits conforming to the P.M.G.'s regulations. A vote of thanks was accorded the lecturer.

London County Council Radio Society.*

Hon. Secretary, Mr. H. W. Fuller, Room 38, County Hall, Westminster Bridge, S.E.1.

Some three months ago, at the County Hall, the formation of this Society took place. It was decided to approach the Council for permission to erect an aerial; to seek affiliation with the

Wireless Society of London (now the Radio Society of Great Britain), and to endeavour to interest not only the staff, but also the Council, in the possibilities of wireless. It can now be claimed that all the Society set out to do has been done.

An aerial has been erected upon County Hall, the entire work being carried out by members of the Society. Affiliation with the Radio Society of Great Britain has been completed; the Society is now 50 strong; and finally, the Council itself has been interested enough to attend a demonstration.

On November 21st, from 5 p.m. onwards, members of the Council gathered in the large committee room of the County Hall to listen to a special concert transmitted from the London station of the British Broadcasting Company. The reception was made upon a home-made detector panel, the tuner being loaned by Messrs. Burndep, Ltd. and the loud speaker and amplifier by the Sterling Telephone Company. The Council listened with great pleasure.

The Society set out to be educational, and its great feature is that the majority of the members are beginners in radio science, learning the A.B.C. of the subject from lectures given by the Hon. Secretary, and from practical classes held by other members of the Society.

Glevum (Gloucester) Radio and Scientific Society.*

Hon. Secretary, Mr. Sidney A. Bird, 13, Central Road, Gloucester.

The stand shown in the photograph was the Society's contribution to an exhibition held by the Association of Science and Art Societies, Gloucester, with which the Glevum Society is affiliated. Telephony was transmitted by Mr. Mayall (Chairman), from St. Paul's Road, which was distinctly heard through a Brown's loud speaker, by the crowd of visitors around the stand, which the following firms assisted to make a success: Messrs. Browns, Ltd., Radio Components, Ltd., C. F. Elwell, Ltd., The Ever Ready Co., Ltd. and the Dubilier Condenser Co., Ltd. The Ever Ready Co. presented H.T. batteries for the week's demonstrations.

Cardiff and South Wales Wireless Society.*

Hon. Secretary, Mr. P. O'Sullivan, 37, Colum Road, Cardiff.

A general meeting was held at the new headquarters, The Engineers' Institute, Park Place, Cardiff, on November 9th. Mr. Norman M. Drysdale, Vice-President, took the chair.

A vote of thanks was accorded Mr. W. Evelyn Owen upon his offering a six-volt, hundred amp. accumulator as a gift to the Society.

A vote of thanks was passed to Mr. W. H. Franklin for loaning a five-valve receiving set for six months or longer.

Mr. E. Ogden lectured on "Points for every Radio Experimenter."

Many questions were put to the lecturer, and discussions arose. A hearty vote of thanks was accorded the lecturer.

Bedford Physical and Radio Society.*

The address of the Hon. Secretary of this Society is "Beechcroft," Beverley Crescent, Bedford.

Thames Valley Radio and Physical Association

Hon. Secretary, Mr. Eric A. Rogers, 17, Leinster Avenue, East Sheen, S.W.14.

On November 9th, at the Hut, Wigan Institute, a special meeting took place at which Mr. G. G. Blake gave his Presidential address with lecture, lantern slides and experiments.

General Shaw introduced Mr. Blake to a large gathering, at which over 75 members and their friends were present.

The first time that this Association was called up by radio (October 17th, 1922, by **2 OM** and **2 JM**) was referred to.

Mr. Blake personally thanked the donors of the various parts presented to the Association for their set. Further contributions will be gladly received by the Technical Committee.

A hearty vote of thanks was accorded Mr. Blake. Six new members joined after the meeting.

Hartlepoons and District Wireless Society.

Hon. Secretary, Mr. A. Brown. The Technical College, Hartlepool.

The second annual general business meeting was held in the Society's rooms, 11, Church Street, on November 7th, Mr. J. W. Patterson presiding over a record attendance. The Secretary reported on the year's progress. The Treasurer's report showed a substantial amount in hand. The following officers were elected for the ensuing year:— President, Mr. G. Wenn; Vice-Presidents, Mr. J. W. Patterson, Mr. Marris and Mr. Horsely; Secretary, Mr. A. Brown; Treasurer, Mr. R. Howey; Librarian, Mr. Forstad; Committee, Messrs. Alton, Slack, Middleton and Laing; Auditors, Messrs. Andas and Laing. It was agreed to secure new premises in the Technical College, and that the meeting might be changed to Fridays.

A social evening in the form of a whist drive and dance was held in St. Joseph's Assembly Rooms on November 8th, Mr. G. Wenn presiding. About 100 members and friends attended. The whist prizes were gracefully presented by Mrs. Jack Farmer. After supper dancing continued to the small hours of the morning.

Newport and District Radio Association.

At the fortnightly meeting on November 9th at the Memorial Hall, Queen's Hill, a paper on "Wireless Valves" was given by Mr. W. B. Edwards. A discussion followed.

An explanation of the amateur's position under the broadcasting rules was given by the Chairman (Mr. J. H. M. Wakefield), and it was felt that some action should be taken by the various Wireless Societies for protecting the interests of amateurs and experimenters.

Arrangements were made for a public wireless concert on December 7th.

Ealing and District Radio Society.

Hon. Secretary, Mr. W. F. Clark, 52, Uxbridge Road, Ealing, W.5.

The meetings of the Society are progressing favourably at the new headquarters, London Radio College, Brentford, and Mr. Rees, one of the College lecturers, lectured on November 10th on "Detectors and Amplifiers." The lecturer was obliged to postpone the second part of his lecture until a further date.

After the discussion and answering of questions a hearty vote of thanks was passed.

Northern Radio Society.

Temporary Hon. Secretary, Mr. C. V. Stead, 29, Stalebroke View, Chapeltown, Leeds.

On November 2nd, a meeting was called at Church Schools, Meanwood. Mr. Bull was elected Chairman. It was decided unanimously to form a Society. An election of officers took place. A Committee meeting was held on November 10th at Grove Mills, Meanwood, and a set of rules agreed upon subject to approval at the next general meeting. Mr. W. H. Turner was elected President, and thanked for his kind offer of the use of a room for future meetings.

The next general meeting was held on November 22nd, at Grove Mills, Meanwood. A special telephony demonstration was arranged.

The following are the officers of the Society:— President, Mr. W. H. Turner; Vice-President, Mr. A. Bull; Hon. Treasurer, Mr. H. Topp; Hon. Secretary, Mr. C. V. Stead; Hon. Technical Secretary, Mr. L. Parker; Committee, Messrs. Walsworth, Warburton, Robson, Owen, H. L. Turner, Cooper, Whetton and C. Turner.

Finchley and District Wireless Society.

Hon. Secretary, Mr. A. E. Field, 28, Holmwood Gardens, Finchley, N.3.

On November 8th and 9th a demonstration was given at a bazaar, when musical transmissions were received from **2 WP**, **5 CP**, **Writtle (2 MT)** and Marconi House.

Although there was a great deal of noise from a "fair" that was held overhead, and from a band at the other end of the hall, the transmissions were heard quite clear and loud from a Brown's loud speaker.

The Society have been fortunate to obtain the services of Mr. Read, of Messrs. Burndeput, Ltd., who was to give a lantern lecture and demonstration on November 27th. The Society met on November 13th, when Mr. Wilck lectured on "The Characteristics of the Valve," and explained the uses of the condenser and grid leak. It has been decided to hold a dance on December 11th, the arrangements for which have now been completed. The making of the Society's wireless set, which is to be on the unit system, is now well in hand.

Streatham Radio Society (Streatham Hill College.)

Hon. Secretary, Mr. S. C. Newton, A.M.I.E.E., "Compton," Pendennis Road, S.W.16.

Mr. Bevan Swift gave the first of a series of lectures specially arranged for the younger amateur on November 15th. This series of lectures promises to be very successful.

Meetings will be held on the first, third and fourth Wednesdays of each month, the second Wednesday being the lecture night.

The lecture room is in the Streatham Hill College, the Principal of which has given kindly help to the Society which is greatly appreciated by all.

Trafalgar Wireless Society.

Hon. Secretary, Mr. F. H. Stanlake, 57, Amersham Vale, New Cross, S.E.14.

At the Trafalgar Hotel, Greenwich, on November 21st, the course of lectures by the Director of Instruction, Mr. R. J. Stanley, was continued, "Valve Reception" being the subject on this occasion.

The aerial is now available for members' use.

Oldham Lyceum Wireless Society.

Hon. Secretary, Mr. Graham Halbert, 16, South Hill Street, Oldham.

A lecture was given by Mr. J. Holden, on "Recording of Wireless Signals," on November 16th. He went right back to the beginning of Wireless, and explained how a recorder could be used, and had been used with such old friends as coherers.

The whole of the lecture was illustrated by means of diagrams. The lecturer was thanked.

On November 30th Mr. A. T. Holmes, of Manchester, lectured on "Amplifier Characteristics." **Finsbury Technical College Wireless Society.**

Hon. Secretary, Mr. H. Hall, Finsbury Technical College, Leonard Street, City Road, E.C.1.

In accordance with the desire expressed by many of the students of the Finsbury Technical College the above Society has been formed.

At a general meeting held on November 10th the following members of the College staff were elected as officers of the Society:—

President, Dr. Eccles, F.R.S., M.I.E.E.; Vice-Presidents, Messrs. J. K. Catterson Smith, M.I.E.E., L. W. Phillips, A.M.I.E.E., R. A. Rinaldi and G. Parr. The following students were elected on the Committee:—Chairman, Mr. J. R. Mortlock; Secretary, Mr. H. S. M. Hall; Treasurer, Mr. B. Draper; and Messrs. J. O. Mortlock, E. W. Roper and F. Joselin.

The rules, of which the following is a brief précis, were read, discussed and passed:—

- (1) Members of the College only to be eligible for membership.
- (2) Officers and committee to be elected annually as above.
- (3) Entrance fee to be 2s. 6d. and subscription 1s. per month.
- (4) Meetings to be held on alternate Thursdays at 4.30 p.m.
- (5) Rules relating to papers read before the Society.

The meeting was then adjourned, arrangements for the next meeting being left in the hands of the Committee.

Portsmouth and District Amateur Wireless Society.

Hon. Secretary, Mr. R. G. H. Cole, 34, Bradford Road, Southsea.

An interesting talk was given by Mr. R. G. R. Cole, on November 8th, on "Valves." He explained the two-electron and three-electron valves, and dealt with the action of the grid and plate. A hearty vote of thanks was given to Mr. Cole.

The usual fortnightly business meeting was held on November 15th, when new members were elected. After the meeting, a talk was given by Mr. Gall entitled "Advice to Amateurs."

The Association is hoping to hold a Social evening and exhibition on December 6th, and already General Ferrié, of Eiffel Tower, has promised to transmit telephony especially for the concert.

Hornsey and District Wireless Society.

Hon. Secretary, Mr. H. Davy, 134, Inderwick Road, Hornsey, N.8.

Mr. H. J. Pugh in the chair at the meeting on November 13th, called upon Mr. J. R. Hunting to give his lecture on "Faults in Valve Circuits and How to Clear Them." The lecturer dealt in detail with single-valve sets and multi-valve sets.

A vote of thanks was tendered to the lecturer.

Taunton School Radio Society.

Hon. Secretary, Mr. H. W. Hamblin, Taunton School, Taunton.

Mr. I. C. Tyler occupied the chair on November 7th. Mr. Pean lectured on "The Functions of a Receiving Aerial." He illustrated the working by a number of interesting experiments.

On November 14th, with Mr. Pean in the chair, the Hon. Secretary lectured on "The Construction of a Crystal Receiver."

Stockton and District Amateur Wireless Society.

Hon. Secretary, Mr. W. F. Wood, 4, Berkely Square, Norton-on-Tees.

On November 9th, in the Malleable Workmen's Institute, Norton Road, Stockton-on-Tees, with Mr. S. B. Butler in the chair, it was reported that an efficient receiving set was expected to be installed by the next general meeting. Great progress was reported as regards the increase of membership. The meeting was followed by a concert in which many friends kindly rendered assistance.

It is proposed that the next general meeting on December 4th be followed by a whist drive.

West London Wireless and Experimental Association.

Hon. Secretary, Mr. Horace W. Cotton, 19, Bushey Road, Harlington, Middlesex.

Owing to the rapid increase in membership of the Association, the accommodation at the present headquarters is quite inadequate.

The Meeting night on Friday has not proved convenient for the majority of the members.

The Governors of the Acton and Chiswick Polytechnic, Bath Road, Chiswick, W. 4, have kindly offered the use of the large Art Room at that Institution, on Tuesday evenings, from 7 p.m. to 9.30 p.m. The offer has been accepted and the first meeting was held there on November 28th.

The Annual General Meeting is fixed for December 5th, at 7 p.m. when the election of officers for the ensuing year will take place.

Newton-in-Makerfield and District Radio Society.

Hon. Secretary, Mr. R. W. Mayhew, 220, Earle Street, Earlestown, Lancs.

The first weekly meeting was held at the Society's headquarters, Y.M.C.A., Bridge Steet, Earlestown, on November 8th. The Vice-President, Mr. R. S. Norman, gave an address on wave-formation, and explained how an electro-magnetic wave was formed. He also gave detailed accounts of Hertz's original experiments. Mr. R. Goff, a member of the Committee, followed with a short address on "The Essentials of a Simple Wireless Receiving Apparatus." Buzzer practice was conducted by Mr. H. S. Grimshaw.

Wireless Society for Pudsey and District.

Hon. Secretary, Mr. W. G. A. Daniels, 21, The Wharrels Low Town, Pudsey, Nr. Leeds.

A Public Meeting was held to discuss the formation of the Society. It was well attended.

Mr. Wild was elected Chairman; Mr. Daniels Secretary; Mr. Dockray, Treasurer. Committee of Management: Messrs. Wilman, Housencroft, Sheard, and Pearson.

A Selective Five-Valve Amplifier.*

By MAURICE CHILD.

THE amplifier which forms the subject of this paper is shown in Figs. 1 and 2. I would make it clear before I describe the instrument that there is no novelty as regards the principle upon which it works, but I think it possesses some features which are not usually found combined in one instrument, if at all, and I think that, inasmuch as an amplifier built on

The switch which controls these condenser connections is a multiple one and changes both inductances with one movement to condensers 1 and 3 or 2 and 4.

This arrangement is particularly convenient for reception from two stations whose wavelengths differ by a few metres and so avoids continual re-tuning.

As an example: when the time comes for the sermon from one broadcasting station I can switch on the hymn of the other, *i.e.*, if the latter is preferred to the former, and the wavelength is different. I must confess, however, that this was not in my mind when I constructed the instrument.

Continuing by the diagram, the plate inductance of No. 2 valve is coupled to the detector valve No. 3 through another condenser of 0.0003 mfd. and the grid of this valve is connected to the positive of the L.T. battery through a resistance of 500,000 ohms.

The grid leaks are purposely of different values for the following reason. The detector valve rectifies by virtue of a certain amount of grid current flowing when the grid is impulsed in a positive sense. With two high frequency amplification stages in front, these currents are likely to be in general fairly strong and therefore the accumulating negative pulses may easily reach a value which may limit the rectification somewhat, and even set up oscillations when undesired. By obtaining an appreciable steady current flowing in the grid circuit, a useful damping is obtained. I have found that in the case of this amplifier with wavelength ranges of from 300 to 1,000 metres that the values given are about right.

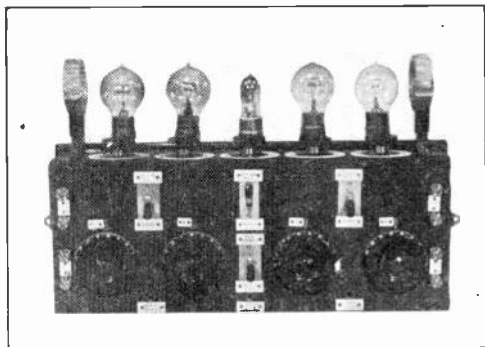

Fig. 1. The Five-Valve Amplifier.

these lines is suitable with certain modifications for the reception of the American amateur stations, that therefore it will be of interest to some here this evening.

The instrument has two valves for high frequency amplification with a switch for cutting out one of them if desired, one rectifier and two valves for low frequency magnification which can be independently cut in or out as occasion and circumstances warrant.

The H.F. amplifying valves are coupled by two tuned circuits of low ohmic resistance.

The diagram Fig. 3 shows the arrangement of the circuits.

Commencing from the left-hand side you will notice that the secondary of the tuner has its high potential end connected to the grid of No. 1 valve, and the low potential end to the negative of the accumulator battery.

The plate circuit of No. 1 valve includes an inductance coil which can be connected across either condenser No. 1 or No. 2 according to the position of the switch C.S.

The plate end of this inductance with its associated condenser is coupled to the grid of No. 2 valve through the condenser of 0.0003 mfd. marked C.1.

The grid of No. 2 valve is connected to the positive of the L.T. battery through a resistance of 2 megohms.

The plate circuit of No. 2 valve, as in the case of No. 1 valve, includes a second inductance which can preferably be of the same value as the first, which is placed across the condensers either 3 or 4 by C.S.2.

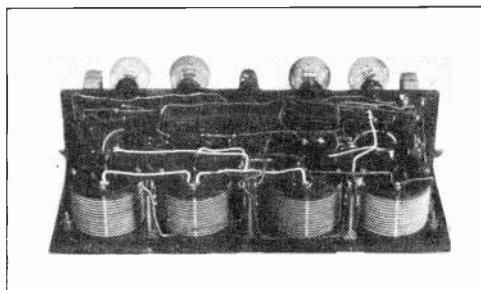

Fig. 2. The Amplifier, with case removed.

At 300 metres, however, if inductances to the order of 125,000 cms. are exceeded, the amplifier is very liable to self-oscillate, and therefore for shorter wavelengths than 300 metres I should expect to find that a value of 500,000 cms. for No. 2 valve, and 200,000 cms. for No. 3 valve would be more suitable.

The variable condensers are of 0.00035 mfd. capacity.

Turning now to the low frequency valves 4 and 5 there is nothing I think which calls for very much comment. The transformers are what is usually

* A paper read before the Radio Society of Great Britain on November 22nd, 1922

called the army pattern. For their size they are very efficient, and for two stages of magnification with no more than 60 volts, good for speech—but cannot be recommended for dealing with strong currents with consequent higher voltages.

The outside secondary of No. 1 transformer, the inside secondary of No. 2 transformer, and the inside primary (or telephone winding) of the step-down telephone transformer are all joined to the negative of the L.T. battery.

I find that this arrangement with the transformers placed as close as they are in this amplifier avoids low frequency "howling."

Other minor points are (a) a 2 mfd. condenser across the H.T. battery, (b) a 0.005 condenser across the primary of the No. 1 transformer, (c) separate filament rheostats, (d) terminals for giving the grids of the valves 4 and 5 either extra or less negative potential according to particular circumstances by means of a potentiometer or dry cells. Ordinarily the latter are short

of the wave emission of the former as on the circuit arrangements of the latter.

A telephony transmitter such as 2 WP or 2 LO is unsuitable for selective reception.

There is very little carrier wave relatively, and the emitted speech waves vary both as regards length and amplitude, consequently highly selective arrangements at the receiving station are unnecessary beyond a certain degree.

On the other hand, the elimination of arc "rustlings" and spark waves can be considerably expedited by the employment of extremely low resistance well-tuned loosely coupled circuits.

You will notice that I have fixed the plate circuit inductances at each end of the instrument, which is 18 ins. long, and they are wired up in such a way as to tend to neutralise each other in order to produce stability and non-oscillation. From centre to centre they are 16 ins. apart.

It is generally thought that it is a difficult matter to adjust an amplifier designed on these lines,

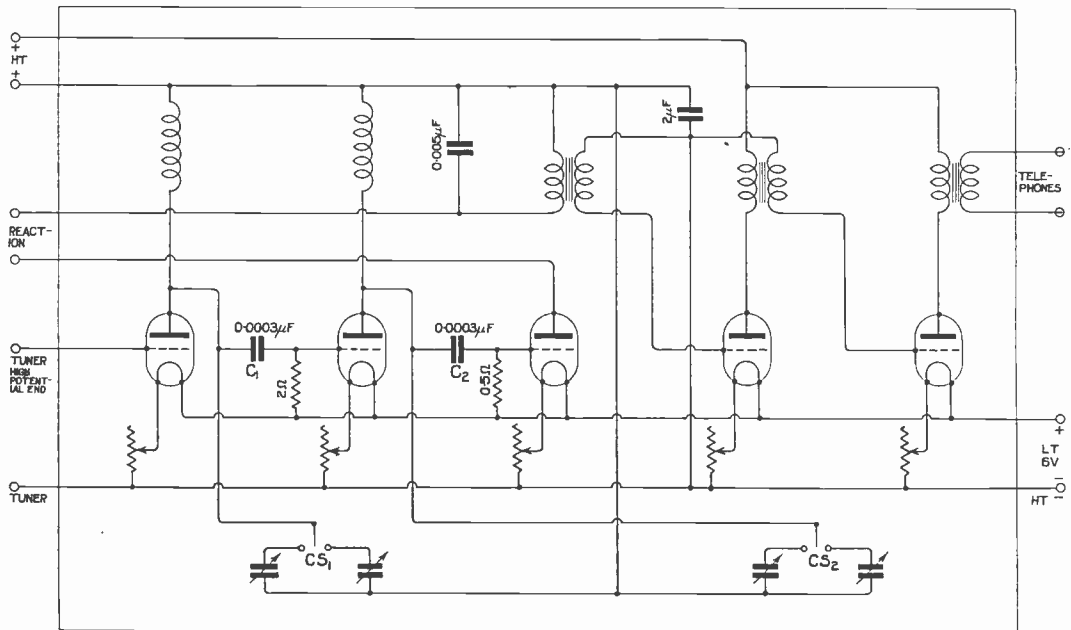

Fig. 3. Circuit Diagram, showing the method of employing the valves.

circuited. The H.F. and detector valves can have a different H.T. voltage to the L.F. valves as can be readily seen.

A diagram of the complete switching arrangements appears in Fig. 4. It will no doubt help to dissipate any latent enthusiasm some of you may be possessing for constructing an instrument on these lines.

The photograph Fig. 1 shows the external and Fig. 2 the internal view of the amplifier.

As this is not a paper on methods of obtaining selectivity, I will not enter into these except in so far as they relate to the instrument before you.

A high degree of selectivity as between transmitter and receiver depends as much on the character

but in actual practice I do not find this to be the case.

In searching I generally employ valves No. 2 and 3, with 4 and 5 added if the signals are likely to be very weak.

The moment the signals are heard and brought to maximum with condensers 3 or 4, I switch in No. 1, and as the inductance of this valve's plate circuit is generally the same value a second or two finds the position of resonance with the corresponding condenser.

For ordinary work I do not use any reaction coil, but choose the coils which experience shows produces reasonable stability.

For long waves, the instrument can be used as a

resistance or reactance coupled amplifier by inserting, in the plug sockets, attachments with the resistance coils fitted. In these cases the variable condensers are fixed at zero.

The question may arise as to why I adopted the circuits in their present compact form, since experience goes to show that the better separated the circuits are the quieter and more efficient the apparatus is.

My reply is firstly, that whilst it is true that well separated and distinct circuits are in general more effective, yet they suffer from the disadvantage of being more liable to influence, and be influenced by other apparatus that may be in operation close at hand, whereas when the circuits are arranged compactly, such influences are more easily controlled. Secondly, the space I have available for experimental apparatus is very limited. Thirdly, the particular circuits for the high frequency amplification, switching arrangements, etc., after considerable reflection seemed to offer the best all-round advantages, from the following points of view:—

Common H.T. and L.T. batteries with due

regard to economy in the use of both according to signal strength.

Good selectivity if desired without the necessity of special reaction arrangements.

Easy alteration by means of inductive resistances or non-inductive resistances to render the high frequency amplification less critical in adjustment if required.

Absence of too many adjustments, thereby rendering the "picking up" of signals relatively simple.

In conclusion I wish to tender my thanks to Messrs. McMichael, Limited, for the loan of the tuner, the Amplion and batteries, and Mr. E. H. Jenkins, of the London Telegraph Training College, Limited, for the photographs.

As the instrument is largely my own work, I trust you will overlook any serious faults of mechanical construction.

(A demonstration of the instrument was given after the lecture, a special transmission of telephony having been previously arranged.)

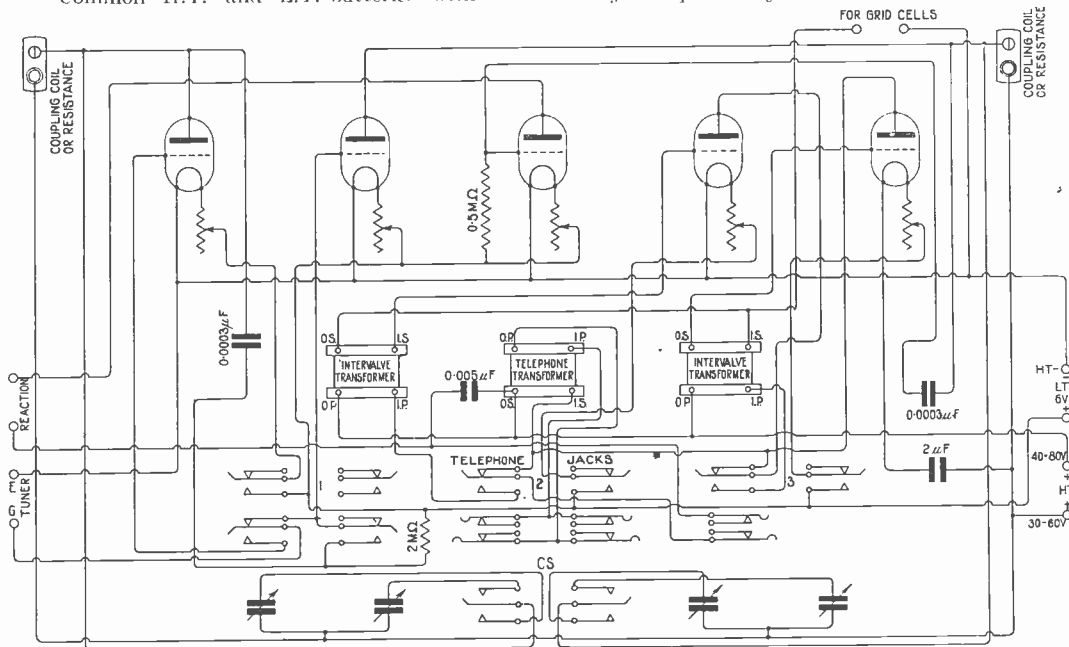

Fig. 4. Wiring Diagram, showing switching arrangements.

The next meeting of the Radio Society of Great Britain (formerly the Wireless Society of London) will be held on Wednesday, December 20th, at 6 p.m. at the Institution of Electrical Engineers, Victoria Embankment, London, W.C.2.

Notes.

Sheffield University Appointment.

Mr. H. Lloyd, B.Eng., has been appointed Demonstrator in Wireless Telegraphy at Sheffield University.

Society Formed in Swansea.

Under the title of The Swansea and District Radio Experimental Society a new body of enthusiasts has been formed.

Geneva Wireless Exhibition Next Year.

At Geneva an international wireless exhibition is to be held early next April.

Sir John Cass Institute.

At the Sir John Cass Institute a wireless class is held.

Missionaries in Communication.

American missionaries in China who have hitherto been out of touch with their headquarters are installing radio apparatus.

Wireless Co-operation at Sea.

Lecturing at the Dundee Technical College, Captain Brooke Smith, Marine Superintendent of the Meteorological Office, London, said that the essentials in a wireless report sent from a ship were firstly, the position of the ship; the barometer, corrected to sea level for a certain temperature and gravity; and the weather. It was absolutely essential to give the course and speed of the ship when broadcasting reports to other ships.

AUTOMOBILE EXPERIMENTS.

Mr. C. H. Gardner at Brooklands, with his car and apparatus aboard, with which successful transmissions were made during high speed on the track. Further experiments are to take place shortly.

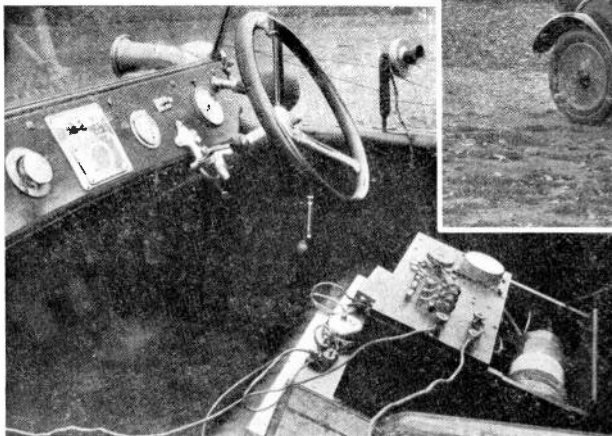

Marconi R. Valves were used for transmitting. The receiver was of the four-valve type, 1 H.F., 1 detector and 2 note mugs. On the car vibration caused a slight muffling of the speech.

Transmissions by Gramophones.

The Chairman of the Gramophone Company stated at a company meeting that the Board were satisfied that the present state of Radio science would not be likely to affect adversely the Company's business. The future might show influences upon the gramophone industry far other than prejudicial.

New Radio Concern in Belgium.

The formation in Brussels of the Société Belge Radio-Electrique is reported. We understand the share capital amounts to four million francs. The Société Générale de Belgique and other banks are interested.

"Ever Ready" Dividend.

"The Ever Ready Co." (Great Britain), Ltd., has declared an interim dividend at the rate of 7 per cent. per annum on both the preference and ordinary shares for the half-year ended September 30th, 1922.

Two Catalogues.

Two comprehensive catalogues have been issued by Messrs. R. Melhuish, Ltd., Fetter Lane, E.C. Also two new price sheets are now ready, one giving amendments to the woodworker's catalogue, and the other amendments to the metalworker's catalogue. The sheets are free to those who possess catalogues.

Northampton Polytechnic Prize Day.

Prize day at the Northampton Polytechnic Institute is December 1st. Dr. S. Z. de Ferranti will distribute the prizes at 7.30 p.m. There will be an organ recital preceding, and a conversazione for members and students following, to be continued also on the following day.

Police Installation.

Huddersfield Police Station is to have wireless apparatus installed, and members of the Force are to be instructed in its use.

Calendar of Current Events

Friday, December 8th.

LEEDS AND DISTRICT AMATEUR WIRELESS SOCIETY.

At 7 p.m. Lecture and Demonstration on "Recording Apparatus," by Mr. A. M. Bage.

BELVEDERE AND DISTRICT RADIO AND SCIENTIFIC SOCIETY.

Lecture on "Direction Finding," by Mr. G. N. Hurst.

Sunday, December 10th.

3-5 p.m. Daily Mail Concert from PCGG The Hague, on 1,050 metres.

Monday, December 11th.

9.20-10.20 p.m. Dutch Concert, PCGG, The Hague, on 1,050 metres.

FENCHLEY AND DISTRICT WIRELESS SOCIETY.

Dance.

IPSWICH AND DISTRICT WIRELESS SOCIETY.

At 8 p.m. At 55, Fonnereau Road. Lecture on "Elementary Valve Theory," by Mr. F. T. G. Townsend.

MANCHESTER WIRELESS SOCIETY.

At 7.30 p.m. At Council Chambers, Houldsworth Hall. Elementary lecture No. 2, by Mr. Y. W. P. Evans.

WIRELESS SOCIETY OF HULL AND DISTRICT.

At 7.30 p.m. At Signal Headquarters, Park Street. Paper by Mr. W. J. Nicholson on "Construction of Inductance Coils, Various Types."

Tuesday, December 12th.

Transmission of Telephony at 8 p.m., on 400 metres, by 2 MT Writtle.

Wednesday, December 13th.

STREATHAM RADIO SOCIETY.

At Streatham Hill College. Lecture and Demonstration on "Transmission and Reception of Infra Red Rays," by Mr. C. H. Roddis.

MALVERN WIRELESS SOCIETY.

Lecture on "Tuning Wireless Sets."

Thursday, December 14th.

At 9.20-10.20 p.m. Dutch Concert from The Hague, PCGG, on 1,050 metres.

HOUNSLOW AND DISTRICT WIRELESS SOCIETY.

At Headquarters, Council House, Treaty Road, Hounslow. Lecture on "Valves for the Beginner," by Mr. S. H. Nayler.

ILFORD AND DISTRICT RADIO SOCIETY.

Lecture by Mr. E. McT. Reece (of H. D. Butler & Co.).

LUTON WIRELESS SOCIETY.

At 8 p.m. At Hitchin Road Boys' School, Luton. Exchange of Apparatus.

DERBY WIRELESS CLUB.

At 7.30 p.m. At "The Court," Alvaston. Informal Meeting.

HACKNEY AND DISTRICT RADIO SOCIETY. Informal Meeting.

Friday, December 15th.

BRADFORD WIRELESS SOCIETY.

At 5, Randallwell Street, Bradford. Lecture by Mr. S. Davies (Dewsbury).

BELVEDERE AND DISTRICT RADIO AND SCIENTIFIC SOCIETY.

Discussion on "The Difficulties Experienced by the Radio Amateur," opened by Mr. S. G. Meadows.

LEEDS AND DISTRICT AMATEUR WIRELESS SOCIETY

At 7 p.m. At the Grammar School. Lecture by the Secretary, Mr. D. E. Pettigrew, on "Resistance, Inductance and Capacity in A.C. Circuits."

DURHAM CITY AND DISTRICT WIRELESS CLUB.

At 7.30 p.m. At the Y.M.C.A., Claypath. Lecture on "Wireless Telephony Transmitters Using Valves," by Mr. Geo. Barnard.

NORTH-EAST COAST INSTITUTION OF ENGINEERS AND SHIPBUILDERS.

At 7.30 p.m. In the Lecture Theatre of the Literary and Philosophical Society, Newcastle-on-Tyne. Lecture on "Wireless Broadcasting and its Possibilities," by Mr. A. P. M. Fleming.

BROADCASTING PROGRAMMES.

Until further notice the following times will be observed for daily broadcast programmes:—

LONDON: 6—6.30 p.m., News. 8—9 p.m., Music.

9—9.30 p.m., News. 9.30—10 p.m., Music.

Wavelength 360 metres.

MANCHESTER: 6—10 p.m., News and Music.

Wavelength 385 metres.

BIRMINGHAM: 7—10 p.m., News and Music.

Wavelength 425 metres.

Slight variations may occur and special transmissions take place from time to time.

BOOKS RECEIVED.

AN INTRODUCTION TO RADIO. Vols. I and II. (New York: Wireless Press, Inc., 326, Broadway. Diagrams, 96 pp. (each). Price \$1, two vols., in cardboard case, 5½ × 3½.)

Cardiff Engineering Exhibition.

Mr. E. Ogden delivered an address on "Wireless Telephony" at a conference of engineers at the Engineers' Institute, Cardiff, during the Engineering Exhibition which has just taken place. The lecturer said that wireless was a matter of vibrations first and last, and wireless apparatus was constructed on the theory that every structure, had its vibratory motion. During the discussion Capt. T. Crompton, South Wales Post Office Superintendent engineer, referring to the regulations which had been made for amateurs, said a means had been devised of tracking down anyone who broke the regulations.

Proposed Society at Haslemere.

Mr. G. D. Frost, Fernden School, Haslemere, asks that communications in connection with a proposed Radio Society at Haslemere should be addressed to him.

A Berkhamsted Society Resolution.

We have been asked by the Secretary of the Berkhamsted Wireless Society to draw attention to the following resolution which was passed at a recent meeting:—

"That this representative meeting of the Society views with the gravest apprehension the inclusion of condition No. 2 on the Broadcast Licence, holding that it establishes a monopoly of the worst type; that it is a menace to both the industrial and the scientific sides of wireless, and that it is a gross and unconstitutional interference with the liberty of the subject."

Radio Society of Great Britain.

(Formerly Wireless Society of London).

Report of Proceedings of the Fifty-First General Meeting held Nov. 22nd.

The fifty-first general meeting of the Radio Society of Great Britain (formerly the Wireless Society of London) was held on Wednesday, November 22nd, at 6 p.m., at the Institution of Electrical Engineers, London.

After the minutes of the previous meeting had been read and confirmed, the **President**, after referring to the list of 47 new members to be ballotted for and 20 newly affiliated Societies, said:—

Ladies and Gentlemen, this is a special general meeting. I suppose, using the ordinary company term, it would be called an extraordinary general meeting, and before we proceed to the lectures for the evening we have some resolutions to put before you which concern the Society only—the members and associate members of the Society. The point is that we propose to change our name to the Radio Society of Great Britain, and I will ask Sir Charles Bright to put this forward.

Sir Charles Bright.

I have pleasure in being present at this meeting and am glad of the opportunity of giving my consent to the proposal to change the name of the Society. In the first place, as some of you perhaps know, His Royal Highness the Prince of Wales, when he expressed his willingness to become a Patron of the Society, said he understood that the name of the Society was to be changed to the Radio Society of Great Britain. Therefore my proposal is a definite resolution that the Wireless Society of London be in future known as the Radio Society of Great Britain. We have not yet got to the stage of calling ourselves The Radio Society of the British Empire, but no doubt the intention is that in time we should be represented in all parts of the Empire.

I want to say just a word or two about the history of the two names applied to the science and how they sprang up. The first name, the official name, was Radio. There was an International Radio Telegraphic Convention in the year 1905. Then there was a Radio Telegraphic Enquiry in the House of Commons in 1907, to enquire into whether Great Britain should join the International Radio Telegraphy Convention. Radio is the international name for a number of reasons. One reason is that the word "wireless" involves a word of more than one sense, and another good reason is that in the United States, where wireless is being developed more than in any other country, wireless is always talked about as "radiotelegraphy."

This change however, is sure to meet with opposition to some extent. It was perfectly natural that "wireless" telegraphy should be spoken of in a business way in the early days. The moment that Senatore Marconi (Mr. Marconi, as he was then) achieved those signals across the Atlantic the term "wireless" was used in contradistinction to cable telegraphy, to show that this could be done without wire at all. Now that radiotelegraphy is going to become so universally used

as a result of broadcasting, the simultaneous communication between all parts of the Empire, is going to be enormously developed.

If "Radio" is to be our future name we should adopt the word "Radio" in everything, even although the last official committee would seem to be taking a retrograde step in calling itself The Wireless Telegraphy Committee.

Mr. E. H. Shaughnessy.

I have very much pleasure in seconding that the proposed alteration to the name and constitution of the Society should be adopted. With regard to the term "radio," Sir Charles Bright has fully explained the reason, or a good reason, why we should change the name. With respect to the latest Commission being called the Wireless Telegraphy Commission, it may be a retrograde step, but "wireless" is a popular term, and it will take time to kill. Moreover, the term "wireless," as applied to the Commission, was adopted some time back. In January of this year, at the Conference of Wireless Clubs and Societies, I suggested that the various bodies should no longer call themselves clubs. I made a remark about the "Harmonic Club," and suggested that some individuals sometimes only called themselves a club simply to draw attention to the harmonics from the various arc stations of the Post Office. I am very glad to see that my suggestion on that occasion has fallen on fruitful soil. I further suggested that if they called themselves Radio Societies all over the country it would pave the way to having a British Radio Society. I see that that is also taking effect. I do not suppose anybody paid attention to what I said then, any more than you will now, but anyhow I am trying to get some credit out of it. The suggestion of your Committee that the Society should now be called the Radio Society of Great Britain is, I think, a very good one. The International or Inter-Allied Technical Conference last year in Paris were agreed that in the matter of nomenclature we should adopt the terms radiotelegraphy and radiotelephony rather than wireless, the advantage being that the terms are easily translated into French and other languages, and have been adopted by the Americans also.

There are other points to which a little attention might be given, and one is that the scope of the Radio Society of Great Britain should be widened; that we should make room within our very large arms for those amateurs who are only beginning to be interested in the study of radiotelegraphy or radiotelephony, the suggestion that we have a new grade, a grade of Associates. By opening our arms in this way we hope to assist a very large number of people who will now take up ordinary broadcast receiving sets which are made and sold to them, and of which for some time they will be content to only turn the handles and get good signals or broadcast music.

There is not the slightest doubt about it that anybody who buys a broadcast receiving set

will get good results. But he will get more than that, he will get an interest in radiotelephony—he will want to know more about it. He will first of all buy a crystal set, then perhaps a note magnifier, and for a time he will be entirely satisfied with the signals received. After a while he will become dissatisfied with the people who make these things. He will discover that these manufacturers are no good at all. There are quite a large number of them here, that is why I am saying it. He will turn round and say this is no good to me, I must have an experimenter's licence.

We hope, as the Radio Society of Great Britain, to bring these people here to this hall, to fill the halls of our branches and affiliated societies by getting them interested in the subject. We shall educate them, and give them, if necessary, a series of lectures which will gradually lead them into the path of rectitude in respect to non-interfering properties. Our own amateurs are just as bad in that way, I am sorry to say, and one has only to sit and listen now to find out how bad things really are.

But we do hope and trust that the old members—those who know all about the subject—will, by their good example, show these people that we are really an orderly crowd, and are not hooligans, although we are reputed to be such. We do want, nevertheless, to gather in the new comers and keep them with us, and a very large percentage of them we want to become in due course full members. I think, also, that everybody who has an experimental licence ought to be a member of some Society, either of some London or provincial Society, because if he is, he will get duly roasted if he misbehaves himself, and he will learn to appreciate that he is not the only person with a receiving set. At the present time you may be quite sure that the hundreds of thousands of people who buy sets for broadcast reception will go for you experimenters when they find their reception is interfered with, and you are making a warm place for yourselves by admitting them. Nevertheless, it is a right, proper and bold move, and I hope that this meeting will see its way clear to support the Committee and adopt the proposed changes which have been put before you.

The President.

Ladies and Gentlemen, it has been proposed and seconded that our name in future shall be the Radio Society of Great Britain, and that we shall admit Associates to the Society.

(The resolutions were then put to the meeting and carried without dissent.)

Mr. I. Davidson.

I do not know whether it is permissible to make any comments at this stage, after the proposing and seconding of that resolution. If I am in order in saying a few words, I will be grateful.

The President.

Please do so.

Mr. I. Davidson.

The illness that we are all suffering from of listening-in has become very, very contagious, to the benefit of a great number of men who have to make excuses for not going out at night, I am told. But we have, I believe, a far greater task in front of us. Although I have only been a member just as long as it has taken for the ink to dry, I have watched the Society for many years, and have been impressed from the outside point of

view altogether. I feel that to-night you are taking a great step forward to broadcast the name of this Society all over the world, and I would like to throw out a suggestion. This Society has a work in front of it, in inciting men all over this country to give their brains and ambition to inventions which are going to keep the name of this country at the top of the tree so far as radio work is concerned. I suggest that this Society gives a medal every year, to be known by some name which can be coined for it. That medal need not necessarily be of gold studded with diamonds, but it can be the Radio Medal, and I venture to suggest that that medal will become one of the most coveted possessions of wireless men in this country. There are, as you know, many medals and prizes given all over the continents of Europe and America. One of the most celebrated is an ordinary bronze medal which carries with it a very great distinction, and I believe it is a medal presented to the men who find out the best things in connection with the petroleum business during the year. I do not wish to put this forward as a resolution. I feel that it is a matter which should be considered by the Committee and members of this Society.

The President.

I thank you very much for the suggestion, which shall certainly receive very careful attention.

We have here a gentleman from the United States, a member of this Society, Mr. Sleeper, well known in the United States for his connection with radiotelegraphy. I will ask if he would like to make any remarks.

Mr. M. B. Sleeper.

There is just one little matter that I would like to feel that I have brought up, and that is a correction of the idea that radio men here seem to have concerning broadcasting in the United States. Broadcasting was being discussed here when I was over last summer, and I do not think the discussion is over yet. I have been told by some of your men that the delay here is for the purpose of avoiding the chaos which has existed in the United States. I have been here for about ten days and I really do not know much more about radio conditions in England, at least so far as what can be done, than I did when I got here. I have found out much about the things which cannot be done here.

To give you an idea of what radio broadcasting is in the United States I may say that New York City, which, as you can imagine, is the centre not only of the broadcasting interest but of the manufacture of the bulk of the apparatus sold in the States. There are several thousand amateur transmitters in a radius of 25 miles of New York City.

We have at least half-a-dozen broadcasting stations of what we call high power. (We have no broadcasting stations of more than $\frac{1}{2}$ kW.)

The broadcasting stations open up when the stores do at 9 o'clock, and operate every hour, so as to give demonstrations in the stores round the country until the evening at 7 o'clock when the transmissions are continuous until 12 p.m. With an ordinary regenerative receiver and a two-step low frequency amplifier at least a dozen different stations giving different kinds of programmes

can be heard separately without interference from any other station. More than that, if a man wants to entertain friends with popular music or vaudeville performances, he tunes to 360 metres. If his taste is somewhat more elevated, he changes to 400 metres and has classical music, lectures, and various things of an educational nature.

I had a letter, just before I came away, from a man in Texas who, using a regenerative receiver and two-stage low frequency amplifier, heard in one evening without interference 37 different stations in 25 different cities, from the Pacific coast to New York City. You can imagine that when it is possible to do things like that (and it is nothing exceptional) we have not really got the chaos that is talked about over here in England.

There is another thing which may interest you,

especially in view of the fact that broadcasting here is supported largely by royalties paid by holders of broadcast receiving sets. We were selling enormous quantities of these complete sets, but now a return of sales shows that for every dollar's worth in complete sets ten dollars worth of parts are sold. In other words, our figures go to show that since the public became familiar with the operation of radio equipment they are either thoroughly interested, and have turned radio experimenters, or else they have tired of just the broadcasting itself and dropped radio altogether. My impression of the English mind is that it is much more receptive to experimental work than the American mind, and development will surely come in this direction just as it has in the States.

(To be concluded.)

New Records in Transatlantic Reception.

A REMARKABLE ACHIEVEMENT BY BRITISH RADIO AMATEURS.

By PHILIP R. COURSEY, B.Sc., F.Inst.P., A.M.I.E.E.

DURING the last few days reports have reached us of the reception in this country of telephony from American broadcasting stations. These receptions do not represent merely an isolated reception by one amateur only, but several simultaneous receptions in different parts of the country. The transmission conditions across the Atlantic during the week-end, November 26th to 27th, must have been exceptionally good for such complete reception as is indicated in one of the reports in particular to have been effected. This good transmission is also emphasised by the number of American amateur stations which were also fished up during the same period. Some particulars of these will be found set out below, under the report of the receptions of the preliminary tests recently conducted by the American Radio Relay League.

A summary of the reported receptions of American broadcasting stations follows:—

CHAS. M. DENNY (Babington, Cheshire), using a single-valve receiver:

November 23rd. 0555 G.M.T., heard very clear telephony on 360-370 metres for a period of about half an hour, apparently of American origin.

November 24th. 0100 to 0140 G.M.T. Signals from apparently the same station as above were again intercepted. These included three consecutive items of a musical programme: A humorous item by a comedian; a long orchestral selection; a dialogue between a comedian and a "coloured" gentleman.

Transmission continued until 0630 of weaker strength. During this transmission another one sending a musical programme was faintly audible on a slightly shorter wavelength.

J. H. P. RIDLEY (South Norwood), using two H.F. valves, followed by a detector and one L.F. valve:

November 26th, from 0105 to 0331 G.M.T. Signals were heard from "WJZ New York Broadcasting Station." [NOTE: Newark,

the location of WJZ, has probably been mis-read as New York.—Ed.]. The entire programme between these hours was stated to have been heard and understood. Between 0300 and 0315 the strength of the signals increased very considerably, and they were eventually read 12 feet from the telephones.

E. H. WILDING (Wigan, Lancs), using a detector valve with three L.F. valves:

November 27th, between 0130 and 0300 G.M.T., signals were heard from WJZ New Jersey. During the programme the following items were intercepted:—

Organ recitals including notes on the life-history of several well-known composers, followed by extracts of their works on an organ.

By far the most complete report has been received from:—

R. E. WILLIAMS (Holyhead), using a detector valve with 2 L.F. valves, and coils temporarily and roughly joined up for a test:

November 26th. 2340 G.M.T. to November 27th, 0324 G.M.T., a continuous programme from WJZ was intercepted. The following is an abbreviated summary of the main items of the programme which were reported:—

2340 (Nov. 26th) Speech just audible.

0015 (Nov. 27th) Speech, apparently historical. (G.M.T.)

"Napoleon was a great warrior . . ." etc., followed by speech by a lady which was badly jammed.

Parts of a sermon were next heard, the speaker repeatedly emphasising the word "courage," in such phrases as "The Israelites passed through the Red Sea as by dry land—Courage!—and went through to the land of milk and honey—

0055 (Nov. 27th) Courage!" Sermon ended with the words "God made man, and there is nothing wrong with anything God made. Good night."

0100 - - Overture, "Poet and Peasant," by _____ Organ Co., of New York City, followed by other very good items.

0139 - - "Land of Hope and Glory."

0158 - - End of orchestral performance.

0202 - - "WJZ WJZ Please stand by."

0205 - - Soprano solo with piano accompaniment.

0209 - - Soprano solo with piano accompaniment.

0211 - - Baritone solo.

0215 - - WJZ WJZ New York City. [Probably misread from Newark. —Ed.]

0217 - - Piano solo, "Kentucky Home."

0229 - - Soprano solo, piano accompaniment.

0233 - - Soprano solo, "Until" (received exceptionally well).

0237 - - Soprano solo, piano accompaniment.

0240 - - Baritone solo, piano accompaniment.

0243 - - Baritone solo, piano accompaniment.

0247 - - Speech or recitation.

0255 to 0330 - - Clock ticks—Arlington time signals.

0303 - - Speech, apparently weather report.

0307 - - Dramatic recitation.

0324 - - "This is WJZ WJZ Corporation—We are switching off. Good night."

It should be noted in connection with the above that the call letters WJZ have been variously misread as WJB, WJD and WJG. This difference probably arises from the American pronunciation of the letter "Z" as "Zee," not as "Zed," as it is usually called in this country. There seems little doubt, however, that WJZ is the correct call in each case.

THE TRANSATLANTIC TESTS.

REPORT OF SOME RECEPTIONS OF THE PRELIMINARY TESTS.

As was announced in these columns a short time ago, preliminary tests were conducted by the American Radio Relay League between October 26th and November 4th, in connection with the Transatlantic tests which are to take place in December. These preliminary tests were intended to enable the American transmitting stations to determine definitely those of them which could transmit signals over at least 1,200 miles. Those stations which succeeded in these preliminary tests will be allotted individual transmission times in the main tests.

Several reports have been received from amateurs in this country showing that they have picked up some of the American stations during these tests. These reports may be summarised briefly as follows:—

C. L. NAYLOR (Shrewsbury).
 Date. Time. Stations Apparatus Used.
 heard.

Oct. 27th 0348 2 ZK } 2 H.F. detector and 2
 0353 2 HJ } L.F. valves.

Oct. 29th 0548 2 ZK } 2 H.F. and detector, just
 audible on 1 H.F. and
 detector.

Oct. 29th 0553 2 AJL 2HF and detector.

All above transmissions were sending "Test Test de (call letters)" for 15-minute periods. Aerial used—40 ft. long, 2 wires spaced 5ft. 6 ins. lead-in 20 ft. long, height at open end 35 ft. W. R. BURNE (Manchester).

Oct. 29th 0537 1 CX
 Also an eighth district station but call letters jammed.

J. H. D. RIDLEY (South Norwood).
 Oct. 29th 0548- 2 ZK 1 H.F., detector, and 1
 0601 L.F.

Oct. 29th 0553 2 HJ (Signals read 18 ins. from telephones.)
 Also a fifth district station, but call letters jammed.

Oct. 31st — 9 CTE Same apparatus.

B. L. STEVENSON (Manchester).
 Oct. 28th 0210 5 AD 2 H.F. detector, and
 (Doubtful) 1 L.F.

Since the conclusion of the preliminary test sundry other reports have also been received of the reception of American amateur stations, of which the following may be quoted:—
 MANCHESTER WIRELESS SOCIETY.
 Nov. 19th - 23 American amateur stations heard.
 Nov. 23rd - 22 American amateur stations heard.
 Nov. 26th - 36 American amateur stations heard.

C. M. DENNY (Cheshire).
 Nov. 23rd 0555 } Continuous pianoforte selection,
 0620 } apparently of American origin.
 Wavelength, 360-370 metres.

F. W. HIGGS and J. F. HOBBS (Bristol).
 Nov. 26th 0400 1ZE, 2AIM, 8ATU } 1 H.F., de-
 (or 8 AX), 2, QR } tector, and
 8 BFM, 1 AFB, } L.F. valves.
 2 AGC.

W. E. F. CORSHAM (London, N.W.10).
 Nov. 26th 2345 2 AWF (working to } 1 H.F., de-
 1 XM. } tector, and
 } 2 L.F.
 } valves.
 Nov. 27th 0010 2 AWF (stronger } Do.
 and steadier than }
 above).

J. H. D. RIDLEY (S. Norwood).
 Nov. 26th 1 CMK
 1 XU
 2 AWL (calling
 5 LV and 9 ZY)
 2 LM
 8 BPL (calling
 4 XY)
 8 ATF
 8 AQO (calling
 SMS)
 8 XAK (sending
 weather report)
 9 LG } 2 H.F., de-
 } tector, and
 } 1L.F. valve.

B. L. STEVENSON (Manchester).

- Nov. 26th
- 1 AZW
 - 1 BDI
 - 1 CDO
 - 1 CXX
 - 1 ZE
 - 2 AHO
 - 2 CPD
 - 2 EL
 - 3 BG
 - 4 FT
 - 7 AOO
 - 8 XE
 - Also following probable (calls slightly uncertain)
 - 2 CGU
 - 2 CO
 - 2 FP
 - 4 BIJ
 - 8 AJ
 - 8 OT

2 H.F., detector, and 1 L.F. valves.

In the early mornings of November 23rd, 24th, 26th and 27th, American broadcast stations were picked up in this country by at least three amateurs as reported elsewhere in this article.

FINAL DETAILS, CONCERNING THE RECEPTION TESTS FROM AMERICA.

The first part of the Transatlantic Communication Tests are due to commence a few days after the publication of this issue of *The Wireless World and Radio Review*. During ten nights, commencing at midnight, December 12th, the American and Canadian radio amateurs will transmit signals, which will be listened for by British, French and Dutch amateurs.

The six-hours signalling time from midnight each night will be divided up into 15-minute periods, some of which will be allocated to "free-for-all" signalling, and the remainder to individual transmissions. At the time of going to press the complete list of these transmissions, with their wavelengths, etc., has not yet been received from the American Radio Relay League, so that on receipt it will be circulated by post to all who have registered their names with the writer, as desirous of listening for these signals.

All others not specially listening for the signals are again urged not to use their sets (transmitting or receiving) during the times of the tests in order to lessen the interference. All actual listeners are again urged to avoid radiation from their aeriols, since there is already so much interference on these short wavelengths from the harmonics of high power stations that all additional sources of interference need to be eliminated.

The success already achieved in picking up the preliminary tests of the Americans (as reported elsewhere in this issue) augurs well for the success of these main tests if the transmission conditions across the Atlantic prove at all favourable.

Everyone hearing signals which appear to be of American amateur origin is requested to send full details, including all code words, etc., at once to the writer of this note, whenever possible, by telegraph or telephone, so that reports may be sent back to America as expeditiously as possible, through the medium of the special daily transmissions, which have been arranged for Carnarvon, MUU, at 0700 G.M.T., each morning.

The codes to be used in these daily reports from Carnarvon, MUU (and by the French from Sainte Assise, UFT, at 0710 G.M.T. each morning), are set out below. In the case of any reports to the writer by telegraph, the English code below should also be used.

<i>English</i> (American).	<i>French</i> .
A - - - ABLE	A - - - ANDRÉ
B - - - BOY	B - - - BERTHE
C - - - CAST	C - - - CAMILLE
D - - - DOG	D - - - DENISE
E - - - EASY	E - - - ÉMILE
F - - - FOX	F - - - FRANÇOIS
G - - - GEORGE	G - - - GEORGES
H - - - HAVE	H - - - HENRY
I - - - ITEM	I - - - IRÈNE
J - - - JUG	J - - - JEANNE
K - - - KING	K - - - KÉPI
L - - - LOVE	L - - - LOUIS
M - - - MIKE	M - - - MARIE
N - - - NAN	N - - - NOÉMI
O - - - OBOE	O - - - OCTAVE
P - - - PUP	P - - - PIERRE
Q - - - QUACK	Q - - - QUIMPER
R - - - RAM	R - - - RENÉ
S - - - SAIL	S - - - SUZANNE
T - - - TARE	T - - - THÉRÈSE
U - - - UNIT	U - - - URSULE
V - - - VICE	V - - - VICTOR
W - - - WATCH	W - - - WAGON
X - - - X-RAY	X - - - XAVIER
Y - - - YOKE	Y - - - YVONNE
Z - - - ZED	Z - - - ZOÉ

These codes will be used in reporting all call letters of stations, using the appropriate words to replace the letters, thus:—

The call letters of the station 6BKV, for example, will be sent as—

SIX BOY KING VICE

in any reports from this country or from America; and as

SIX BERTHE KÉPI VICTOR

in reports from France.

TRANSMISSIONS FROM EUROPE.

The periods for these transmissions, which will be made between December 22nd and 31st, have now been arranged. Further particulars will be published next week, and all who have notified their names and signalling records will receive by post full particulars of the times of transmission and what is to be sent on each occasion. These details will be sent out a few days before the commencement of the transmission tests.

MAGNAVOX

THE WORLD'S FINEST

LOUD SPEAKER

RADIO
brings it
MAGNAVOX
tells it.

*Broadcasting faithfully reproduced
with marvellous clarity and volume*

IMMEDIATE DELIVERY.
To be obtained from all dealers or direct from the
Manufacturers & Sole Licensees

Sterling Telephone & Electric Co., Ltd.

TELEPHONE HOUSE,

210/212, Tottenham Court Road, London, W.1
Telephone No. : 4144 Museum (7 lines) Telegrams : "Cucumis, Wesdo, London."

Works : DAGENHAM, ESSEX.

BRANCHES : NEWCASTLE-ON TYNE : 9, Clavering Place.
CARDIFF : 8, Park Place.

We guarantee that all Broadcast Radio Apparatus sold by us conforms with the conditions of the Broadcaster's Licence issued by the Postmaster General.

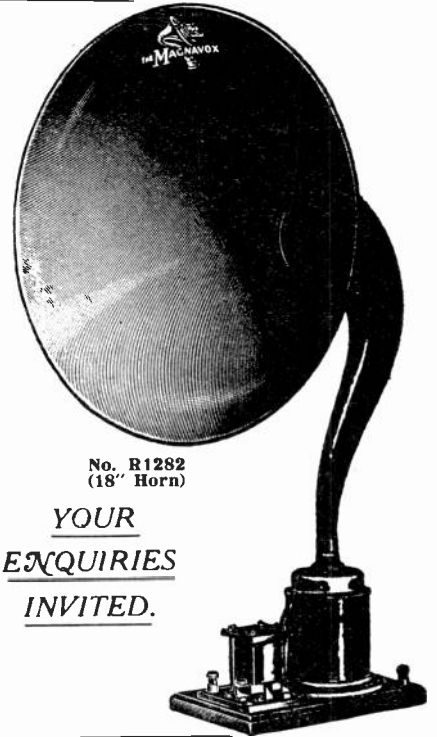

No. R1282
(18" Horn)

YOUR
ENQUIRIES
INVITED.

TOMLINSON LONDON, LIMITED.

*Demonstrations
Daily.*

3, FINSCHLEY RD., ST. JOHN'S WOOD, N.W.8
Hampstead 1844

*Demonstrations
Daily.*

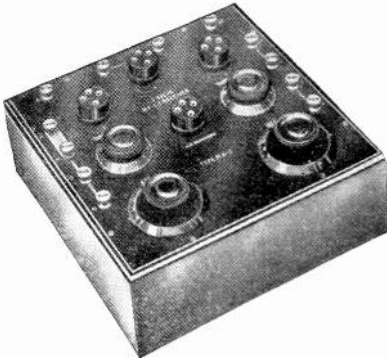

3 Valve Detector Amplifier.

- | | | |
|--|------|-----|
| "R" Valve | 12s. | 6d. |
| Filament Resistances... | 4s. | 6d. |
| Valve Holders | 1s. | 0d. |
| Interval Transformers | 20s. | 0d. |
| Aerial Insulators (Econ) | 1s. | 6d. |
| Aerial Insulators (Shell) | 1s. | 2d. |
| Reel Insulators | | 5d. |
| 2 M.F. Mansbridge
Condensers | 1s. | 0d. |
| Potentiometers, in teak
case, change-over
switch | 8s. | 6d. |
| Loud Speakers from | 47s. | 6d. |
| Insulating Wire, Aerial Wire,
Crystal Detectors, &c., in stock. | | |

Send for the New Tomlinson Illustrated Catalogue. 2d. post free.



Headphones
BRITISH MADE
4000 ohms. £1.

BRITISH and BEST

To obtain the best results from your Receiving Set it is essential to use the best 'phones



The "BROWN" Super-Sensitive Telephone Receiver Type A

OF the many recent developments in Wireless Telegraphy, the "BROWN" Type A Telephone is unquestionably one of the most valuable, inasmuch as without modifications to existing installations, the range is much increased and signals difficult to detect with the use of the usual telephonic receivers are clear and distinct when these instruments are employed.

Tests recently made have shown the "BROWN" Telephone to possess an efficiency of three times that of other telephonic headgears.

Their extreme lightness and ease of adjustment make them the most comfortable of all headphones to wear.

	PRICE: Type A (with Cords).	The Pair.
120 ohms	£2 18 0	0
Over 120 ohms to 4000 ohms	3 2 0	0
4000 ohms to 8000 ohms	3 6 0	0

Carriage Paid in U.K.

TYPE D. Recommended for Wireless Telegraphy or for ordinary telephone work in which the extreme sensitiveness of Type A is not essential. These headphones under our tests have shown an efficiency and clearness of speech greater than any other Receiver of this type.

	PRICE (with cords).	£2 8 0
120 ohms, the pair	2 12 0	0
Over 120 to 4,000 ohms, the pair		

Carriage Paid U.K.

In universal use. Supplied to British and Foreign Governments.

Illustrated Catalogue of our Headphones, Loud Speakers and Amplifier post free from:—

S. G. BROWN, Ltd.

London Offices
and Showrooms

19, MORTIMER ST., LONDON, W.1

TRADE COMMUNICATIONS ONLY TO:—
HEAD OFFICE AND WORKS: VICTORIA ROAD, NORTH ACTON, LONDON, W.3.
Telegrams—"Lidbrownix, London." Telephone—Chiswick 1469.
Sole Agent for the Argentine—Horacio D. Guerrero, Las Heras, 2486, Buenos Aires.

Questions and Answers

NOTE.—This section of the magazine is placed at the disposal of all readers who wish to receive advice and information on matters pertaining to both the technical and non-technical sides of wireless work. Readers should comply with the following rules:—(1) Each question should be numbered and written on a separate sheet on one side of the paper, and addressed "Questions and Answers," Editor, THE WIRELESS WORLD AND RADIO REVIEW, 12/13, Henrietta Street, London, W.C.2. Queries should be clear and concise. (2) Before sending in their questions readers are advised to search recent numbers to see whether the same queries have not been dealt with before. (3) Each communication sent in to be accompanied by the "Questions and Answers" coupon to be found in the advertisement columns of the issue current at the time of forwarding the questions. (4) The name and address of the querist, which is for reference and not for publication, to appear at the top of every sheet or sheets, and unless typewritten, this should be in block capitals. Queries will be answered under the initials and town of the correspondent, or, if so desired, under a "nom de plume." (5) In view of the fact that a large proportion of the circuits and apparatus described in these answers are covered by patents, readers are advised before making use of them, to satisfy themselves that they would not be infringing patents. (6) Where a reply through the post is required every question sent in must be accompanied by a postal order for the amount of 1s., or 3s. 6d. for a maximum of four questions. (7) Four questions is the maximum which may be sent in at one time.

"GRID" (Kent).—We think you will experience no difficulty from induction if a frame aerial is used, and we suggest you use a five-valve set, 2 H.F., 1 detector, and 2 L.F. valves. Circuits are given in recent issues.

"W.C." (Sheffield).—(1) We suggest you cut out the lamp and make the connection directly with the set. No trouble is likely to be experienced. (2) It is immaterial whether the windings are wound on in opposite directions or in the same direction. If two wires are wound on together, of course they will both be in the same direction. It does not matter which you call the primary or secondary in this case.

"AMATEUR" (St. Albans) asks (1) For criticism of his circuit. (2) What stations he should get. (3) How to add valves to his set.

(1) It would be much better if you provided a switch to connect the A.T.C. and A.T.I. in series

"T.D." (Walthamstow) asks for a diagram showing how to connect up four valves with switches.

The diagram given on page 883, September 30th issue, gives the principle of switching, and you will have no difficulty in applying the principles to four valves.

"B" (Taunton).—We suggest you use transformers up to 2,000 metres or less, and above this use the resistance capacity method of H.F. amplification. However, if you prefer to use the H.F. transformer method for all wavelengths because of ease in operation, good results will still be obtained. (2) The proposed method of inter-linking the switch handles is quite satisfactory, and you should experience no trouble in use. (3) See Fig. 3, page 839, September 23rd issue. (4) The station is probably working at high speed, and we cannot identify from your description the station to which you refer.

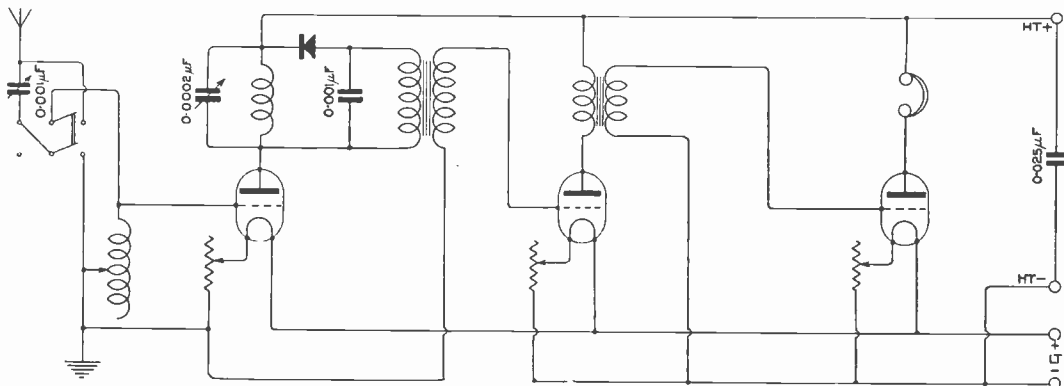

Fig. 1.

or parallel. The variable condenser in your sketch is marked 0.003. This should be 0.001 when in series. (2) You should hear broadcast stations, high power stations, and local amateur transmissions. (3) See Fig. 1.

"H.W.C." (Bedford).—(1) The moving plates are usually connected to the earth side. (2) It is general to connect the headsets in parallel, but you may get a little better results if they are joined in series. (3) The construction of a variable condenser is described on page 583 August 5th issue. You will require 25 plates altogether.

"OMNIA VINCIT" (Huddersfield) asks (1) The formula for calculating the capacity of cylindrical condensers. (2) Formula for calculating the capacity of plate condensers. (3) Gauge and covering of enclosed wire. (4) For criticism of his aerial.

(1) If the distance between the cylinders is small compared with the radius, the capacity in cms.

$$\text{per unit length is } C \text{ cms} = \frac{\frac{1}{2}K}{\log_{\epsilon} \frac{r_2}{r_1}}$$

when k_2 is the constant of the dielectric between cylinders and r_1 and r_2 are the radii of the inner and outer cylinders. (2) The capacity of a parallel plate condenser is given by $C \text{ ems.} = \frac{NK A}{4\pi D}$

where N = the number of plates K = the dielectric constant, A = the area of one plate in sq. cms., and d = the distance between the plates in cms. (3) The sample of wire submitted is No. 44 S.W.G. enamel covered. (4) We prefer the second proposed arrangement, as the aerial will then be as long and high as circumstances permit.

"P.T.H." (Highgate) asks for a design of a two-valve panel.

See Fig. 1, page 181, November 4th issue. As you only require the first two panels, the telephones should be connected across P.P. in place of the transformer. The basket coils are recommended side by side, with a $\frac{1}{4}$ " space between each, and simply take the place of the honeycomb coils shown in the figure. The panel in your possession is quite suitable if you add a few more terminals.

"J.T.L." (Anerley) refers to the reply to "C.B." (Liverpool) in November 4th issue, and asks the size of the coil in the anode circuit.

The coil to which you refer, together with the variable condenser connected across it, constituted a tuned anode, and is tuned approximately to the wavelength of the aerial circuit, therefore the coil should be about the same size as the aerial coil.

"C.S.S." (Co. Durham).—The brushes in the machine should be examined and sparking stopped. A large condenser of say, 2 mfd., should be connected across the mains, or better still, two should be joined in series and the centre connection joined to earth. If this does not reduce the noise, choke coils should be connected in the leads from the machine after the condensers.

"P.D." (Norfolk) asks several questions.

(1) and (2) We are unable to state the times of transmissions. It must be remembered that this journal goes to press several days before the date of issue. (3) "B" goes to grid.

"A.E.J." (Acton) wishes to make a short wave tuner, and asks (1) and (2) The size of former and wire and number of tappings. (3) Particulars of the condensers. (4) Particulars of the reaction coil.

(1) and (2) The A.T.I. may consist of a coil of No. 22 D.C.C. wound on a former 3" and 5" long, with 12 tappings. The C.C.I. may be a coil of No. 26 D.C.C. $2\frac{1}{2}$ " diameter and 6" long, with 6 tappings. (3) The A.T.C. should have a maximum value of 0.001 mfd. The fixed condenser across the telephone should have a value of 0.001 mfd. (4) The reaction coil may be 2" diameter and 4" long, full of No. 28 D.C.C. with 4 tappings.

"G.H." (Gothenburg) asks (1) For a design of a six-valve set using switches. (2) The number of turns to wind on a 2" former for H.F. transformer to tune from 500 to 3,000 metres. (3) How to connect a switch to provide a "tune" and "stand by" position. (4) Criticism of his loud-speaker.

(1) The diagram on page 883, September 30th issue, shows the principle of switching, and this can be applied to any number of valves. (2) You

will require coils of 250, 600 and 1,000 turns each. (3) See Fig. 2. (4) The principle of the loud speaker is correct, but you will probably find adjustments difficult to make, and we suggest you purchase one.

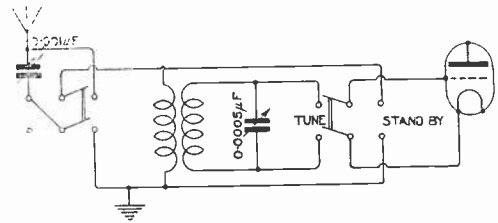

Fig. 2.

"SUPER" (Blackpool).—Yes. You may use the coil holder and duolateral coils in place of the coils shown in the article referred to.

"H.M." (Cheshire).—(1) The reaction coil has a variable coupling with the tuning inductance and the tuning of coils L3 and L4 is carried out with the tuning condenser. (2) The frame aerial could consist of 15 turns of No. 18 D.C.C. wire wound on a former 3' square. The wires should be spaced $\frac{1}{4}$ " and tappings should be taken to a switch. (3) The wavelength range of the set is approximately from 250 metres to 750 metres.

"V.E." (Lancaster).—(1) The circuit is quite suitable if you propose receiving on long wavelengths, but of course the resistance capacity method of amplification is not a good one to apply when receiving on short wavelengths. We suggest you use the tuned anode method on short wavelengths and reserve the resistance capacity method for wavelengths above, say, 2,000 metres. The suggested values of components are correct.

"SUPER" (Felixstowe) asks (1) For particulars of an iron choke. (2) Where he can obtain 12,000 ohms resistance.

(1) The choke could very well consist of an old L.F. transformer rewound with No. 38 S.S.C., or you could construct one to the following dimensions:—Core, 3" long, $\frac{1}{2}$ " diameter; iron wire, winding 10,000 turns No. 34 and S.S.C. (2) You may be able to purchase a resistance of 12,000 ohms from one of the advertisers in this journal, or you could construct one yourself, using No. 38 Eureka resistance wire. You will require about 1,500 feet of wire.

"C.E.L." (Yorks).—We think your queries are all answered in the concluding portion of the article to which you refer.

"BELL-RINGER" (Walsall).—(1) You cannot add another valve and crystal without using more apparatus, and in any case you will require more apparatus because the reaction coil is coupled to the aerial coil, which is very bad practice. (2) It would not be necessary to increase the H.T. voltage. (3) You will receive the stations named very well. We suggest you see the replies to querists whose problems are similar to your own.

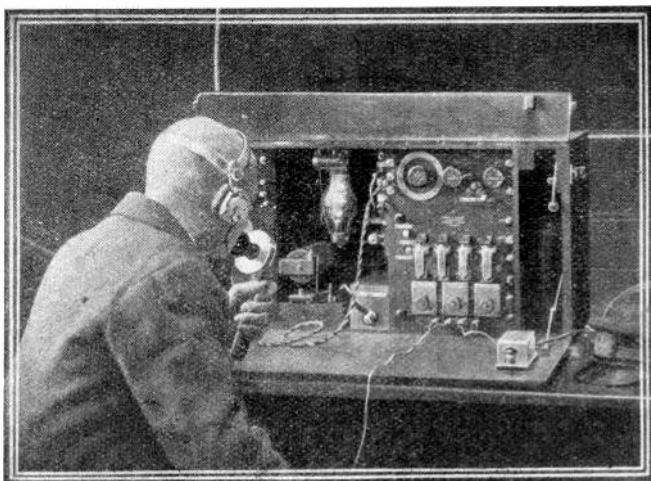

The First Commercial Wireless Telephone Service in Great Britain

is used for

Communications between the offices of the Mersey Docks & Harbour Board in Liverpool and the Bar Lightship beyond the mouth of the Mersey. The Marconi apparatus in each case is operated by the ordinary Harbour Board staff and has been in continual use since its installation over a year ago. — "Calling up" is performed by means of the
 ☉ ☉ *Marconi wireless bell* ☉ ☉

*MARCONI'S WIRELESS TELEGRAPH CO., LTD.
 MARCONI HOUSE, STRAND, LONDON, W.C.2
 Telephone: CITY 8710.*

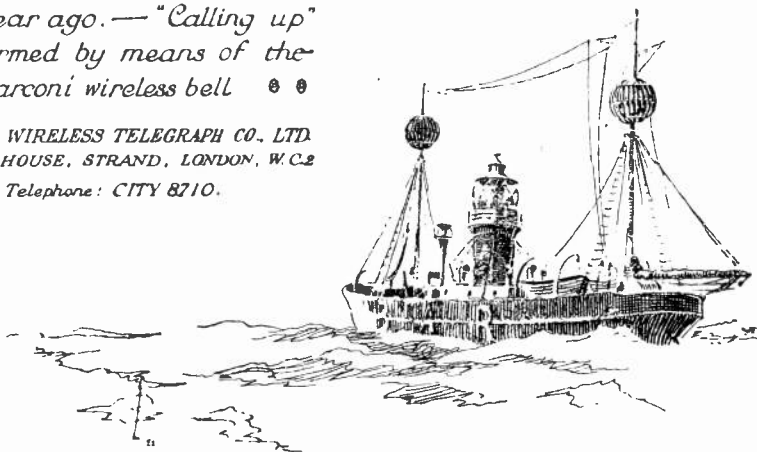



Single Valve Note Magnifier†



Two Valve Note Magnifier

“BRITWIRE” NOTE MAGNIFIERS

By using one of these Note Magnifiers the telephony received on your crystal or valve set will be tremendously increased in volume.

Each Magnifier has an input transformer, thus rendering the use of a telephone transformer unnecessary where H.R. Phones are used.

PRICE, INCLUDING B.B.C. ROYALTY.

Single Valve Note Magnifier £4 - 0 - 0

Two Valve Note Magnifier .. £7 - 0 - 0

Three Valve Note Magnifier £9 - 15 - 0

All “BRITWIRE” valve apparatus is licensed under Marconi patents for amateur use in Great Britain.

BRITISH WIRELESS SUPPLY CO., LTD.

London Offices and Showrooms :—64, Frith Street, Shaftesbury Avenue, W. 1.

HEAD OFFICE : 6, Blenheim Terrace, Leeds. Telephone : 26926.

And at—18, Eldon Square, Newcastle.

Telephone - Newcastle-on-Tyne 360 City.

33, High Street, Southampton.

Telephone - Southampton 403.

11, Church Street, West Hartlepool.

Telephone - West Hartlepool 373.

S., Corporation Street, Belfast.

BRITISH EBONITE TO GOVERNMENT SPECIFICATION FOR BRITISH WIRELESS.

MANUFACTURED BY :

THE BRITISH EBONITE CO., LTD.

HANWELL

APPLY FOR LIST “W.”

LONDON, W.7

**SPECIAL QUALITY RODS, TUBES,
and SHEETS FOR WIRELESS.
ALL USUAL SIZES KEPT IN STOCK.
Grained Ebonite is a Speciality.**

TELEGRAMS : “Ebonitical, Han, London.”
PHONE : Ealing 1689.

**WHOLESALE
ONLY.**

"VARIO" (Merthyr) asks (1) For particulars of a variometer. (2) For a diagram of connections. (1) Particulars of a variometer which is quite suitable for your purpose were given in reply to **"INTERESSE" (Brussels)**. (2) See Fig. 3. You will not need to tap the variometer.

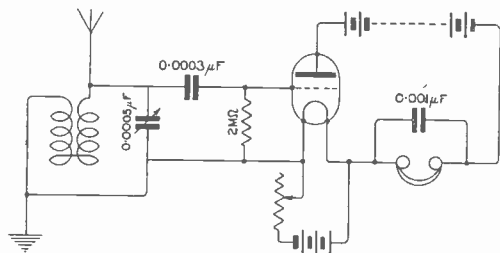

Fig. 3.

"TRAHTLOSE" (S.E.) asks (1) Wavelength range of set. (2) Correct method of tuning in signals. (3) Wavelength range of set of coils.

(1) The wavelength range is probably from 100 to 500 metres. (2) You should use one crystal combination at a time. With the switch in "stand-by" position, adjust the tuning condenser. When signals are heard, switch over to "closed circuit," and tune secondary to primary. (3) We think the wave range will be from 100 metres to 20,000 metres.

"NAUTA" (Plymouth) asks (1) What licence is required before a receiving set can be installed in a yacht. (2) Whether a crystal set will be satisfactory. (3) Most suitable aerial.

(1) We suggest you write to the Post Office, London, stating your requirements. (2) A crystal set will only give limited results, and we think for any results at all you will need valves. (3) The (b) scheme is the better arrangement, and we suggest you use 3 valves, 1 H.F., 1 detector and 1 L.F., using any of the recent three-valve circuits.

"EX R.N." (Chard) asks (1) Whether 3" x 3" of No. 20 D.C.C. will give 430 metres with 0.005 mfd. in series. (2) Would the above coil give 1,230 metres with the condenser in parallel. (3) Would a coil 2½" x 1" of No. 28 D.C.C. give 630 metres with 0.0005 mfd. in parallel. (4) Whether his calculations are correct.

(1) The inductance of the coil is 300 microhenrys. The capacity in the circuit (0.0002 mfd. in series with 0.0015 mfd.) is about 0.00018 mfd. The wavelength, therefore, is about 460 metres. (2) It will give about 1,270 metres. (3) The inductance of this coil is 230 microhenrys with 0.0005 mfd. in parallel, the wavelength is 650 metres. (4) Your figures are roughly correct—near enough for practical purposes.

"W.N.G." (Dovercourt) asks several questions about his set.

(1) We suggest you abandon the single valve reaction circuit, as interference is so often caused when oscillatory energy is transferred to the aerial circuit. (2) Suitable valves have appeared in several recent issues, and you should choose whichever appears most suitable for your purpose. (3) "B.Q." is used in acknowledging a repetition, and is an operating signal employed by the companies concerned. (4) There is no single valve

circuit which will give results without reaction equal to the results obtained with reaction.

"F.G.P." (Essex) refers to the Armstrong super-regenerative circuit described in the issue of September 2nd, and asks several questions.

(1) The arrangement you suggest will work, but when constructing a set of this description, it is better to follow the instructions exactly. (2) All coils do not require to have variable coupling with each other. (3) The correct value is 0.0005 mfd. (4) See recent replies.

"CALPO" (Gibraltar) asks (1) Whether two coils are suitable. (2) The identical values of the coils. (3) and (4) The number of tappings and capacity of variable condensers.

(1) The coils are quite suitable. (2) The induction of the coils is 7,000 microhenrys and 11,000 microhenrys. (3) and (4) We suggest you take 10 tappings from the primary coil and 6 from the secondary coil. The A.T.C. should have a maximum value of 0.001 mfd., and the secondary tuning condenser 0.0005 mfd.

"C.L.H." (Godalming) asks (1) How to connect a switch to change from H.F. transformer to reactance capacity. (2) Where to couple the reaction when making use of an intervalve set.

(1) It is the usual practice to connect the grid leak between grid and filament, and not to join the grid leak across the grid condenser as you suggest. A switching arrangement is given on page 129, October 28th issue. (2) The reaction coil should be coupled to the grid winding of the H.F. transformer coupling, the anode circuit of the first valve to the grid circuit of the second valve. Several diagrams have recently been given showing this method of coupling the reaction coil.

"OZONE" (London, W.) asks questions about the four-valve set described by P. W. Harris in this journal.

The author described a simple arrangement for coupling the reaction coil to the anode coil in the issue of November 25th, page 274.

"E.A." (Durban)—We suggest you wind a number of basket coils, the smaller coils having 60 turns and the larger 100 turns. About six will be required, and you should join them in series, taking the tappings to a switch.

"X.B.S." (Yorkshire) asks (1) Whether a crystal detector can be fitted to the broadcast receiver described in the issue of August 26th. (2) The name of a firm who sells Litzendraht wire.

(1) See Fig. 4. (2) We suggest you communicate with a firm of wire manufacturers.

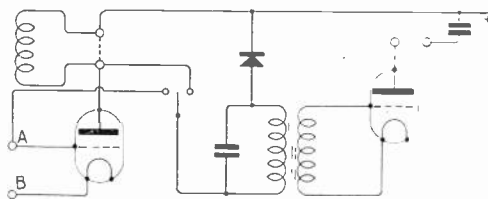

Fig. 4.

"W.S.F." (Ealing) asks (1) How to obtain a supply of filament current or plate current from

A.C. 50 cycles mains. (2) If the A.C. supply will cause disturbances.

(1) and (2) It is very difficult to utilise a 50 cycle A.C. supply for the anode and filament supply of a receiving set. The A.C. may be stepped down with a transformer for heating the filaments, and passed through rectifying valves, and a smoothing system for use as the anode supply, but the hum will be so serious that reception of signals will be practically impossible, and we do not recommend you to adopt this method.

"GATRA" (Finchley) asks (1) How to modify the reaction arrangement on his set, and asks for particulars of short wave coils. (2) Whether a reduction in signal strength naturally follows the adoption of reaction coupled to the H.F. transformer. (3) Whether a Brown telephone relay can be used to work a Morse inker.

transformer. (2) We consider a combination of 1 H.F. and 1 detector valves superior to the combination of valve and crystal to which you refer.

"C.M.K." (Staffs) asks (1) If the circuit submitted is a good one. (2) If we will modify the circuit and include switches. (3) If certain coils are suitable. (4) If with his set he could use a loud-speaker.

(1) The circuit submitted is correct. (2) We suggest you wire switches according to the diagram on page 883, September 30th issue. (3) The coils suggested will do very well. (4) You will amplify local amateur transmissions and broadcast stations sufficiently to usefully employ a loud-speaker. With reference to your final remarks, a large number of receiving sets, especially designed for use on broadcast wavelengths have recently been described in this journal.

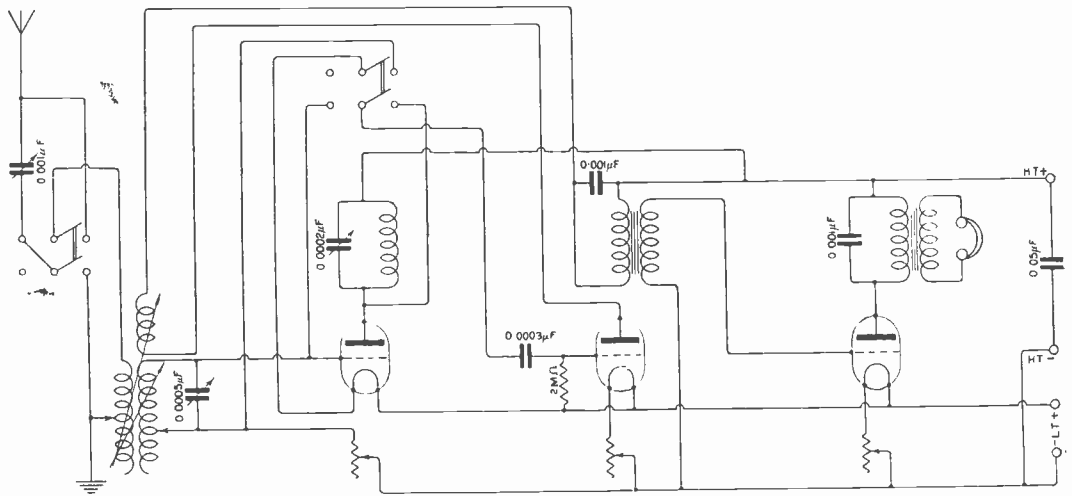

Fig. 5.

(1) We suggest you wind a former 4" diameter and 5" long full of No. 22 D.C.C., and take 10 tappings for the aerial inductance. The closed circuit coil should slide in and out of the aerial coil, and may consist of a former 3" diameter and 6" long, wound full of No. 26 D.C.C. with 6 tappings. The A.T.C. and A.T.I. should be in series when tuning short wavelengths. The reaction coil, as you propose, should be made exactly as described in the article, "Experimental Station Design," September 2nd issue, page 717. (2) No reduction in signal strength will follow the adoption of this method of coupling the reaction coil, and the advantage is oscillating energy cannot be transferred to the aerial circuit. (3) Very probably you will be able to work a morse inker in the way suggested.

"C.W.H." (Wolverhampton) asks (1) Gauge of sample of wire submitted, and whether it is suitable for wiring 120 ω. telephones. (2) For criticism of set.

(1) The wire is No. 46 enamelled copper, and is too fine for the winding of a 120 ω. telephone

"W.G.P." (Birmingham).—A suitable arrangement is shown in Fig. 5. The switch is of the double pole change-over type. When in the right-hand position, the H.F. valve is connected in circuit, and is cut out of circuit completely when in the left-hand position.

SHARE MARKET REPORT

Prices as we go to press on December 1st, are:—

Marconi Ordinary	£2 4 0
" Preference	2 1 0.
" Inter. Marine	1 7 0.
" Canadian	9 6.

Radio Corporation of America:—

Ordinary	16 7½
Preference	13 0

ORA

The Valve for perfect reception

For receiving vocal and instrumental items you must have Mullard "ORA" Valves to get the best results.

Oscillates — Rectifies — Amplifies
Specially recommended where good detection and amplification are required.

15/- each

IMPORTANT NOTICE.

The great demand for Mullard "ORA" valves and other accessories has compelled us to open much larger works.

The "ORA" Valve requires about 3·8 volts on the filament and 30 volts or over between the anode and filament for efficient results.

The MULLARD "R" Valve is now reduced in price from 22/6 to 17/6.

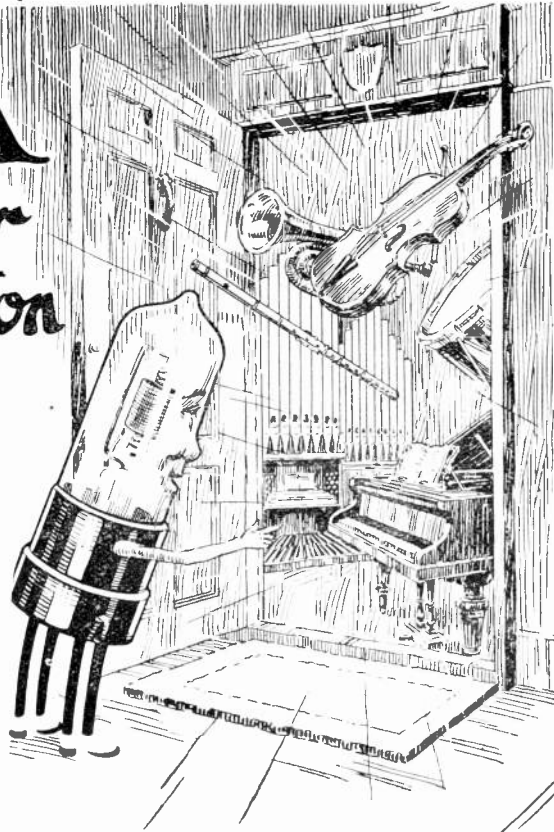

Mullard Radio Valve Co., Ltd

45, Nightingale Lane, Balham, S.W.12.

Contractors to H.M. Admiralty,
War Office, Royal Air Force &
Post Office.

Telephone: C. des: Telegrams:
Battersea ABC (5th Ed.) "Radiovalve."
1068. Bentley's Hammer Lond."



Name and Address
To the
MULLARD RADIO
Valve Co., Ltd.
45, Nightingale Lane,
Balham,
S.W.12.

Please send me post free:

- Quantity..... Description
- Telephone Head Sets
- ORA Valves
- Grid A Resistances
- Anode A or B Resistances
- B A Condensers (003 mid)
- Combined Resistance
- Valve Bases with Condensers
- Valve Sockets and Terminals
- Terminal Clips
- Name of usual Wireless dealer:

Price
35/- per set
15/- each
" "
" "
2/6 " "
7/6 " "
1/3 " "
9/- per pair

I enclose (Cheque/
Money Order, P.O.) Value
to cover the
cost.

SEND THIS TO-DAY.

THE Marconiphone

The MARCONIPHONE V.2. PRICE £25 : 0 : 0

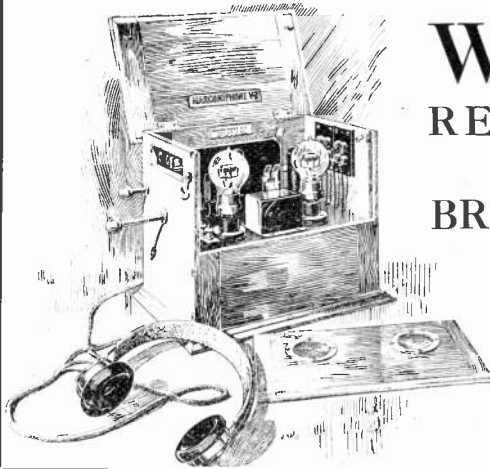

WIRELESS RECEIVING MODELS for BRITISH BROADCASTING

Incorporate unique features
which ensure perfect reception.
Full Compliance with Government
Regulations.

THE MARCONIPHONE DEPARTMENT
MARCONI'S WIRELESS TELEGRAPH CO., LTD
MARCONI HOUSE, STRAND, LONDON, W.C.2

“RADIO-WAVE” CRYSTAL BROADCAST RECEIVER.

This Broadcast Receiver conforms to the Post Office Regulations for Broadcast Receiving apparatus. There are many receivers being offered to the public which do not conform to these requirements and broadcast licence holders may later experience the annoyance of having them condemned by the Post Office Inspectors. Apart from this there are other reasons why you should not hesitate to fix your choice on the “Radio Wave” Crystal Broadcast Receiver.

- (1) You will not be confined to the reception of Broadcast. Amateur telephony and morse code messages from ships may be tuned in.
- (2) The short wave switch gives **ULTRA EFFICIENCY** on amateur wavelengths.
- (3) The twelve-point inductance switch gives 100 per cent. tuning accuracy. The instrument is therefore extremely **SENSITIVE** to the **WEAKEST OF SIGNALS**.
- (4) Only selected Hertzite crystals are used in the detector.
- (5) The detector is robust, comfortable to handle, and easy to adjust, giving every possible point of contact.
- (6) The detector cup may be easily removed—facilitating rapid replacements.
- (7) Owing to the special care taken in the construction to avoid electrical leakage this instrument should give a slightly larger signal range than the average crystal receiver.
- (8) It is a well made handsome apparatus, metal parts being highly polished and lacquered, and the cabinet work French polished mahogany.
- (9) It is sent out with full instructions, under guarantee.

Price, including cost of aerial wire, insulators, 4,000 ohms resistance headphones, with two earpieces, **£10 10.**

MADE BY:

THE MEDICAL SUPPLY ASSOCIATION, Ltd.
167/185 Gray's Inn Road, London, W.C.1. Works: London & Sheffield.

Telephones: MUSEUM 7210, 7211, 7212.





**TUBE, SHEET,
WIRE, STRIP,
ROD & CASTINGS**
IN
**PHOSPHOR BRONZE,
COPPER, BRASS, &c., &c.**

**CHARLES CLIFFORD & SON, LTD.,
BIRMINGHAM.**

WIRELESS TRAINING
Most thorough training in Wireless Telegraphy or Telephony given under ideal conditions.
Special Postal Course for Amateurs.
Prospectus Free.

WIRELESS APPARATUS
Complete stocks of all Wireless Instruments and Accessories. Prompt Deliveries. List 1½d. stamp.

**WIRELESS COLLEGE
COLWYN BAY**

SPEARS and COMPANY
FOR
TERMINALS

SCREWS, NUTS, WASHERS, PLUGS and SOCKETS, CONTACT STUDS, BUSHES, VALVE LEGS, CONDENSER VANES and TURNED and PRESSED PARTS OF EVERY DESCRIPTION.
Actual Manufacturers to TRADE ONLY

We regret we cannot supply small lots to Amateurs.
Write for Illustrated List.

**CAPSTAN REPETITION WORKS,
PARK ROAD, HOCKLEY, BIRMINGHAM**
Telephone : 3265 Central, Telegrams : "Firettes," Birmingham



SKINDERVIKEN BUTTON.
A Supersensitive Microphone.
Known all over the world and patented in every civilised country. Over 80,000 sold. ENGLISH Manufacture.
Make up your own Loud Speaker.
Transmit your GRAMOPHONE music to any room in your house.

The only practical Microphone for use in Detectophone Sets.
Price 5/- each
Special Low Resistance Receivers (for use with Skinderviken Buttons) 10/- each
Special Gramophone Attachments 1/-

Write for 16 page BOOKLET fully illustrated and containing much useful information for all interested in Electrical Sound Transmission. 6d. Post free.
Sole Proprietors:
MIKRO LTD., 274/6, Pentonville Rd., London, N.1
(Opp. King's Cross (Met.) Kly. Station).

.....

W. A. C. SMITH
236, Argyle Street,
GLASGOW,
are Sole Scottish Agents for the
Famous Burndept Receivers

.....

F. WIGGINS & SONS
Telephone :
MICA Avenue 2248
Largest Stock
in the World.
**FOR CONDENSERS
AND ALL PURPOSES.**
102, 103 & 104, Minories, London, E.1

**NORTH - EASTERN SCHOOLS OF
WIRELESS TELEGRAPHY**
Established 1911.

18, Eldon Square, Newcastle-on-Tyne
6, Blenheim Terrace, Leeds
33, High Street, Southampton

Young men between the ages of 18 and 25 are trained at these Schools in the profession of Wireless Telegraphy and Telephony. All Four Systems are taught, Marconi, Telefunken, Poulson and Valve. Special terms to partly trained students.
Splendid Openings for Trained Wireless Men.
Write or call for Illustrated Prospectus.

L.O. HERE IT IS.—M. E. C.



Crystal Receiver complete with everything in polished Cabinet. Royalty paid to B.B.C. Reg. No. 138. Carriage paid from stock. All tested and guaranteed they speak loud and clear.
Price
£3 : 15 : 0
complete.

M.E.C., Crownhill Road, Harlesden, London, N.W.10.
Willesden 3370

ACCUMULATORS HIGHEST QUALITY
LOWEST PRICES

4 Volt 40 Amp. ..	18/6	6 Volt 40 Amp. ..	26/3
4 " 60 " ..	21/6	6 " 60 " ..	32/9
4 " 80 " ..	28/2	6 " 80 " ..	37/3
4 " 100 " ..	30/-	6 " 100 " ..	43/6

In celluloid cases.
SPECIAL LINES.

6 Volt 40 Amp. ACTUAL (88 igniting amp.) in three glass cells, sealed tops and in well-made teak crate with strap handle. ELEVEN PLATES per Cell .. 49/6
24 Volt HIGH TENSION Accumulator, complete in polished teak case .. 24/6

BARGAIN OFFER, 700 ONLY.

4 Volt 30 Amp. in celluloid cases, 13/- each, postage 1/3.
2 Volt 30 Amp. in celluloid cases, 6/9 each, postage 1/-.

GOOD DISCOUNT TO TRADE

KNIFE SWITCHES

On Ebonite.
S.P. S.T. D.P. S.T.
S.P. D.T. D.P. D.T.
As illustration 2/9 each.

COIL PLUGS

2/- each

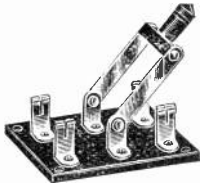

HEAD PHONES 4,000 ohms, High Quality .. 22/6
WRITE FOR LISTS.

F. YATES & SON, LTD.,

144, Church St., Kensington, London, W. 8.
Phone, Park 4276. One Minute from Notting Hill Gate.
Central London and District Railways.

16 Pages, handsome cover in three colours, gives you full information and prices on Wireless Receiving Sets complete from £3 10s. to £12 10s. Hear all the concerts, speeches, sermons, news, crop and weather reports, now being broadcasted daily. Costs you nothing after first cost. Easy to install and operate. And hundreds of other Wireless articles.
Write to-day. FREE.

**PERMANENT ONLY
CRYSTAL 7/6
DETECTOR** Post paid

Ready to attach to your set.

Greatest boon ever known to Wireless Experimenters. Always ready, no fiddling or searching for a point. Crystal always active. Largest mail order firm in Europe. **Important Notice.**—All our apparatus is guaranteed "your money back in full" if not satisfied. Write to-day.

**BRITISH RADIO
SALES CO. LTD**
STERNES BUILDINGS, GRASSE ST.,
RATERSHALL, LONDON W. 1.

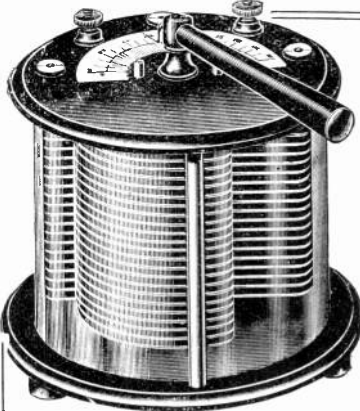

CONDENSER PARTS

Fixed and Movable Vanes, 3 1/2" x .040", price 1 6 doz. Centre Rod, 4 1/2" overall, fitted with Indicating Finger and extra large handle. Price 4 6. Screwed Rod, 7 1/2 d. per ft. Ivorine Condenser Scales, accurately marked, each 1 -



**EBONITE KNOB AND
ENGRAVED EBONITE DIAL**
D's. 2 1/2" 3 -

The
Universal Electric Supply Co. Ltd

4 BROWN STREET
ONE DOOR FROM MARKET ST
MANCHESTER

Telephone: 3409 CITY Established 1892

G.P.O. Box No. 519.

All Radio Requisites promptly supplied. Complete Valve and Crystal Sets for Broadcasting Reception. P.O. Licenced. Fully illustrated catalogue post free 6d.

HONEYCOMB COILS

Excellent Results—

Wavelength	
180	4 6
300	4 6
450	5 -
600	5 -
800	5 2
1,000	5 6
1,500	7 -
2,000	7 10



Coil Holder, High grade finish—Three-coil Type 18 - Mounted on polished base 21 -

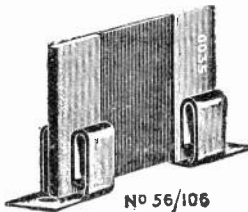

No 56/106

FIXED CONDENSERS
All capacities from .001 to .0005, complete with clips .. 3/-

KNIFE SWITCHES

Strong Copper Clips and Blades mounted on white Porcelain Base Single Pole one-way .. 2/6
Single Pole change over 4/-

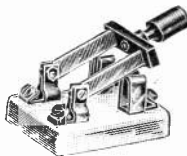

TERMINALS

Make up your own H.T. Batteries, doz. 1.6. Easily attached to Pocket Lamp Batteries.

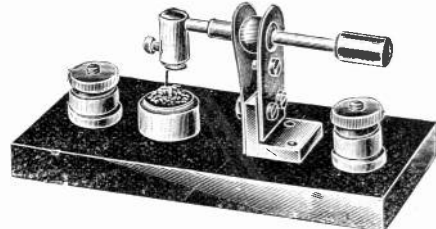

New Model Crystal Detector without Crystal .. 3/6
CRYSTALS, price per tin—Bornite 1 -; Carborundum 1 -; Copper Pyrites 1 -; Fused Silicon 1 6; Myronite Crystal, remarkable results, per piece 1 9.

EDISON BELL

MOULDED INSULATORS

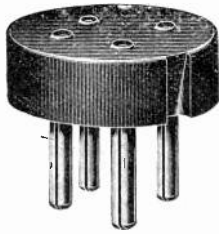

62



76



68



75

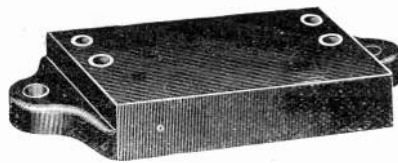

69

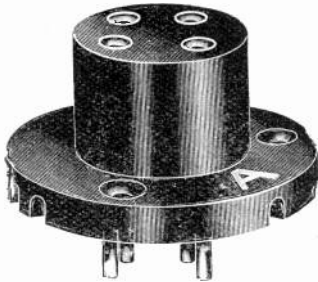

63

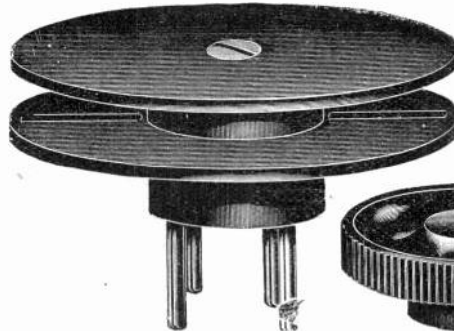

88



81

OBTAIN QUOTATIONS DIRECT FROM THE
ACTUAL MANUFACTURERS.
ANY DESIGN TO ORDER.

J. E. HOUGH Ltd. 32, Victoria St.
LONDON, S.W.1

THE BIRMINGHAM RADIO COMPANY

Carlton House, BIRMINGHAM

Two-Valve Set, fitted with engraved ebonite panel, .001 variable tuning condenser, .0003 anode and blocking condensers, grid leak (Dubilier), coils up to 3,000-metres, will carry all wavelengths for telephonic reception, filament control for each valve, mounted in polished mahogany desk cabinet. Broadcasting fees included.

PRICE £9.

Crystal Receiving Sets, complete, consisting of ebonite panel mounted in oak cabinet with lid, tuning inductance and air dielectric condenser, high grade Hertzite crystal detector, Brown's 4,000 ohms phones 100 ft. AERIAL and insulators (approved by the P.M.G., Reg. No. 207). Several Continental Stations have been received on these Sets. No intricate adjustments. For Wireless Telephony Broadcasting, it is suitable for a range of 25 miles. Immediate delivery.

PRICE £4 10s. 0d. (Carriage Paid).

Filament Resistances	3 - and 4 - each
De Forest pattern coil plugs (fitted with split brass contacts, etc.)	each 1 -
Twin ebonite coil stands	each 8 6
Three-way ebonite coil stands	each 12 -
(We are presenting De Forest coil plugs fitted to the coil stands.)	
Variable Condensers, air dielectric, fitted with knob and pointer :-	
.001	each 12 6
.0005	each 10 -
.0003	each 7 6
.00005	each 4 6
Grid Leak and Condenser, sealed pattern, fitted with lacquered terminals	each 2 -
Blocking Condensers, fitted with lacquered terminals,	each 1/9
Engraved dials 0 to 180, fitted with knob.	each 1 2

Cash with order. Postage extra.

A BROADCAST RECEIVER OF DISTINCTION

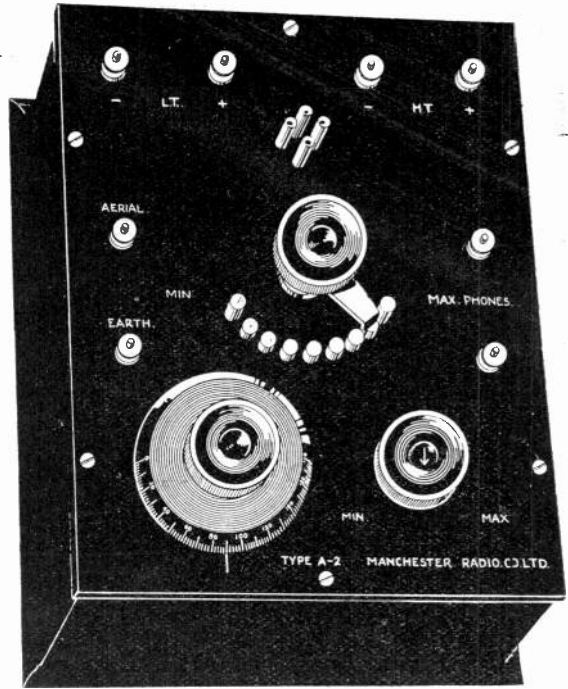

Registered design No. 693330. Post Office Registration No. 1033

Price £10 12s. 6d.

All our apparatus will be marked with the B.B.C. This set can be worked by anyone not having had any previous experience or knowledge in Wireless.

The materials used in the construction of the instrument are of the highest quality and manufactured by experienced Wireless Engineers.

Also supplied as complete receiving station including the following accessories :- 1 pair Brown's Headphones, 4000 ohms, 1 Valve Marconi or Marconi Ediswan type "R," 1 4-volt 40-amp. Clifton Accumulator, 1 50 Siemens High tension Battery, 1 Lead-in Tube, 100 feet Aerial Wire (enamelled), 6 Insulators, 1 Earthing Clip.

Price inclusive £16 10s. 0d. Carriage paid United Kingdom

DO NOT FORGET that we are the agents for Messrs. Dubilier Condenser Co.'s specialities—delivery ex stock Manchester.



The Manchester Radio Co., Ltd.

RADIO ENGINEERS,

F. H. McCREA, Managing Director.

W. R. BURNE, Directing Experimental Department.

155, OXFORD RD., MANCHESTER

(Entrance Boundary Street East)

Telephone: Central 4935

EBONITE VARIOMETERS

What you have been waiting for! Ebonite Rotor and Stator, unwound. These are non-hyrosopic, and are ideal for Telephony tuning.

Interested parties are invited to write for further particulars. If required the Ebonite Rotor can be supplied separate.

EBONITE PANELS AND SHEETS—There is no reason for you to experience any delay in your supplies. We are in position to give IMMEDIATE DELIVERY of RELIABLE QUALITIES, in large or small quantities. Enquiries will receive prompt attention.

RADIO EBONITE SUPPLIES,

4, LITTLE COLLEGE STREET
(2 min. Cannon Street Station).

LONDON, E.C.4

Phone—CENTRAL 4839.

Wholesale Only.

Series No. 3.

Western Electric

MAKERS OF OVER
HALF THE WORLD'S TELEPHONES

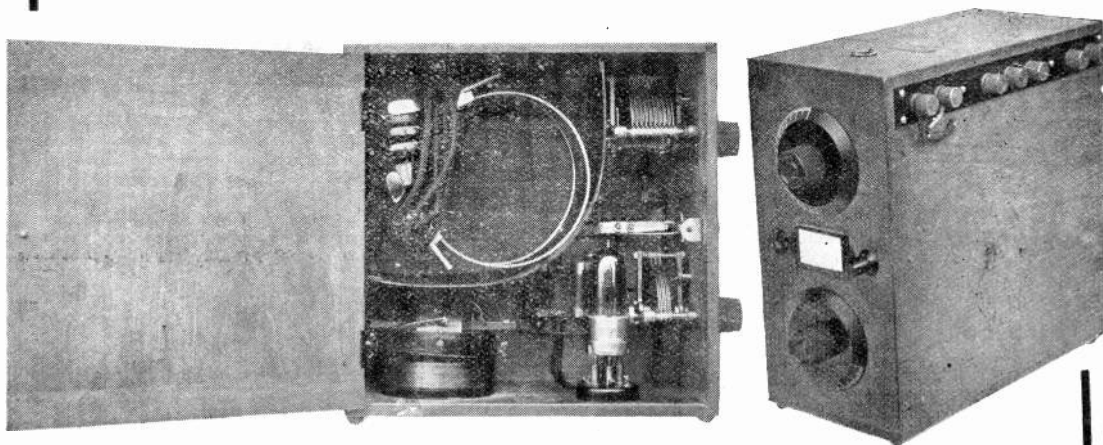

Western Electric

VALVE DETECTOR AND TUNER

is contained in a polished mahogany case and provides for the inclusion of Double Head Receivers, while a spring button is fitted on the top of the case to open the receiver compartments. The valve filaments can be seen through a specially designed mica window, and ventilation discs are provided to fully ventilate the interior of the case. At one end of the case a small card is fitted which gives particulars of various wavelengths together with the respective condenser settings, and above and below are the Variable Condenser Handles. The set is simplified by the use of only one handle for fine tuning, and the filament key is conveniently placed on the right-hand side of the wavelength index. The valves used are specially made to Western Electric specification, and the whole set is built to give the greatest possible efficiency.

Western Electric Company Limited.

62, Finsbury Pavement, London, E.C.2
Telephone—London Wall 7608

WORKS:—

North Woolwich, London, E.16
Telephone—East 3840 (10 lines)

Also at BEXLEYHEATH, KENT, and NEW SOUTHGATE, N.11

Birmingham—Grenville Buildings, 12, Cherry St.
Leeds—Standard Buildings, City Square.
Cardiff—Motor House Chambers, 1, Wood St.

Manchester—Northern Assurance Buildings.
Newcastle—20 Saville Row.
Glasgow—49, West Campbell Street.

LESLIE Mc MICHAEL LTD.

PROVIDENCE PLACE, WEST END LANE, KILBURN, N.W.6

Bus Services 1, 8, 16, 28, 31 all pass West End Lane

Telephone: HAMPSTEAD 1261 Nearest Tube Station: KILBURN PARK (BAKERLOO)

BROADCASTING SETS (ex Government)

Pending the issue of our M.H. Broadcasting Sets, we have in the meantime obtained permission from the G.P.O. to issue the following ex-Government sets under the Broadcasting scheme.

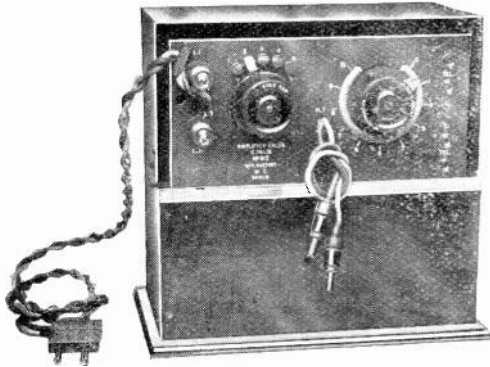

Radiomac 3B, three valve set.

Covering the entire broadcasting range with plug for coils to cover all wavelengths, in hinged mahogany box, set only **£12 12 0**

Accessories as set out below, with extra valve **£6 0 0**

Licence fee payable to Broadcasting Company **£2 5 0**

(Illustration does not show Variable Condenser provided in set.)

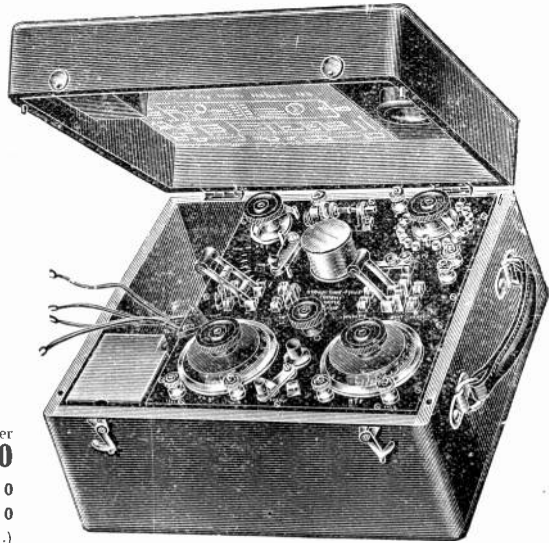

Radiomac Crystal Mark III.

Range of set about 50 miles, wavelength 150 to 1,200 metres, covers the entire broadcasting and shipping range (Aeroplane and Dutch Concerts). Brand new, in mahogany box, complete with pair of 1,000 ohm telephones **£10 10 0**

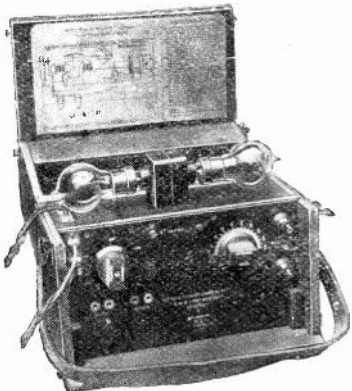

Pattern A (close-up type)

Radiomac 2B

In polished mahogany box, either open or close-up type, range 200 miles, covering the entire broadcasting range, and with plug for coils to cover all other wavelengths. Price of set only **£9 9 0**

Accessories required for above sets are:—
 1-volt 40 ampere hour accumulator in box, **£1 5s.**; 2 Marconi Osram valves, **£1 15s.**;
 1 pair 4,000 ohm telephones, from **£1 5s.**;
 or if Brown's "A" type diaphragm, new, **£2 15s.**; 100' aerial wire, 7 6; 6 insulators, **3s.**;
 1 H.T. unit, 36 volts, 7 6. Total, **£5 3s.**
 Licence fee payable to Broadcast Company, **£1 15s.**

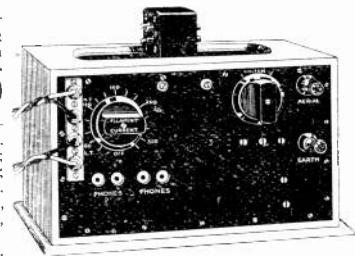

Pattern B (open type)

This apparatus was originally purchased by H.M. Government at a figure very much in excess of the price at which we are selling same. They are unused, in perfect electrical and mechanical condition, and form a very attractive and compact set. We guarantee the performance of each of these sets to be equal, if not superior, to any of the highest priced sets now existing on the market, and will take back any apparatus failing to answer this description.

32/- per Pair
4000 ohms.

Al. Resist-
ances in
stock.



---CQ Std bi for ERICSSON PHONES

WHEN you instal your wireless set—crystal or valve—you'll get maximum results if you fit Ericsson Phones—clarity, sensitivity, strength of signals and absence of "click." Specially suited to telephony. Ericsson Phones embody the accumulated experience of telephone manufacture for a generation. Easy to the head, light and comfortable. The magnets never lose their strength and "shorts" are non-existent.

Write for Particulars

The BRITISH L. M. ERICSSON
MANUFACTURING Co., Ltd.

Head Office : 67/73, International
Buildings, Kingsway W.C.

Ericsson

TELEPHONES

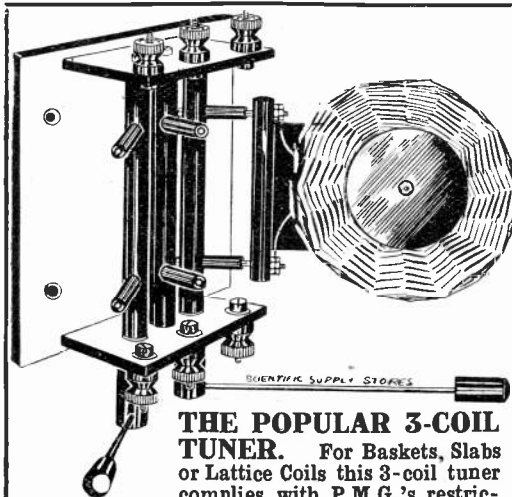

THE POPULAR 3-COIL TUNER.

For Baskets, Slabs or Lattice Coils this 3-coil tuner complies with P.M.G.'s restriction combining the highest efficiency with cheapness and practicability. With a set of Baskets this makes the most perfect Telephony tuning unit from 150-4,000 metres on the market. Tuning Stand with 3 coil holders, 12/6, post 9d. extra. Coil Holders, 1/3 each. Tuning Stand with 7 coil holders and set of Baskets, 21/6, post 1/-.

Scientific Supply Stores,
8, Newington Causeway, London, S.E.1

Phone—Hop 4177.

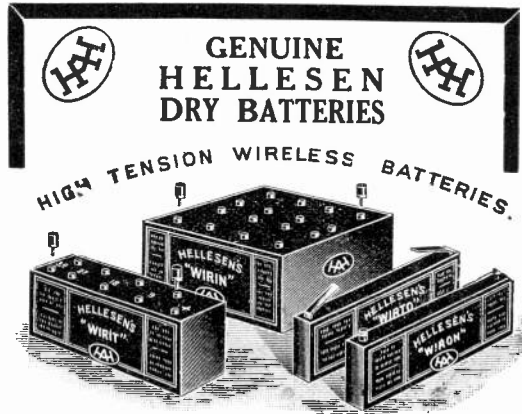

GENUINE
HELLESEN
DRY BATTERIES

HIGH TENSION WIRELESS BATTERIES.

SPECIAL TRADE AND WHOLESALE TERMS			
Code word.	Volts.	Details.	Price.
"WIRON"	15	Screw terminals	4/- each
"WIRTO"	15	Strip	4/- "
"WIRIT"	36	2 insulated wander plugs	8/6 "
"WIRIN"	60	2 " "	14/- "

Wander Plugs and Terminals are included in the price of the Battery and are NOT AN EXTRA.

**KNOWN THE WORLD OVER AS
THE BEST.**

ALL LISTS FREE ON APPLICATION.

A. H. HUNT, LTD.
H.A.H. Works, Tunstall Rd., Croydon, Surrey

AUCKLAND'S

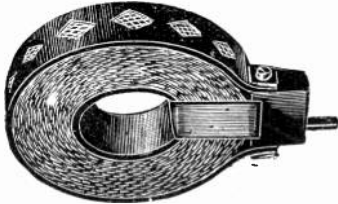

**AUCKLAND (Igranic)
DUO LATERAL COILS.**
Made under De Forest Patents.
PRICES from **5/-**
Mounted.



CONDENSER DIALS.
Fitted with Knob and Bush,
Engraved to 180°
3/9 each.



**NOTE MAGNIFIER.
1 VALVE SELF-CONTAINED
UNIT.**
For attaching to Crystal Sets, etc.
Mounted in Cabinet with Terminals,
and suitably engraved, comprising
V-Holder; Fils. Res.; Intervalve
Transformer.
PRICE **65/-** Without Valve.

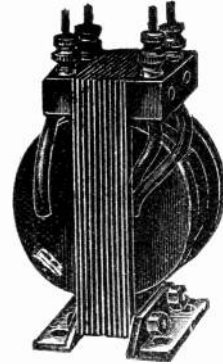

**INTERVALVE
TRANSFORMERS.**
Most Efficient Cores, being
built up of Stalloy and in
correct proportion.
The Bobbin is Layer Wound,
each Layer being Spaced.
Designed to give maximum
Amplification.
PRICE **20/-** each.
Delivery—Stock.

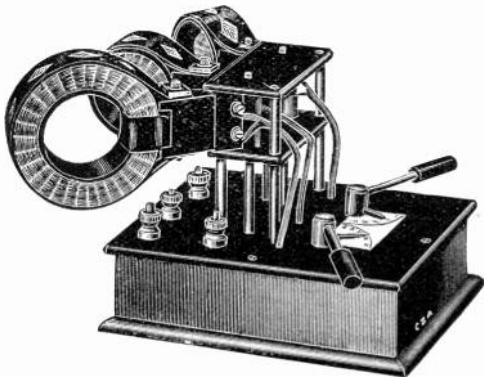

**A NEW
AUCKLAND
PRODUCT.**
3 Coil Holder with
Remote Control
keeping Capacity
effects from body.
Finish as a first-
class instrument.
PRICE
22/6
each.



**THE NEW
UNI-WAVE
INDUCTANCES**
Duo Wound.
Range from
300-30,000 m.
Inductive Values
are to be found in
Catalogue.
PRICE per set of 8
12/6

We are also Manufacturing
Complete Sets, for Broad-
cast use or Experimenters.

INSIST upon having AUCKLAND Products.

All AUCKLAND Valve Apparatus is duly licensed under Marconi Patents
for amateur use in Great Britain.

G. Z. AUCKLAND & SON, 395, St. John Street, E.C.1
Factories—ISLINGTON, N. WIRELESS INSTRUMENT MAKERS. 'Phone . . . 3173 CLERKENWELL

LONDON OFFICES:



Listen in — with the Fellows

Handphone which has been specially designed for ladies. It has no headband to catch or tear the hair. Beautifully finished and very comfortable to use.

PRICE (4000 ohms) **15/-** EACH
(Postage 1/-)

He will use Fellows **Headphones** with two earpieces in light die cast non-ringing metal wound to 4000 ohms.

PRICE **21/-** PER PAIR
(Postage 1/-)

All Fellows radio instruments are British Made throughout and guaranteed.

FELLOWS MAGNETO Co., Ltd.

LONDON, N.W.10

Telephone: Willesden 1560-1. Telegrams: Quixmag, Phone, London



11.

For they are jolly good Fellows

BROADCAST—CRYSTAL RECEIVERS FOR WIRELESS TELEPHONY, Etc.

A RELIABLE INSTRUMENT AT A LOW FIGURE.

Double Slide Tuning Coil, Spring Contact Crystal Detector, Engraved Ebonite Panel, Lacquered Terminals, the whole fitted into solid well seasoned, polished mahogany cabinet.

As illustration (Approximate Range 3,000 metres.) Post free:

£4 : 5 : 0

Complete with Double Headphones, 100 ft. of Aerial Wire and 3 Insulators.

Overseas postage Extra.

All that is necessary with these sets is to connect up the aerial and earth and telephones and with small adjustment signals should be received.

Fully illustrated list post free 4d.

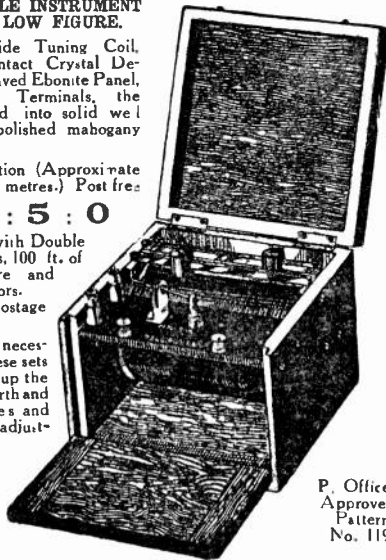

P. Office Approved Pattern No. 119.

Dimensions—6½ x 6½ x 5½. Approximate Weight—3 lbs.

H. D. BUTLER & CO., LIMITED,
Office & Showrooms:
Bank Buildings, 222, Gt. Dover Street, Borough, S.E.1
Telephone: Hop 3029. Works Canonbury, London, N.1.
Works North 1838. Telegrams: "Ingenuity Phone, London."

Say
"Ashdown"

If you want the best Resistance, and demand it.

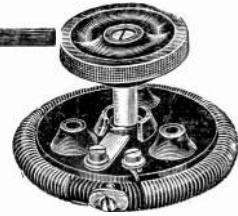

Reg. No. 691772

THE "ASHDOWN" Filament Resistance

is non-reversible and never disappoints. A superior article that has by sheer merit alone forced its way to the forefront.

Don't be put off with cheap stuff—the "ASHDOWN" costs no more than a really good resistance should.

Price 4/6

Stocks held by London Rep.:
Mr. J. O. Maddock,
11 Bayham Rd., Bedford Pk., W.

H. E. Ashdown (Birmingham) Ltd.
Perry Barr—Birmingham.

Phone: Northern 859.

Tel.: Segment.

Agent:
F. ESCOTT,
23, High St.,
Hampstead.

Efficient.

Specification.-1.

Manufactured, assembled and finished by highly skilled hand labour throughout. Bare, tinned internal wiring, bent on formers, and soldered at all connections, thus ensuring a noiseless circuit.

IMPORTANT:
Fixed Reaction is a Feature of this Receiver.

Introducing the

AUDIOPHONE

a Broadcast Receiver of MERIT

Agent:
J. T. HARTWELL,
5, West Chapel St.,
Mayfair, W.1.

Highly Sensitive.

EMPLOYING THE UNIT SYSTEM.

Specification.-2.

Polished ebonite panel, engraved white, functions of all knobs and terminals clearly indicated. The whole mounted in desk style polished mahogany cabinet. Wavelength range 300-550 m. Higher wavelengths obtained by means of plug-in coils.

Fully approved by H. M. Postmaster-General.

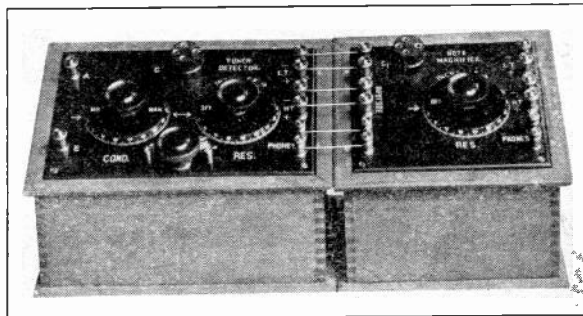

TUNER DETECTOR.

Price as shown **£7 : 7 : 0**
Complete with:—Siemens 60 v. H.T. 4 v. 50 amp. (actual) L.T., and M.O. Valve R. Type £11 : 12 : 0

Prices include Marconi Royalty and commission to B.B.C.

P.M.G. Reg. No. 1018.

NOTE MAGNIFIER.

Price **£4 : 5 : 0**
Complete with:—Marconi Osram R. Type Valve

£5 : 2 : 6

P.M.G. No. 3015.

TERMS :—Cash with order, or instruments on five days approval against full deposit.

Manufactured under Marconi Licence by **J. R. WRIGHT, 10, Carton St., Baker St., W.1.**

The Experimenter's own Tuner

HERE is a particularly efficient Tuning Unit designed for the amateur requiring the utmost efficiency and selectivity in tuning on all wavelengths. Two double pole rotary switches are used for Series-Parallel and for Stand-by-Tune. A solid Ebonite three coil Holder, of substantial construction, is supplied ready made. It will take all Standard Coils—but no Coils are supplied with the Tuner. Range from 180 metres to 26,000 metres with suitable Coils—with or without reaction.

Full Sets of Parts for assembling this excellent Tuner include : 16 Terminals, 2 Rotary Switches complete with studs and stops, Ebonite Panel drilled and tapped, set of engraved ebonite name plates, complete 3-Coil Holder, insulating tubing and wire. Full instructions for assembling and wiring are included with each Set.

£ 10 worth of Radio Goods offered free.

As so many customers have written to us expressing their satisfaction with this new Tuner, we are inaugurating a simple competition. All you have to do is to write us a letter of not more than about 250 words telling us your own experiences with it. Any special hints for quick tuning which you may have discovered—names of stations which you can now pick up which previously were out of your reach—notes on the elimination of atmospheric or near-by high power stations. Here are some suggestions for you. The three most interesting letters—selected by Mr. Paul Tyers, the well-known Radio authority—will win the prizes. All purchasers of this Tuner are eligible—no other conditions. Competition closes December 31st.

27/6

Mahogany Cabinet
to fit, 35/6 extra.

Combines the principles of the famous Mark III Tuner.

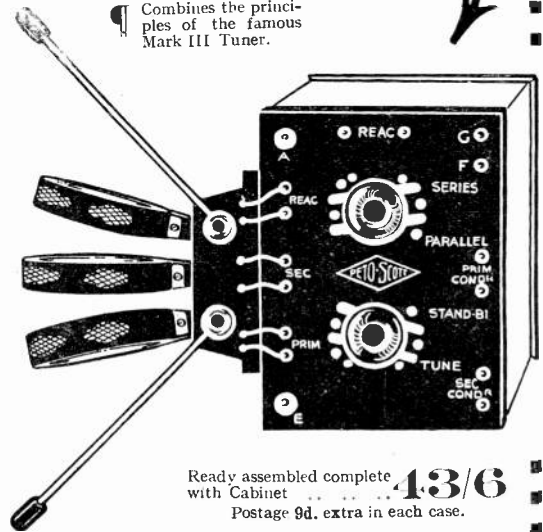

Ready assembled complete with Cabinet **43/6**
Postage 9d. extra in each case.

First Prize : Goods to the value of **£5**
Second Prize : Ditto Ditto **£3**
Third Prize : Ditto Ditto **£2**

To be selected by winners from Catalogue,
32 page Catalogue post free.

FEATHERSTONE HOUSE, 64, HIGH HOLBORN, W.C.1



M.A.S.

WIRELESS ENTHUSIASTS



"There is music in the air,
You can hear it everywhere"

If you use Wireless Accessories as
supplied by me.

Everything of the Best Quality and Finish.

CONDENSERS.

Mfd	Parts.	Assembled.	Mfd.	Parts.	Assembled.
·00005	1/6	—	·0005	5/6	7/6
·0001	2/3	3/-	·00075	6/9	9/-
·0002	2/6	3/6	·001	7/6	12/6
·0003	3/6	5/6	·0015	12/-	17/-

Hertzite Crystal, including four-screw brass cup	each	2/5
Five-way switches on ebonite	"	2/6
Condenser knobs	"	5d.
Crystal detector	"	5/-
Fixed Condensers any capacity	"	2/6
Fl. Resistances	"	5/-
Ebonite valve holders	"	1/2

Send for Price List to—

ALBERT DE SOLLA,
10, Little Saint Andrew Street, St. Martin's Lane, W.C.2.
'Phone, Gerrard 6725.

If goods are for mailing allow for postage and packing.
Post orders receive special attention.

SOMETHING NEW

JUST WHAT IS WANTED

H.F. Intervalve Transformer, Tuning
300-15,000 metres.

Primary and Secondary separately wound with Double Silk Covered Wire, each with 6 tappings to a Double Pole Switch. Any number of these can easily be connected together and **15/6** operated by one knob
Fitted with Reaction 10/6 extra; and with Condenser 5/6 extra.

Tuned Anode Coils.

Inductance and reaction with tappings and switches. Reaction Coupling working **£1**
0°-180° on engraved Ebonite Dial . . .
Fitted with Condenser 5/6 extra.

Filament Rheostat with Vernier Adjustment

controlled by one knob. Enables you to get EXACTLY on the very spot for perfect tuning. Engraved Ebonite Dial to show at all times just where it is set. No guessing . . . **7/6**

Mica Condensers.

Special Design Rotary Vane Type ·001 mfd. **9/6**
Panel Mounting
Mounted in Case with polished copper body 11/6.

All goods Approval against Cash. Postage extra.

Reno Scientific Instrument Co.
11, NEWTON ROAD, SWANAGE

TO TEST YOUR HIGH TENSION BATTERY YOU MUST USE A HIGH RESISTANCE VOLTMETER

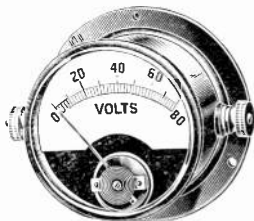

Moving Coil Type
2½ inch dial

We have designed a suitable instrument, to read to 80 volts.

Can be supplied in polished brass or nickelled case

Price 45/6 each

POST FREE. CASH WITH ORDER

WHITE ELECTRICAL INSTRUMENT CO. LTD.

2, 4 and 6, Gloucester Street, Clerkenwell, London, E.C.1

Telegrams : Voltograph, London.

'Phone : City 8660.

Multiply Your Telephony with
"THE BROADCASTER"

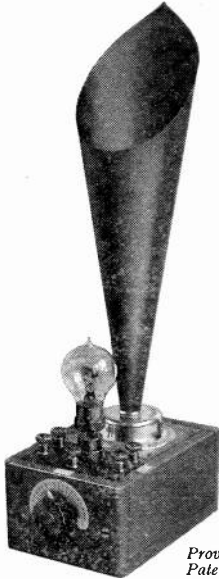

Prov.
Patent

A Sporting Offer

IF you are not more than satisfied with "The Broadcaster" we will refund you cash if returned within one week.

The biggest advancement, and last word in Loud Speakers. Designed on the proper lines.

"The Broadcaster" complete with R. Valve and Horn ... **Price £6 10 0**
 or less Valve **£5 15 0.** Carriage, etc., 2/6.

AGENTS.—There are a few districts still obtainable for the asking. Make money while you have the chance

BRITISH WIRELESS CO.

Incorporating

MIDLAND RADIOPHONE CO.

HEARSALL WORKS, COVENTRY

'Grams :
639 Coventry

'Phone:
639

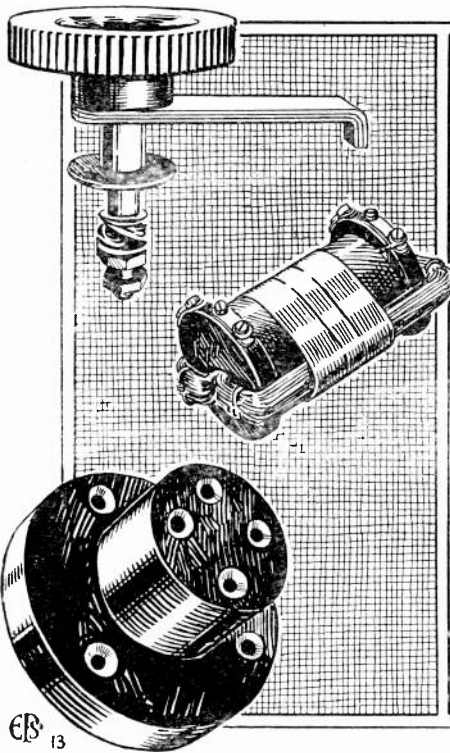

ES 13

A Complete Line of Wireless Components

We stock a complete line of wireless accessories and the following are a few examples of the good value offered.

Telephone Transformer, as illustrated, 15/6 each, or mounted in a box, with 4 terminals, 18/6 each (postage 4d.)

Valve Holders—best quality Ebonite and Brass, 1/9 each (postage 3d.)

Switch Arms, as illustrated, 3/6 each (postage 4d.)

Ebonite Slabs—best quality, matt or polished, 5/- each (postage 6d.) Size 6" x 12" x 1/4" thick.

*Send for fully illustrated Catalogue.
You will appreciate the values offered.*

For they are jolly good Fellows

FELLOWS MAGNETO CO., LTD.,
LONDON, N.W.10

Telephone : Willesden 1530-1. Telegrams : Q-xixmag, Phone, Lon cn.



RADIOPHONE BROADCASTING Receiving Sets

Approved by P.M.G.

Simplest on the Market

Neatest in Design

:: :: Compact :: ::

3-Valve Receiving Set Type R.L.3

Complete as shown

£27 : 10 : 0

Inclusive of Royalties, etc.

2-Valve Receiving Set Type R.L.2

£22 : 10 : 0

Complete

Simplicity with Satisfaction

Receiving Set
Type R.L.3

Description :—

Our sets are complete in every detail and of the finest workmanship throughout. The 3-valve set employs one rectifying valve, two note magnifying valves, coupled with a very efficient audio frequency transformer. The apparatus is mounted in a polished oak, walnut or mahogany box, and includes a 54 volt high tension battery, variable condenser, valve controlling switches, etc. The 3-valve receiving set is capable of being used as a 2-valve set by simply changing over

Trade Buyers are requested to write to-day for fully Illustrated
List and Terms for Re-sale.

RADIOPHONES LTD.

1a, Granville Place
Marble Arch
LONDON
W.1

Telephone—
MAYFAIR
1250

Telegrams—
"Radiopholim, Baker,
London."

CONDENSERS

DELIVERY FROM STOCK

High in Quality.

Low in Price.

Price

·001
10/6

·0005
8/6

·0003
7/6

*Other Sizes
in
Proportion.*

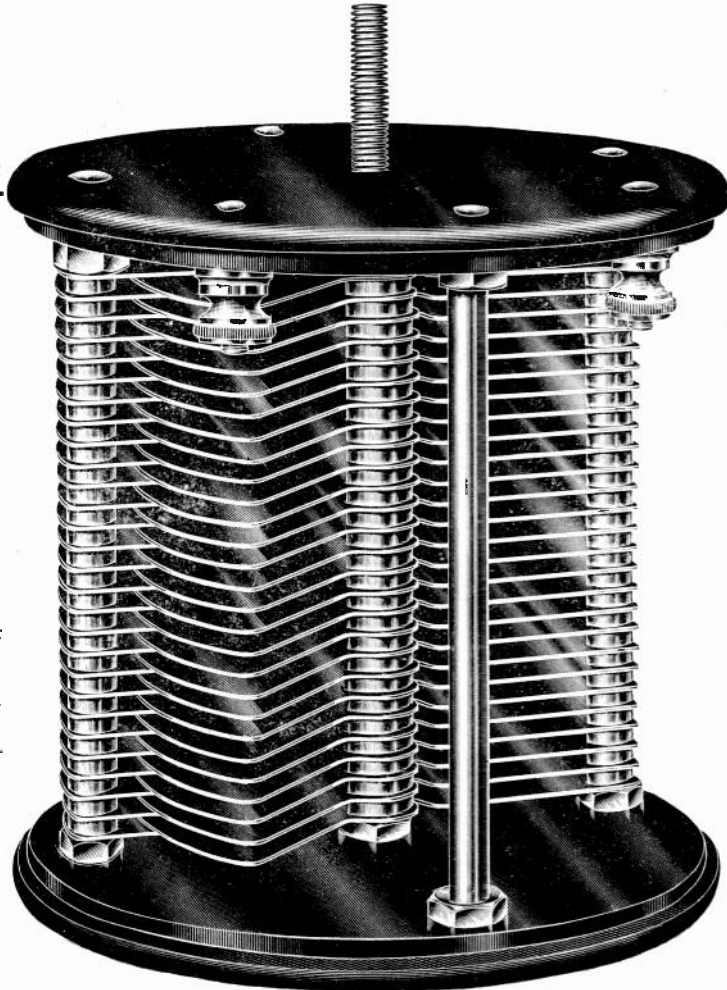

Price

·001
10/6

·0005
8/6

·0003
7/6

*Other Sizes
in
Proportion.*



ORMOND ENGINEERING CO.

199, Pentonville Road, King's Cross, N.1.

Telegrams : Ormondengi.

Telephone : Holborn 1812.

EXTRACTS FROM OUR CATALOGUE (3d. post free)

- Aerial Wire (7/22's enamelled hard drawn copper), per 100' coil 6/-
- Aerial Insulators, Shell Type, 2 1/2" x 2 1/2" approx., best glaze finish each 1/3
- Aerial Insulators, Reel Type, 2 1/2" dia. approx. each 3d.
- Aerial Insulators, Strainer, 2 1/2" x 1 1/2" approx. each 8d.
- Aerial Leading in Tubes, sturdy ebonite, 6" overall, each 1/8, 12" overall, each 2/-
- Aerial Pulleys, large 5 1/2" with tackle, hook and bucket, each 2/6
- Aerial Pulleys, small 2 3/4" each 1/-
- Accumulators (Oldham's Special Process)—
 - 4 volt 40 amp. I.C. each 20/-
 - 4 volt 60 amp. I.C. each 22/6
 - 6 volt 80 amp. I.C. each 27/6
 - 6 volt 60 amp. I.C. each 32/6
- Bamboo Canes for spreaders 6 ft. long each 1/6
- Brass Rod, screwed, 2 B.A. in 12" lengths each 5d.
- 3 B.A. in 12" lengths each 4 1/2d.
- 4 B.A. in 12" lengths each 4d.
- 5 B.A. in 12" lengths each 3 1/2d.
- Brass Washers, 2, 3, 4 or 5 B.A. doz. 4d.
- Brass Nuts, 2, 3, 4 or 5 B.A. doz. 4d.
- Batteries, Bell Flash Lamp, 5/- doz. Terminals to fit contacts of these 2/-
- Condenser Vanes, 2 1/2" diam., in .022" hard drawn aluminium doz. 9d.
- Condenser Vanes, other sizes see list.
- Condenser Spacing Washers. Accurate, large 6d. doz., small 4d.
- Condenser Centre Spindles from 4d. each
- Condensers, variable (see catalogue) each 2/-
- Condensers, fixed, .001 to .005 each 2/3
- .001 to .002 each 2/6
- .003 to .004 each 2/6
- Cabinets, beautifully polished mahogany (see catalogue).
- Crystal Cups (with screw to fix crystal) each 3d.
- Crystal Detectors (the neatest design and best finish on market) each 5/-
- Contact Studs (superior finish, 1/4" x 1/4", with nut and washer) doz. 1/-
- Contact Stops doz. 1/6
- Copper Foil Sheets (uniform thickness, 12" x 3") each 3d.
- Core Wire, soft iron in straight lengths lb. 2/4
- Coil Mounting Plugs, with screw connections each 1/6
- 3" Holders for panel mounting each 12/6
- Ebonite Engraved Dials lb. 5/-
- Ebonite Sheet, best quality, light not loaded lb. 5/-
- Filament Rheostats for Panel Mounting, the best offered each 3/6
- Grid Leaks and Condensers (tested with proper instruments) each 5/6
- High Frequency Transformers (improved type, double grooved) set 10s.
- Instrument Wires. Hundreds of miles in stock, competitive prices.
- Insulated Sleeving, 1 1/2 m.m. yard 6d.
- Insulation of all kinds, see catalogue.
- Inductance Sliders, with spring and plunger each 6d.
- Inductance Sliders Rod, in 13" lengths each 4d.
- Ivory Scales, engraved, not printed each 10d.
- Ivory Tablets (aerial, earth, primary, on, off, reactance, phones, H.T., H.T.-, L.T., L.T.-, A.T.I.), each 2d.
- Knobs, Ebonite, 1 1/2" diam. each 5d.
- Loud Speakers and Phones, see catalogue.
- Low Frequency Transformers, 24/- each. For description see catalogue.
- Paraffin Wax lb. 1/-
- Publications, see catalogue.
- Resistance Wires, 22 and 24 S.G.W. and enamelled 28 S.W.G. yd. 1d.
- Screws (brass) from 2d. doz.
- Spring Washers (2 B.A.), copper each 1d.
- Terminals from 1/9 doz.

Please include ample postage, balance will be returned.

J. L. CARTWRIGHT & CO.,

(Dept. W.) 24, LONDON ROAD, MANCHESTER.

Works: Berry Street.

*Phone: Central 4209. *Grams: "Pladuram, Manchester."

Sole Wholesale Distributing Agents for Scotland—

J. GORSTON SINCLAIR & CO., THOS. BARTON & CO.,

47, Waterloo Street, Glasgow. The Electric Works, Blackburn.

MARCONIPHONE SPECIALISTS

BEFORE purchasing your MARCONIPHONE or other Wireless Receiving Set, you will wish to have it Demonstrated in actual use when receiving Telephony from a Broadcasting Station.

Our Demonstration Lounge is open at six p.m. daily for the London Broadcast News Programme and Weather Report. All are welcome.

H. V. ALBROW,

(late Chief Technical Assistant, Yacht "ELETTRA")

56, George St., Baker St., London, W.1

Phone—Mayfair 5842. (Two minutes from Selfridge's)

All types of Wireless Apparatus and Accessories supplied. Small parts at competitive prices.

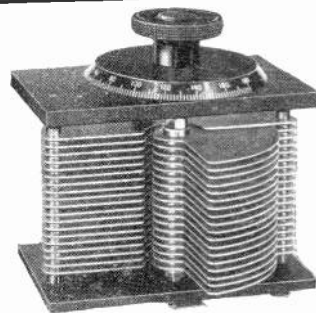

Specification of our well-known CONDENSERS. Highest grade Aluminium Plates, Brass Washers machined to a limit of + or - .011. Adjustable Brass Bush at bottom, Fixed Brass Bush at top.

These Condensers are built to stand HARD continuous use, and we GUARANTEE THEM

Value in M.F.	Panel Mounting in Parts	Panel Mounting Assembled	Cabinet Mounting in Parts	Cabinet Mounting Assembled	Cabinet Mounting Assembled in Cabinet	Pished Mahog- in Cabinet.
.0015 ..	23/-	25/6	24/-	26/6	33/-	6/3
.001 ..	16/9	19/6	17/9	21/-	28/-	5/6
.00075 ..	13/6	16/3	14/6	16/6	22/-	5/6
.0005 ..	10/6	13/-	11/9	13/9	18/-	4/6
.0004 ..	10/-	12/6	11/-	13/3	17/6	4/6
.0003 ..	9/-	11/6	10/-	12/-	16/-	4/-
.0002 ..	7/-	9/-	8/-	9/6	13/6	4/-
.0001 ..	6/-	8/-	7/-	8/6	12/6	4/-
Vernier..	—	4/6	—	5/-	9/-	3/6

Fitted with Bevelled Ebonite Dial 1/9 extra.

Special Sizes made to Order. Price list on request.

ALL SUNDRIES AND COMPONENTS IN STOCK.

ORDERS OVER 20/- CARRIAGE PAID.

TRADE ENQUIRIES SOLICITED.

THE "BROADWAY" RADIO WORKS
DEVONSHIRE ROAD, BEXLEYHEATH, KENT.

C.A.Co.

An Ideal Xmas Gift—Order Now

The Best Value in Single Valve Panel Sets on the market

No Finer Set could be built if 20 times the price were paid

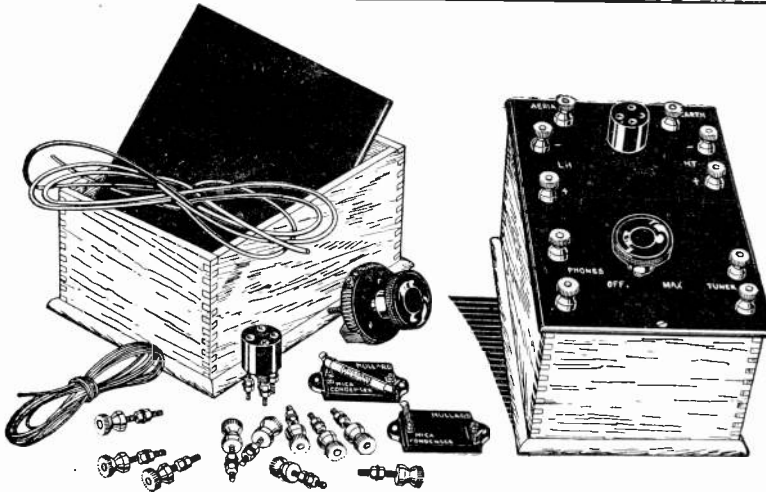

30/-

Complete

Comprising — Handsome polished mahogany cabinet, panel of best quality ebonite, well finished and bevelled edges, valve holder, filament resistance, 2 Mullard's Condensers, .0003 and .0002 mfd. Mullard's Grid Leak, 10 Terminals, 10 engraved terminal tablets, coloured systoflex and copper wire, blue print with full instructions.

Hundreds of these sets have already been sold. As will be observed, **ONLY THE VERY BEST COMPONENTS ARE SUPPLIED.** This is the secret of the success and popularity of this panel.

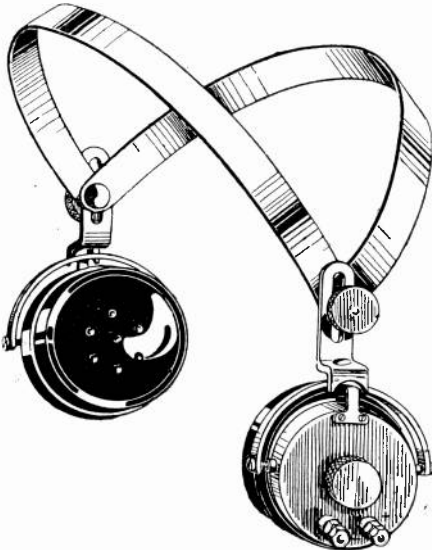

A Good Pair of Phones makes an exceptional Xmas Gift that will be appreciated by the recipient.

BROWN "A" TYPE, Aluminium Diaphragms at much below makers' prices. (Cords 3/6 extra)	
120 ohms (maker's price 58/-)	£2 2 6
120 ohms Complete with Telephone Transformer (Value 25/-) in Iron Case	2 15 0
8,000 ohms (maker's price 66/-)	2 9 6
SULLIVAN PHONES (with Brown's Aluminium Headbands).	
120 ohms	12 6
120 ohms Complete with Telephone Transformer (Value 25/- in Iron Case	1 10 0
8,000 ohms	1 16 6

☞ All our goods are sent on approval, against cash, for seven days.

THE CITY ACCUMULATOR CO., 79 Mark Lane, London, E.C.3

Phone: AVENUE 1316.

Wholesale and Retail Distributors for Messrs. BURNDIPT, Ltd. Same Trade Discount Allowed as by Manufacturers.

AGENTS—London: H. V. ALBROW, 56, George Street, Portman Square, W.1.

Glos.: BRISTOL WIRELESS CO., 52, Cotham Hill, Bristol.

Leicester: WALTER ROWE, LTD., 96, Granby Street, Leicester.

S. Wales: SOUTH WALES WIRELESS INSTALLATION CO., LTD., 18, West Bude Street, Cardiff.

N. Wales, Lancs., Ches. & L.O.M.: THE "ALL-BRITISH" WIRELESS MANUFACTURES CO., LTD., 18, Vauxhall Road, Liverpool.

C.A.Co.

IMPORTANT NOTICE to all Amateurs, Experimenters, Manufacturers and Retailers.

We have completed the purchase of the largest stock of

Ex-Govt. Wireless Material

Ever handled by an individual firm, and it is our intention to offer the same for re-sale at astonishingly low prices in accordance with our inevitable rule to

SHARE OUR BARGAINS WITH OUR CUSTOMERS

We would again emphasise the fact that

It is unnecessary to pay fancy prices for ex-Disposal Board Wireless Apparatus.

As an example of the bargains that are to follow, we are offering the following preliminary items:

RECEIVERS, C.W. MARK III

This set comprises a complete 2-valve Receiving Set, with a wave-length range of 350-1,800 metres. The addition of High and Low Tension Batteries, valves, and 'phones completes the entire receiving station. For the reception of Broadcast concerts this set is ideal, the strength and clarity of the signals being absolutely wonderful. London readers should take the opportunity of hearing this set working at our Showrooms. **Only 200 left. Price £9 9s.**

Complete with 4-volt 40-amp. Fuller Block Accumulator, 60-volt H.T. Battery, 2 Mullard "ORA" Valves, and pair of Brown "A" Type Headphones, complete with cords **£15 10s.**

AMPLIFIERS, C. MARK IV

This instrument is a complete 3-valve low frequency amplifier, and can be used in many ways without modification.

The C. Mark IV Amplifier is an improvement on the C. Mark III (the latter being sold by other dealers at £6 5s. each without cases), inasmuch as the C. Mark IV contains terminals and change-over switch, allowing the use of the instrument for either high or low-frequency amplification.

The price at which we are offering these amplifiers is less than the actual value of the transformers contained in the instrument. **Price, complete in Mahogany Case... £4 5s.**

INSULATED AERIALS

40-feet, 1s. 60-feet 1s. 6d.

Kindly note that the above prices do not include packing and carriage. Please add, therefore, an appropriate amount to cover this. Any surplus will be refunded.

THE CITY ACCUMULATOR CO. 79, MARK LANE, LONDON, E.C.3

Phone—AVENUE 1316.

Wholesale and Retail Distributors for Messrs. BURNEPT, Lt.1. Same Trade Discount Allowed as by Manufacturers.

AGENTS—

London: H. V. ALBROW, 56, George Street, Portman Square, W.1.
Glos.: BRISTOL WIRELESS Co., 52, Cotham Hill, Bristol.
Leicester: WALTER ROWE, LTD., 96, Granby Street, Leicester.

C.W. TRANSMITTERS, MARK III, 30-WATT

For two valves. Complete, with aerial, ammeter, platinum-pointed Morse Key, in mahogany case. Wavelength range, 300-1,800 metres.

NOTE.—This set can be conveniently converted into a 2-valve **Detector-Amplifying Receiver.**
Price £3 5s.

B MARK II RECEIVERS

Vertical pattern. Can be easily converted to any wavelength. **£3 15s.**

Above, fitted with Variable Air Condenser, .0005 mfd., in place of change-over switch. **£4 15s.**

HETERODYNE WAVEMETERS, 500-3,000 METRES

For Receiving, without Galvanometer **£2**

For Transmitting and Receiving, containing Weston Galvanometer **£3**

AERIAL MASTS AND EQUIPMENT

15-foot Steel Masts in Sections, each 2 ft. 8½ ins. complete with Halyard, Pulley, and Stays. Can be erected by one man, and are portable. The height can be increased up to 30 feet by the use of extra stays. **Per Set Complete, 15s.**

30-foot DITTO, in SECTIONS, each 4 ft. 3 in. (without stays). **Per Set Complete . . 17s. 6d.**

SULLIVAN HEADPHONES

120 ohms **12s. 6d.**

SULLIVAN HEADPHONES

120 ohms complete with new Telephone Transformer (value 25s.) in iron case **£1 10s.**

TO WIRELESS ADVERTISERS

WHAT are your plans? What arrangements are you making for business development in the future? Behind every progressive commercial enterprise there must be a definite and connected scheme. Progress is never the result of haphazard methods.

ARE you satisfied that your plans for advertising, selling and distribution are being conducted on the right lines? If you have any doubts why not call in the expert advice I am able to offer you? My Wireless Advertising Organisation—the product of over ten years' highly specialised advertising practice—is at your disposal free of all obligation.

TO every bona fide advertiser who cares to furnish me with the necessary particulars, I am prepared to supply, entirely free of charge, a detailed report as to his most effective future business policy together with suggestions for a complete Selling Campaign. If possible please phone or write for a preliminary interview.

Bertram Day

BERTRAM DAY & CO., LTD.,

*Wireless Advertising Specialists
Contractors, Printers & Publishers*

B
|
D

*Organisers of the First All-
British Wireless Exhibition, 1922*

9 and 10, CHARING CROSS, S.W.1

BRANCHES AT MANCHESTER & GLASGOW

GERRARD - 8063, 8064 and 8065
"ADBERTRADA, WESTRAND, LONDON"

STALLOY TRANSFORMER LAMINATIONS

SOLE MANUFACTURERS AND SUPPLIERS
JOSEPH SANKEY & SONS LTD
 WORKS: BILSTON, STAFFS. London Office: 168 RECENT ST. W.I.
TELEPHONE RECEIVER DIAPHRAGMS

Audio Frequency Intervalve Transformer

PRICE 16/- Postage 9d.

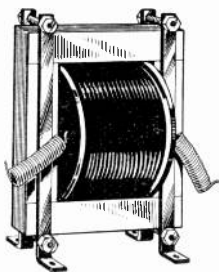

NOTE THESE POINTS :-
 Genuine Stalloy laminations. Wound with large gauge wire to eliminate risk of burning out. Distortionless, silent in action, tested with 500 volts and fully guaranteed.
 This transformer mounted in cabinet, ebonite panel with terminals, valveholder and filament resistance for use as note magnifier with crystal and valve sets. **Price 45/-.**
A. WOOD
 Manufacturing Electrical Engineer
 44, BRACEBRIDGE ST., NUNEATON

TO THE TRADE

EBONITE - SHEETS - RODS
COPPER WIRE - STANDARD GAUGES
AERIALS - SLEEVING, &c.

CABLES & ELECTRICAL SUPPLIES.
 MICA HOUSE, OFFORD STREET, Telephone:
 CALEDONIAN ROAD, LONDON, N.I. North 805.

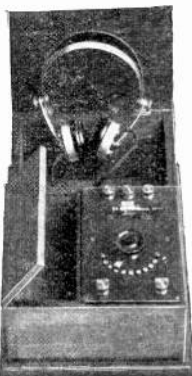

A Guaranteed Crystal Set.

The "O-SOLOWD" has been approved by the Postmaster-General.

COMPLETE AND READY FOR USE.

Consists of Polished Walnut Cabinet, Crystal Detector totally enclosed and therefore protected from its worst enemy "dust." High quality British Headphones (H.R., Two Earpieces), 100 feet of Aerial wire and Insulators.

The "O-SOLOWD" clearly receives music, speech and Morse messages.

It is an ideal Christmas Gift of exclusive design and finish.

LIBERAL TRADE DISCOUNT. AGENTS REQUIRED.

"O-SOLOWD" SET No. 4.
 PRICE
£5 : 5 : 0
 COMPLETE.

BRITISH RADIO WIRELESS MANUFACTURING CO., LTD.,
 11 GERRARD STREET, LONDON, W.1 Works: Weybridge, Surrey.
 Manufacturers of Aerial Masts, Wireless Cabinets and Boxes, Valve and Crystal Sets, etc

WITH GOOD APPARATUS YOU
 CAN GET GOOD RESULTS
 THE "W.P."

Morse Practice Key

Well Made. First-class Finish. Thoroughly Reliable.

Price **7/6** Post Free

THE WIRELESS PRESS, LTD.
 12-13, Henrietta Street, London, W.G.2

Questions and Answers COUPON

To accompany Questions
 sent in during the week
 commencing Dec. 9th, 1922.

VOL. XI, NO. 10.

See Conditions on Page 353.

THE WIRELESS WORLD EXCHANGE AND MART

TARIFF. Advertisements are accepted for this Section at the rate of twopence per word, with a minimum charge of two shillings. The advertiser's name and address will be charged for, and single letters and single figures will be counted as words. Compound words will be counted as two words.

DEPOSITS. All advertisements must be prepaid in the form of Postal Orders, the remittance being forwarded to Messrs. Bertram Day & Co., Ltd., 9 & 10 Charing Cross, S.W.1.

Intending purchasers may deposit the purchase money of any article advertised or sold by advertisers with Messrs. Bertram Day & Co., Ltd., who will acknowledge its receipt to the vendor and the depositor, the full addresses of whom should be given.

Wireless Apparatus

and parts designed and manufactured at our fully equipped works. High class work and finish.

MOORES & GRIFFITHS, LTD.,
BEXLEYHEATH, KENT.

*Phone, Bexleyheath, 114. Wire: Scoops Bexleyheath.
Manufacturers of "Broadwave" Receiving Set, P.O. Regd. No. 168.



WESTON MOVING COIL RELAYS,

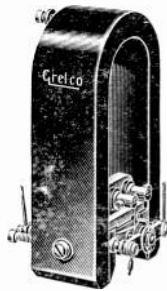

Undoubtedly the most Sensitive Relay made.

Platinum Contacts, eminently suitable for wireless recording or Experimental work. Perfectly new as received from makers.

Price, 20/- each. Packing and post, 1/6.

Note: These originally cost the trade 28 to £10 each.

Basket Coils (150 to 4,500 metres), excellent for telephony. Per Set 5/-

- Grid Leaks (enclosed), 2 meg. 1/-
- Aerial Wire, stranded, 7/25, 100' 3/6
- Filament Resistances 3/6
- Perikon Detectors on ebonite, complete with crystals 4/-
- Valve Holders, screwed legs 9d.
- Highly Glazed Green Egg Insulators. Best for aeri-als. 4d.
- Knobs, best quality, with 2 B.A. brass inset 4d.
- Siemens Halske Valves, excellent for amplifying and rectifying 7/6

All Goods dispatched the same day as order received.

Catalogue in preparation.

Postage extra.

Grafton Electric Company

Showrooms—54, GRAFTON STREET, TOTTENHAM COURT ROAD, LONDON, W.1. Telephone—Museum 241. Works—Slough.

FOR SALE.

Mark III* Tuner, excellent condition. £8 16s. or offer.—HATTAM, 63 St. Andrew Street, Hertford.
Cheapest House for Parts. Terminals, 1s. rod. doz. Contact studs, large, 1s. 3d. doz. Valve sockets, 14d. each. Crystal cups, 1d. and 3d. each. All with nuts. Galena, 3d. piece. All parts for crystal sets. lowest prices. Few valve sets very cheap. Postage extra.—245, Heath Street, Birmingham.

Huge Purchase of Ex-Government Wireless Stock.—Write for list giving full details. 150-watt dynamos, £1; loud speakers, 200 ohms, 7s. 6d.; 1" spark coils, 10s.; 1½" spark coils, 12s. 6d.; Morse tapping keys, 3s., etc., etc., etc., etc. Three days' approval against cash, or please call. Write for detailed price list of all goods.—E. J. GALPIN, 16, Loampit Hill, Lewisham, S.E.13, London.

Condenser Cases, finest quality teak, French polished, size 5½ x 5½ x 4½, 3s. 6d. each. Other sizes proportionate, delivery from stock.—HITCHCOCK Colchester.

Four-Valve Panel. 1 H.F. Det. and 2 L.F. valves, £8. Seen working.—24, Appach Road, Brixton, S.W.2.

Wireless: Complete Four-valve Receiving Set, with all accessories, including loud speaker, valves, tuning condensers, duo lateral coils and holder, telephone transformer, accumulator, H.T. batteries. Demonstration any evening after 8. Bargain, £35.—41, Newlyn Road, Lordship Lane, Tottenham.

Loud Speaker, mounted on polished mahogany base, 16" horn, with 4,000 ohm receiver. A bargain, 25s. Packing etc. 1s. 6d.—WILLIAMS, 1, Allesley Old Road, Coventry.

Coil Stands, panel-mounting, complete with three holders for basket coils, 7s. 6d. each, post free. Ask for list of new and ex-Government apparatus.—JACKSON, 104, Trafalgar Road, Old Kent Road, S.E.

Two-valve C.W. and Phone Transmitter, complete, £18. Particulars and list of other gear send stamp to Woods, 28, Durham Road, Plumstead.

Three-valve Set, H.F., D., L.F. complete. Accumulators, 'phones, tuner, H.T. battery, valves, aerial, insulators, etc. New, unused, cost £18 10s., by Stanley Prince, London, accept £14. Bargain.—BRD, Patrington, Hull.

Wireless Masts—Light and strong. Easily erected. Complete equipment, 16", 12s. 9d.; 32", 27s. 6d.; 45", 50s. Also parts and fittings. Stamp.—DERWENT MAST CO., 61, Arthur Street, Derby. Trade supplied.

Double Headphones, 2,000 ohms, with leads, very sensitive, 15s. per pair, complete set of parts for constructing your own single valve receiving panel, including polished case, coils wound, 55s.—CLARKE, 406, York Road, Wandsworth.

Burndept Ultra III Receiver, in perfect condition, cost £25. What offers?—Box K.7, BERTRAM DAY'S ADVERTISING OFFICES, 9 and 10, Charing Cross, S.W.1.

Loud Speaker Horns, guaranteed perfect acoustics. Enamelled black matt, complete with polished aluminium base for receiver, 4s. 6d. Post, etc., 1s.—MIDLAND RADIOPHONE CO., Hearsall Works, Coventry.

Three L.F. Inter-valve Transformers. Sullivan, perfectly new. What offers?—JARRATT, 26, Palace Road, Streatham Hill.

Wavemeters, New Calibrated, two guineas. Amplifiers, etc., state requirements. Lists 2d.—CENTRAL RADIO, 163, Middle Furlong Road, Nottingham.

Wireless Enthusiasts, Please Note. Just what you require. No more split acid if you use the "Service" carrying case. Strongly built, with leather straps and comfortable handle. Fills a long-felt want. Price 35s., postage 1s. Please state length and breadth of accumulator. If over 12" x 6", prices on application. Money refunded if not satisfied.—GEORGE BROTHERS, 617, Boro' Road, Birkenhead.

Your Case Work

Let us quote you for your wireless casework. We are specialists in this class of work and feel sure our workmanship and prices will interest you.

Phone—L.W. 2720.

CARRINGTON & NEWBERRY LTD.,
18/20, Normans Buildings, Old Street, E.C.

RESULTS

Whether as a source of practical information for the Amateur or as a valuable medium for every Advertiser, the best results are invariably obtained through the "WIRELESS WORLD"

For full particulars and advertising rates apply to

BERTRAM DAY & Co. Ltd.
Complete Advertising Service,
9 & 10, CHARING CROSS, S.W.1
Gerrard 8063 and 8064.

HEATH & Co., Ltd.

Instrument Works, New Eltham, S.E.9 are prepared to undertake in their fully equipped works—**Wireless Apparatus and Parts for the trade.** Quotations given to Blue Prints. Immediate attention.
Phone—Lee Green 301. Wire—Polaris, London.

GECOPHONE RECEIVING SETS APPROVED BY THE POSTMASTER-GENERAL FOR THE RECEPTION OF ALL BROADCASTING
No. 1 Crystal Set. Range 25 miles, £5 10s.
No. 2 Crystal Set. Range 30 miles, £9 15s. complete with buzzer combined for fine adjustment of crystal. The above sets complete with aerial and all accessories.

Two-Valve Set Complete in mahogany cabinet with mahogany case for 'phones, and teak case with straps for accumulator. Range 100 miles, £25.

All the above sets are manufactured and guaranteed by The General Electric Co., Ltd. Write for Illustrated Lists.

WIRELESS SUPPLY,
21, GEORGE STREET, HULL.

Wireless Poles

Gov. Surplus. Prime quality painted wood, 13', 1/11; 18', 3/6; sectional 27', 12/-; Iron Taper and Parallel Poles, 32', 30/-; 40', 35/-. Also stays, insulators, anchors, aeri-als. Enquiries solicited. Send stamp for list.

Jennings, Ltd., Wireless, Bristol.

BOOKS.

Radio Magazines, all the latest, "Radio World," 10½d.; "Popular Radio," 10½d.; "Radio Broadcast," 1s. 6d.; "Radio News," 1s. 6d.; "Science and Invention," 1s. 9d.; "Scientific American," 2s. 6d. Post free.—INTERNATIONAL NEWS COMPANY, LTD., 15, Bream's Buildings, London, E.C.4.

THE WIRELESS WORLD EXCHANGE AND MART

BACON AND COATES.

Radio Supplies Depot, Royal Arcade, Keighley.
SPECIAL THIS WEEK.

Flash Lamp Batteries for H.T., new, doz.	5/6
Flash Lamp Batteries for H.T., soldered	6/6
100' 7/22 Copper enamelled wire	5/-
Aerial Insulators, non-hygroscopic, each	4d.
Filament Rheostats, extra smooth, each	4/6
H.F. Transformers, 300, 400 and 600 metres	3/9
H.F. Transformers, formers only, each	2/3
L.F. Transformers, tested 1,000 volts	22/6
Switch Arms, 4-ply copper	2/8
Ebonite (guaranteed)	1b. 4/6
Contact Studs with nuts	doz. 1/6
Condenser Vanes, polished	pair 14d.
Condenser Washers, fixed vanes	doz. 34d.
Condenser Washers, moving vanes, doz.	6d.
Condenser Spindles, according to length.	
Condenser Screwed Rod	ft. 6d.
Condenser Scales, engraved ebonite, each	3/6
Condenser, complete, .0005	each 13/6
Condenser, set of parts	per set 11/6
Sistoflex, strong	yard 6d.
Terminals	doz. 2/6
Dubilier Condensers	each 2/6 and 3/6
Do. Grid Leaks, 2 megohm	each 2/6
Brown phones, new, 4,000 ohm	pair 30/-
Stop Pins	doz. 4d.
Split pins	doz. 1/6
Mullard ORA Valves, tested	each 15/-
B.T.H. Valves, tested	each 15/-
Polished ebonite knobs	each 6d.
Ebonite Valve Sockets, polished, screwed legs	each 1/4
Ebonite Valve Sockets, polished, with flange	each 1/10

Orders over £2 carriage paid.

Have you seen them ? Have you heard them ?

L.F. TRANSFORMERS.
The last word in efficiency. Price 21/- each

H.F. PLUG-IN TRANSFORMERS.
350-450 metres Price 6/6 each
900-1,100 metres Price 7/6 each

Manufactured at our Works.
Liberal discounts to the Trade.

P. H. BOYS & CO.
Electrical and Wireless Engineers,
187, Goswell Road, London, E.C.1.
Phone : - - - - - Clerkenwell 4454.

WIRELESS CABINETS
PROMPT DELIVERIES
COMPETITIVE PRICES
PICKETT BROS.,
Albion Rd., BEXLEYHEATH, S.E.

ALL BRITISH PHONES
21s. per pair. Post Free. (4,000 ohms)
Illustrated Catalogue including
List of Stations, 6d. Post Free.

BOONS WIRELESS SUPPLY CO.,
:: :: 115, Fleet Street, E.C.4. :: ::

TRADE ENQUIRIES.
Manufacturers of Horns for Loud Speakers are requested to send particulars and prices to advertiser who is marketing loud speaker in large quantities.—Box L.7, BERTRAM DAY'S ADVERTISING OFFICES, 9 & 10, Charing Cross, S.W.1.

FOR SALE—continued.

Brand New 2-Valve Receiver, polished mahogany cabinet, H.T. and valves. Cash wanted, must sell. Best offer secures.—LESLIE, 2, Melbourne Place, Exeter.

Five Wireless Sets Given Away. Particulars 3d.—HINKS, Wireless Dept., Hardington, Yeovil.

All Wireless and Electrical Goods stocked at 9, Colonial Avenue, Minorities, near Aldgate Station. Handiest place for City buyers.—LESLIE DIXON & Co., Telephone No. Avenue 4166.

R. Valves, 10/ each. £5 per dozen. B. Valves 12s. each, £6 per dozen. All new and tested. Post free. Ebonite Variometer Rotor, 5s. each.—B. CALVER, 52, Linver Road, London, S.W.6.

B.A. Screws, Nuts and Washers, assorted gross 2s., lists 2d.—J. H. BENNETT, Station Road, Willenden Junction.

Wireless Masts.—Improved Girder Type, light and strong, 30 to 50 ft. at 1s. ft., 50 to 100 ft. at 1s. 6d. ft. Cash with order, carriage forward.—F. ARMSTRONG, Weybridge.

SITUATIONS VACANT.

Vacancy occurs for young well-educated man, with thorough knowledge of practical wireless, able to write good commercial English, progressive position. Apply in writing with full particulars of qualifications, age, salary expected.—Box O.3, BERTRAM DAY'S ADVERTISING OFFICES, 9 and 10, Charing Cross, S.W.1.

Subscription Representatives (whole or part time) required, for well-known popular science periodical, dealing with Wireless. Apply, giving personal particulars to Box R. 5, BERTRAM DAY'S ADVERTISING OFFICES, 9 & 10, Charing Cross, S.W.1.

SITUATIONS WANTED.

Capable Wireless Worker, ten years experience, practical and commercial, desires progressive position with large or small firm, designing, erecting, supervising, testing, good organiser.—Box K.6, BERTRAM DAY'S ADVERTISING OFFICES, 9 and 10, Charing Cross, S.W.1.

Young Man, Certificate of Proficiency, designing and manufacturing experience, wireless apparatus.—Box B.8, BERTRAM DAY'S ADVERTISING OFFICES, 9 and 10, Charing Cross, S.W.1.

Energetic Young Man desires appointment with wireless firm, ex-mercantile operator. First Class P.M.G., six years modern office experience, costing, etc., good references. At present on staff big manufacturers.—SHIELD, Walnut Tree House, Levens, Milnthorpe, Westmorland.

CIVIL SERVICE COMMISSION.

Forthcoming Examination.—Male Assistant Superintendent of Traffic (Class III) in the London Telephone Service, and Male Assistant Traffic Superintendent in the Provinces (18.22, with extension for service in H.M. Forces during the war), January 11th, 1923. The date specified is the latest at which applications can be received. They must be made on forms to be obtained, with particulars, from the SECRETARY, Civil Service Commission, Burlington Gardens, London, W.1.

AGENTS WANTED.

Old-established London Firm, making one to five-valve broadcast receivers, desires provincial agents. Every assistance and good terms offered.—Box 76, c/o F. ALDRIDGE, 26, Paternoster Row, E.C.4.

Wireless Dealers throughout Great Britain are strongly advised to stock parts for making up wireless sets. Buy your parts direct from the factory at wholesale prices.—NEWTONIA WIRELESS FACTORY, 13 and 15, Whitcomb Street, W.C.2.

MISCELLANEOUS.

If you require a full experimental receiving and transmitting licence you must satisfy the G.P.O. that you have a sufficient knowledge of W.T. science to warrant the issue of such a licence.—THE LONDON TELEGRAPH TRAINING COLLEGE, LTD., will give you the necessary qualifications in 12 lessons. Write for full particulars of evening lectures to Secretary (Dept. A.T.), 262, Earl's Court Road, S.W.5.

Telephone Receivers Rewound up to 1,000 ohms, 5s.; 2,000, 7s. 6d. Cash with order.—M. E. HAMPSHIRE, 139, Sydenham Road, S.E.26.

PORTLAND'S Parts by Post. "EBONITE"

	s. d.		s. d.
4x4	1 3	12x7	5 2
7x5 1/2	2 8	12x8 1/2	6 5
8x6	3 0	12x10	7 6
9x6	3 5	15x8 1/2	8 0
10x6	3 9	12x12	9 0
12x5 1/2	4 2	17 1/2x8 1/2	9 6
9x8 1/2	4 10	14x12	10 5
7x5	5 3	18x18 (1/2-shee)	12 10
		36x18	21 3 0

7 lbs. £1 3 0 23 lbs. £4 0 0

No charge for cutting, waste or postage.

Delivery by return of post.

Quality A 1. DRILLING, manufacture—BRITISH
Thickness One Quarter : Surface Mat.

JAMES PORTLAND, 39, Sinclair Rd.,
Olympia, W.14

N.B.—Mr. Portland stocks 200
Wireless Parts.

"Daco" Steel Tapered Masts.

One-third the weight and twice as strong as ordinary tube masts.

PRICES COMPLETE WITH ALL FITTINGS.

20'	30'	40'	50'	60'
55/-	75/-	110/-	160/-	240/- each

E. HILL ALDAM & CO., LTD.,

93, STAMFORD STREET, LONDON, S.E.1.
(Agents Wanted).

TO THE TRADE

who desire to purchase apparatus of quality and high efficiency, the following manufacturers will be of interest :

Our Trade Terms are worth consideration. Complete Price List 4d.

Receiving Sets
Crystal and Valve.
Valve Panel Units.
Condensers.
Coil Holders
and other Accessories.

TWO SPECIAL LINES.

Headphones, 4,000 ohms, 22/- per pair.
Intervalve Transformers, 21/- each.

MILL HILL ENGINEERING WORKS
Edenbridge—Kent

REPRESENTATIVES.

District Travelling Representatives required by substantial wireless firm offering wireless sets at competitive prices. Those confident of obtaining good business should write stating qualifications and district covered. London not available, Commission basis.—Box B.Y.Z., BERTRAM DAY'S ADVERTISING OFFICES, 9 and 10, Charing Cross, S.W.1.

THE WIRELESS WORLD EXCHANGE AND MART

Greatest Bargain Ever Offered !



The Finest Quality.
Honestly worth 21s.

Wireless HEAD- PHONES



7s. 6d. per pair.
300 ohms 150 each.

Postage 6d. extra. Special Quotation for Quantities.
HYAMS, 25-26, King St., Camden Town, N.W.
Estab. 80 years.

Jacks 6s. doz. for
not less than 1 doz.
Phone 2832 North.

MISCELLANEOUS—continued.

The Proprietor of the Patent No. 139496 for improvements in or connected with receivers of high frequency sound waves is desirous of entering into arrangements by way of licence and otherwise on reasonable terms for the purpose of exploiting the same and ensuring its full development and practical working in this country. All communications should be addressed in the first instance to HASELTINE, LAKE & Co., Chartered Patent Agents, 28, Southampton Buildings, Chancery Lane, London, W.C.2.

The Proprietor of the Patent No. 139494 for improvements in or connected with multi-step thermionic amplifiers is desirous of entering into arrangements by way of licence and otherwise on reasonable terms for the purpose of exploiting the same and ensuring its full development and practical working in this country. All communications should be addressed in the first instance to HASELTINE, LAKE & Co., Chartered Patent Agents, 28, Southampton Buildings, Chancery Lane, London, W.C.2.

MISCELLANEOUS—continued.

The Proprietor of the Patent No. 139497 for improvements in or relating to electrically operated sound generators is desirous of entering into arrangements by way of licence and otherwise on reasonable terms for the purpose of exploiting the same and ensuring its full development and practical working in this country. All communications should be addressed in the first instance to HASELTINE, LAKE & Co., Chartered Patent Agents, 28, Southampton Buildings, Chancery Lane, London, W.C.2.

The Proprietor of the Patent No. 139498 for improvements in or connected with receivers for use in connection with signalling by sound waves is desirous of entering into arrangements by way of licence and otherwise on reasonable terms for the purpose of exploiting the same and ensuring its full development and practical working in this country. All communications should be addressed in the first instance to HASELTINE, LAKE & Co., Chartered Patent Agents, 28, Southampton Buildings, Chancery Lane, London, W.C.2.



PRICES
MOUNTED COMPLETE, FROM
5/-

Genuine Radcom Duolateral Inductance Coils

"DE FOREST PATENT"

These coils are designed to reduce the self capacity of a receiving inductance to a minimum.

**RADCOM RHEOSTATS, TUNERS, TRANSFORMERS
ACCUMULATORS.**

ORDERS VALUE £2, NOT EXCEEDING 11-LBS. WEIGHT, CARRIAGE PAID

Radio COMPONENTS LTD.

12/13, Henrietta St.,
LONDON, W.C.2

Telephone : Gerrard
792. Telegrams :
Radponents,
Rand. London.

Wanted! COPIES OF "THE WIRELESS WORLD"

:: :: for the following dates :: ::

Write stating price required.

VOL. V.—May, June, July, August, October, November, December, 1917; February, March, 1918.
VOL. VI.—April, May, September, 1918; February, March, 1919. VOL. IX.—August 6th.
and 20th; September 3rd and 17th, 1921. VOL. X.—May 13th and 20th, 1922.

Box L.H., Bertram Day & Co., Ltd. 9-10, Charing Cross, London, S.W.

THE ABC OF WIRELESS

By PERCY W. HARRIS

THE Book for the "Man in the Street."

Price **6d.** nett. Post free **8d.**

What is Wireless? How Does it Work?
THE "ABC" WILL TELL YOU.

THE WIRELESS PRESS, LTD.
12-13, HENRIETTA ST., LONDON, W.C.2

The Construction of Amateur Valve Stations

By ALAN L. M. DOUGLAS

78 pages. 55 Diagrams and Illustrations.

PRICE **1/6** NET.

(Postage 2d.)

THE WIRELESS PRESS, LIMITED
Depr. W.W.,
12-13 Henrietta Street, London, W.C.2.

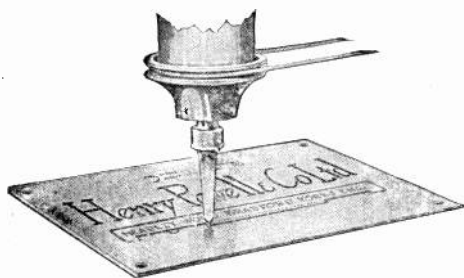

Cutter at Work.

Ebonite Panels

are engraved quickly and accurately by the Taylor-Hobson Engraving Machine.

It cuts letters and figures either sunk or in relief on almost any surface from soft wood to cast steel.

No modern Wireless Factory is complete without this machine.

Send for our latest catalogue.

TAYLOR, TAYLOR & HOBSON, LTD.

74a, Newman Street, London, W.1

Works : LEICESTER.

GENTS' "DISCOL" H.F. TRANSFORMER

HAS
BECOME
A



STANDARD
FITTING

We will send literature on receipt of p.c.

in the RADIO WORLD and is in large demand by every class of user.

Ask your Dealer for Gents' "Discol" H.F. Transformer

6/8 each

Also Gents' Tangent L.F. Transformer, 22/6 each.

GENT & CO., LTD. Radio Dept., Faraday Wks., LEICESTER

LONDON : 25, Victoria Street, S.W.1

NEWCASTLE-ON-TYNE : "Tangent House," Blackett Street.

CHELSEA STEEL MASTS

THE Chelsea hollow steel mast stands 30 feet high, is built in four sections, and is sold completely equipped for fixing.

The equipment includes :—
30 ft. Mast, painted battle-ship grey, sole plate, intermediate and top stay plates, 6 steel wire guy ropes, 3 2 ft. long iron earth pegs, 6 strainers, 12 S hooks, and 1 galvanised pulley block.

PRICE F. O. R.

£5 : 10 : 0

Prompt deliveries from stock. Trade supplied.

CHELSEA MOTOR BUILDING CO., LTD.

164, King's Road, Chelsea, S.W. 3.

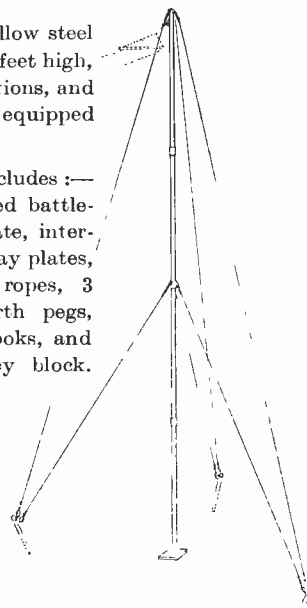

Just Published.

ACHIEVEMENTS & LIMITATIONS OF WIRELESS TELEGRAPHY

BY

L. B. TURNER, M.A., M.I.E.E.

18 Pages

17 Diagrams

PRICE **9^D** NETT.

(post free rod.)

This book is a reprint of a Lecture delivered at the S.M.E., Chatham, by Mr. Turner.

CONTENTS :

The Three Processes of Wireless Telegraphic Signalling. Radiation. Propagation. Wave Length Compromise. High Frequency Generators. Reception. Interference. Interference from other Stations. Atmospherics. Methods of Reducing Atmospheric Interference. Atmospheric Balancing. Atmospheric Limiting. Directive Reception.

The Wireless Press, Limited

DEPT. W.W.

12-13 Henrietta St., London, W.C.2

Alternating Current Work

By A. SHORE, A.M.I.E.E.

163 Pages.

86 Diagrams, etc.

This one small book embodies the main essentials of all the laws and formulæ of low frequency work which the student requires.

It explains in simple language the effect of inductance, capacity, and resonance, the formulæ being applicable to high and low frequency circuits.

A perusal of the contents will convince you that this is the very book for which you are looking.

SYNOPSIS OF CONTENTS.

Production and Laws of Alternating Currents; Alternating Current Generators; Rotary Converters; Power Measurements; Inductance, Reactance and Impedance; Condensers, Calculation of Capacity; Resonance. Natural Frequency; Ratio and Inductance of Transformers; High Frequency Resistance, the Skin Effect; Measuring Instruments, Moving Iron, Moving Coil, Hot Wire.

3/6

NETT.

Postage 4d.

The Wireless Press, Ltd.

12/13, Henrietta Street, London, W.C.2

The OHMER INSULATION TESTING SET (COX'S PATENT)

This is the lightest, cheapest and best instrument of its kind on the market. It consists of an Ohmeter and Generator mounted in one case. The Ohmeter is of the Electrostatic type, giving extreme lightness. Absolutely unaffected by external fields. It reads directly in Megohms and is independent of the voltage or speed of the generator.

NALDER BROS. & THOMPSON, LTD.,
 97a, DALSTON LANE, LONDON, E.8.



IF YOU WANT A
GOOD
 BOOK ON RADIOTELEPHONY
 GET
TELEPHONY
WITHOUT WIRES

BY
 PHILIP R. COURSEY, B.Sc. (ENG.), A.M.I.E.E.

Price **15/-** Nett
 (Postage 9d.)

It contains a complete collection of information on the various schemes, proposed and tried, relative to the electrical transmission of the sound of voices through space without wires.

An excellent list of references to papers and articles, forms a complete bibliography of the whole subject.

THE WIRELESS PRESS, LTD.
 Dept. W.W.
 12-13, Henrietta St., London, W.C.2

Revised and Enlarged Edition

AMATEURS This is just what you want
 THE VEST POCKET
DICTIONARY
 OF
TECHNICAL TERMS
 USED IN
WIRELESS WORK

By Harold Ward
 Over 1500 definitions

Price **2/6** net. Post free **2/9**

The Wireless Press, Limited
 Dept. W.W.
 12-13, Henrietta Street, Strand, London, W.C.2

Registered "NIPHAN" Trade Mark.

WATER-TIGHT PLUGS
and CABLE COUPLINGS
 TO MEET HOME OFFICE REQUIREMENTS



COUPLING CONNECTING CABLES

Phones:
 2600 Gerrard 12061 Central.

Telegrams:
 "Niphon, London."
 Patented in England and Abroad.

As used by H.M. War Office, Electric Supply Companies, Railway Companies, Marconi's Wireless Telegraph Company
SIMMONDS BROS., LTD.
 4, 6 & 8, NEWTON STREET, HOLBORN, W.C.



SIX WAY TEE CONNECTORS

28k dale

**ELWELL
High Power
Wireless
Stations**

Oxford

Cairo

Northolt

Horsea
Island

Eiffel
Tower

Lyons

Nantes

Rome

& others

**ELWELL
WIRELESS**

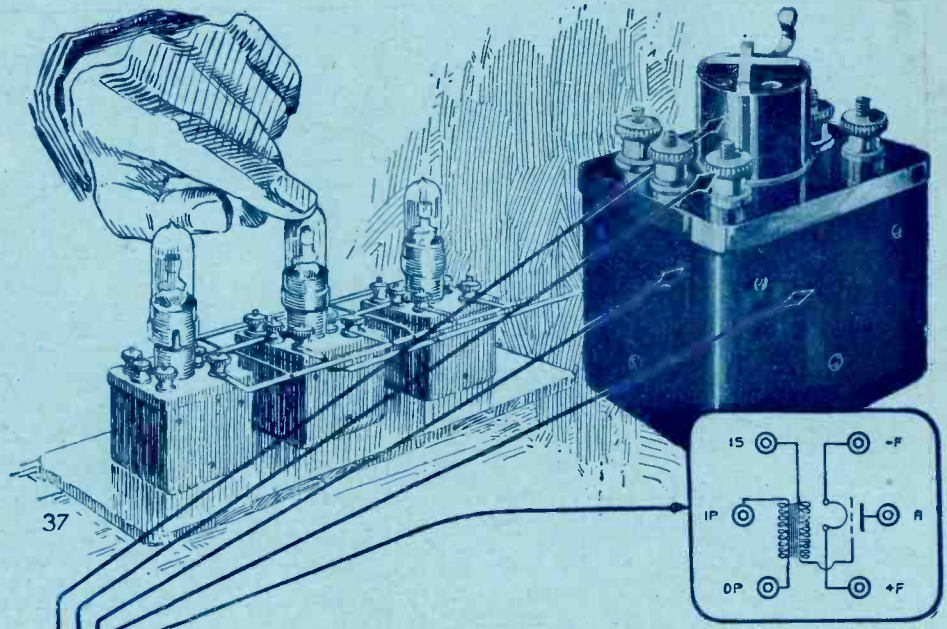

37

No need to spend time making these connections. The Elwell note magnifier contains them ready made.

The intervalve transformer is contained in an iron case allowing units to be placed close together without howling.

Tapped holes in two sides and base make fixing easy. The unit will also stand alone.

All connections are embedded in compound and brought out to terminals. No soldering necessary. The perfect insulation of the grid connection ensures silent operation.

The valve holder has specially long leakage paths and an earth clip.

Overall Dimensions:—3½" × 2 5/16" × 2".

This patented amplifying unit, when provided with a valve and connected as marked on the terminals, is all that is necessary to give one stage of note magnification to your existing set.

Two, three or more units may be coupled as shown, to give as many stages of note magnification as required.

PRICE 39/6 each.

AMPLIFYING MADE EASY

When building a valve set, do not buy intervalve transformers. Use Elwell Amplifying Units. They save time, money and trouble.

When buying a valve set, select one using these units. They enable the manufacturer to give you a better job at a lower cost.

The unit featured is a note magnifier.

A similar design of unit is available as an oscillation amplifier and a third design as a rectifying unit.

Elwell Amplifying Units are entirely British made.

WRITE US OR CALL.

C. F. ELWELL, LTD., *Radio Engineers,*
CRAVEN HOUSE, KINGSWAY, LONDON, W.C.2

Telephone: **REGENT 421.**

WIRELESS WORLD

AND

RADIO REVIEW

No. 174. [No. 11. VOL. XI.]

16th DECEMBER, 1922.

Registered at the G.P.O. as a Weekly Newspaper.



A FULL RANGE

OF

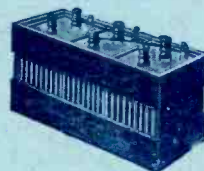

HART

HIGH AND LOW TENSION

BATTERIES

INCLUDING VARIOUS NEW TYPES SUITABLE FOR

WIRELESS SYSTEMS



HART ACCUMULATOR CO., LTD.,
STRATFORD LONDON, E.15

BRANCHES (BELFAST, BIRMINGHAM, BRISTOL, GLASGOW
MANCHESTER, WESTMINSTER & YORK.

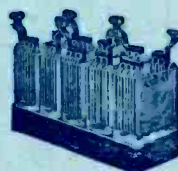



STERLING No. 1 CRYSTAL RECEIVING SET

Specially designed for use in connection with the Wireless Telephony Broadcasting Scheme, and is suitable for a range of about 25 miles.

PRICE £7-12-6

TO BE OBTAINED FROM ALL DEALERS OR DIRECT FROM:-

STERLING TELEPHONE & ELECTRIC CO., LTD.

210-212, Tottenham Court Road, LONDON : : : W.1

Telephone No. : 4144 Museum (7 lines)

Telegrams : "Cucumis, Wesdo, London."

Works : DAGENHAM, ESSEX.

BRANCHES:

NEWCASTLE-ON-TYNE : 9, Clavering Place.

CARDIFF : 8, Park Place.

We guarantee that all Broadcast Radio Apparatus sold by us conforms with the conditions of the Broadcaster's Licence issued by the P.M.G.

IMMEDIATE DELIVERY

"Wireless for all"

Before you decide on the construction of your set. It will pay you to have particulars of—

Condensite Celoron

For PANELS and OTHER PARTS.

This material is waterproof, immune to atmospheric and climatic conditions, will not warp, has high surface and volume resistivity, high di-electric strength, low specific gravity.

LET US QUOTE YOU

SEND PARTICULARS OF YOUR EXACT REQUIREMENTS TO

THE MANUFACTURERS

DIAMOND FIBRE CO. LTD.

DIAMOND-FIBRE WORKS

HIGH ROAD SOUTH TOTTENHAM, N.15.



RECEIVERS

The instruments advertised on this page are BROADCAST RECEIVING instruments which have been approved by the Postmaster-General and given registered numbers. They bear the seal of the British Broadcasting Company, and may be used under the Broadcast Receiving Licence, which can be obtained at any Post Office. Every instrument is thoroughly tested and guaranteed scientifically perfect, efficient in operation and entirely British.

G.P.O.
Regd.
No.
1098.

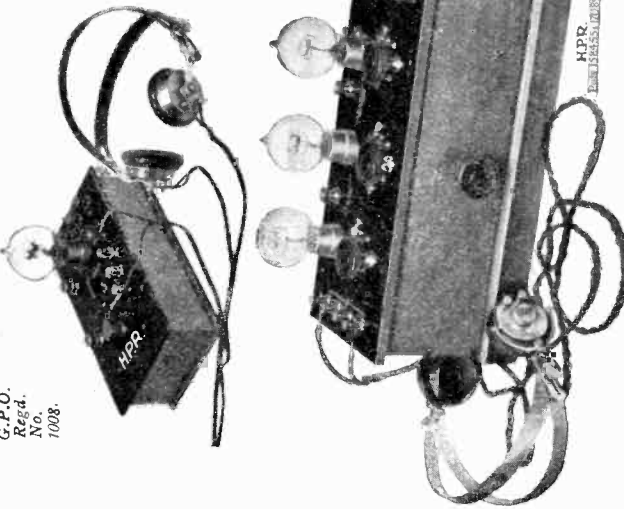

SIMPLEX WIRELESS 'PHONE

The "Simplex" Single Valve Wireless 'Phone has been so constructed that it can be operated without any knowledge of wireless. The connections to the batteries are simplified by a simple colour scheme. The instrument gives perfect rendition of Broadcast Music and Telephony. Note magnifiers may be added, making a two or three-valve 'phone. Price (without accessories) **£5 5s.**

H.T. battery, and aerial **£10 15s.**
(Plus the charge of £1 made by the British Broadcasting Company, Ltd.)

HILOPHONE THREE-VALVE SET

(One Detector, 1 H.F., 1 L.F. Valves.)

An ideal three-valve set, specially designed to pick up broadcasting in any part of Great Britain, amateurs, ships, etc. Fitted with the famous H.P.R. Patent Automatic Wavelength Indicator. Price (without accessories) **£19 19s.**
H.T. battery, and aerial **£29**
(Plus the charge of £2 5s. made by the British Broadcasting Co., Ltd.) G.P.O. Regd. No. 0113.

TRADE ENQUIRIES INVITED

Full particulars of these and other instruments of convenience for expert and novice may be had upon application H.P.R. Instruments may be obtained from Messrs. Hamley Bros., Negretti & Zambra, Civil Service Co-Operative Society, Ltd., Shoobred's Ltd., Army & Navy Co-Operative Society, Ltd., Seltridge & Co., Ltd., and J. John Ward (No. 6 Strand), and from all leading dealers in the provinces.

H.P.R. WIRELESS, LTD.

Pioneer Designers & Makers of Fine Valve Receiving Instruments for Amateurs.

Head Office and Demonstration Room:

CARLTON HOUSE, GT. QUEEN ST., KINGSWAY LONDON, W.C.2.

(Opposite Kingsway Theatre.)

H.P.R. Patent Automatic Wavelength Indicator, which is fitted to the Hilophone, has been called "the Indispensable Guide to the Ether." A leading wireless authority says: "It makes finding a station as easy as turning on the electric light."

"Castaphone" Apparatus for Broadcast Reception

Reg. Trad. Mark

Approved by P.M.G. under seal and registered number.

"Castaphone" Crystal Receiver, G.P.O. Reg. No. 167

"Castaphone" T.I., G.P.O. Reg. No. 1017



Wavelength range 300-500 metres.

A specially sensitive Crystal Receiver, Range 20-30 miles. A simple and effective instrument. Price £3 5s. Phones for above from 30/-

Prices include Broadcasting Commission and Marconi Royalty.

Castaphone sets are not designed to compete with cheap apparatus which must be unsatisfactory in use.

They represent a standard in design, workmanship and results, that cannot be bettered.

"Castagnoli" valve apparatus are made under Marconi license.

Write for full details.

TRADE ENQUIRIES INVITED.

GORDON CASTAGNOLI, A.M.I.R.E. MANUFACTURER OF WIRELESS APPARATUS **Braintree, Essex**



Wavelength range 300-500 metres.

"Castaphone" T.I. The most efficient one-valve set made. Effective range, 30-40 miles, and the most simple to work. Price £5 15s. less valve, or with phones, Marconi valve, batteries, and aerial wire and insulators, price £10 15s.



TYPE F. "Featherweight."
Actual weight, including cords,
is 6ozs. only.

BROWN'S

"Featherweight"

HEADPHONES

British and Best

The Finest Headphones Procurable for

30/-

This price is for one pair of either 120 or 4000 ohm 'phones, including cords of good quality.

Catalogue Post Free.

Head Office and
Works:
Victoria Road,
North Acton. W.3

S. G. BROWN, Ltd.

London
Showrooms:
19 Mortimer St.,
London, W.1

BURNDEPT

WIRELESS APPARATUS

The Daily Mail

U.S. WIRELESS CONCERT. HEARD IN ENGLAND.

THE
ON

For the first time on record a wireless concert broadcast from the United States has been heard in England. Mr. Frank Phillips, chief engineer of Messrs. Burndept, Ltd., wireless engineers, of Blackheath, S.E., told a *Daily Mail* reporter last night:

"About 1.15 this morning (Monday) our chief test-room operator, Mr. J. H. Ridley, was tuning up an apparatus at his house in Croydon, hoping to pick up test Morse signals sent out by amateurs in the United States.

"He was surprised to hear strains of distant music, together with the call No. W.J.Z. repeated several times. W.J.Z. is the call number of the Newark, New Jersey, U.S.A., wireless station. [Newark is 3,750 miles from London.]

T.
th
ec

"For more than an hour," Mr. Ridley says, "the concert continued and he was able to hear every item of it. An overture by Chopin was among the things played. The wave-length used was 325 metres, which we know is the wave-length used by the Newark station."

nt
he

While listening-in Mr. Ridley heard no fewer than nine American amateur stations calling to one another. The most distant station he heard was Chicago (4,652 miles from London).

HEARDING BEATEN

BURNDEPT Scores Again.

The Burndept H.F. Amplifier Mk. 1 for the Experimenter.

THIS is an additional radio frequency amplifying unit designed for use in front of the Burndept III, Burndept Ultra IV, or Burndept H.F. I. It is not intended for use in connection with other receivers as the scheme of connections is arranged to suit the above named instruments only, and is such that a potentiometer contained in this unit controls the grids of BOTH radio frequency valves.

If YOU own a Burndept III, Ultra IV, or H.F. I, purchase this new unit and hear signals you never heard before — even American amateurs if you are lucky—Ridley heard them with precisely this combination.

No. 107. In flat polished case
£12 A

No. 107s. In sloping cabinet
£13 A

Write for our Fully Illustrated Catalogue, price 1/-.

All **BURNDEPT** Valve Apparatus is duly licensed under Marconi Patents for Amateur use in Great Britain.

BURNDEPT, LTD., London Office & Showrooms: 15, Bedford Street, Strand, W.C.2
 City Showrooms: 79, Mark Lane, E.C.
 Exchange Buildings, 133, New Street, BIRMINGHAM.
 Aerial and Eastnor Works, BLACKHEATH, S.E.3
 93, Holm Street, GLASGOW.
 London Assurance House, Bond Place, LEEDS.
 Midland Bank Chambers, YEOVIL.
 61, Bridge Street, MANCHESTER.

Laboratories and Factories :
King's Rd., St. Pancras,
LONDON.

ANODE All communications to Reg. Offices :
265, STRAND, W.C.2
Tele. Nos. : City 4887, Cen. 8722

WIRELESS AND SCIENTIFIC INSTRUMENTS LTD.
Members of the British Broadcasting Company

The Set with a BIG REPUTATION

To the 'People of LONDON, MANCHESTER and BIRMINGHAM,
Broadcasting in your town is now in full swing.

The Anode **POPULAR SINGLE VALVE SET** is all you require.

Price £7 : 10 : 0

(Valve Phones and Batteries Extra)

NOTE GREAT WAVELENGTH RANGE. **350** to **600** metres and **2000** to **3600** metres.
FOUR SETS OF HEADPHONES MAY BE USED ON THIS INSTRUMENT.

Satisfaction Guaranteed. Send Cash with Order. Immediate Delivery from Stock.

Manufacturers to Post Office design of Receiving Sets now in operation at "Leafield," "Cairo," "Northolt," etc.

NOW is the Time to Order. Your Final Choice. Why Not Your First?
Trade Enquiries Invited.

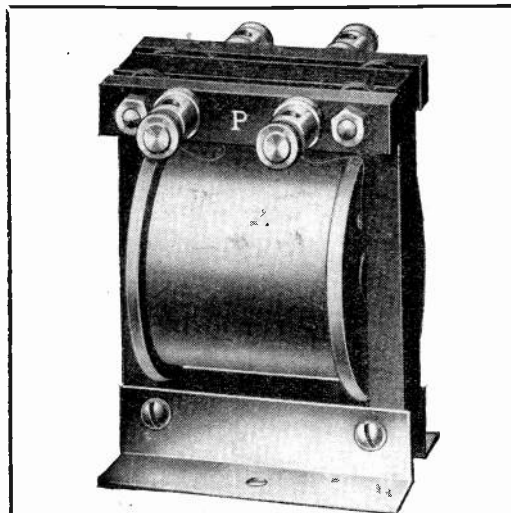

Interval Transformers wound with D.S.C. Copper Wire.
No. 244. Best quality 21/-
No. 245. Cheaper quality 15/-
Rigid Basket Coils, wound on former with Ebonite centre and
Brass Sockets for plug connection.
Set of 5 Coils (220-1200 metres) 10/6
Special Tuning Stand for use with above 12/-

MANUFACTURED BY
REYNOLDS & BRADWELL,
41, Church Street, Birmingham.

We Reply by Return

CRYSTAL DETECTOR

Lacquered Brass on Ebonite,
Ball and Socket movement.
Suitable for Silicon, Galena, etc.

PRICE **3/-** POST FREE

Two Cup Pattern for Zincite,
Bornite, etc. Lacquered Brass
on Ebonite **3/6** post free.

Complete Wireless Lists post free

Electrical Supply Stores,

5, Albert Terrace, King Cross, Halifax.

*Our money back guarantee accompanies
ALL our goods.*

TO TEST YOUR HIGH TENSION BATTERY YOU MUST USE A HIGH RESISTANCE VOLTMETER

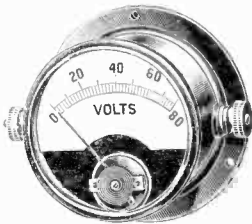

Moving Coil Type
2½ inch dial

We have designed a suitable instrument, to read to 80 volts.

Can be supplied in polished brass or nickelled case

Price 45/6 each

POST FREE. CASH WITH ORDER

WHITE ELECTRICAL INSTRUMENT CO. LTD.

2, 4 and 6, Gloucester Street, Clerkenwell, London, E.C.1

Telegrams : Voltograph, London.

Phone : City 8660.

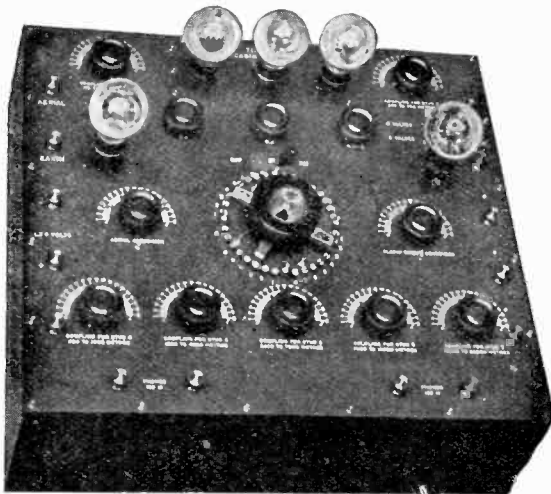

(REGISTERED DESIGN)

TINGEY UNIVERSAL RECEIVER

All "Tingey" Valve Apparatus is duly licensed under Marconi Patents for Amateur use in Great Britain.

Offices and Showrooms :
92, Queen Street, Hammersmith,
London, W.6.

Offices and Works :
Phone—HAMMERSMITH 1916
Telegs.—"TINGOIDAR LONDON."

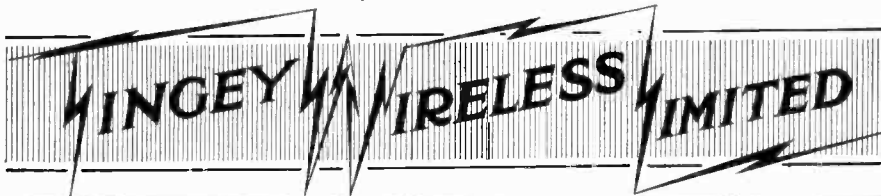

The First Two Text-Books for the Beginner

PRICE **6/-** NET

MAGNETISM & ELECTRICITY for HOME STUDY

By HAROLD E. PENROSE

515 Pages

224 Diagrams and Illustrations

A HEADMASTER'S OPINION.

The lucid way in which the author puts the matter before the reader; the sequence followed (proceeding from the known to the unknown); the numerous analogies and associations with ordinary everyday things; and the excellent sketches and diagrams, together with test questions and summaries, make the work admirable for self study or as a book for school use.

POST FREE **6/6**

PRICE **4/-** PER PART

7/6 COMBINED VOL.

THE ELEMENTARY PRINCIPLES of WIRELESS TELEGRAPHY

By R. D. BANGAY

Part I: 212 Pages

Part II: 241 Pages

If you have a Wireless Set and know but little of the principles of its working, you are missing a great amount of the interest and pleasure which the man obtains who has this knowledge.

This book tells in the simplest possible manner, the theory and practice of wireless.

The author makes the subject intelligible to persons who do not possess much technical knowledge, and at the same time is brief and accurate.

POST FREE

4/5 PER PART

8/3 COMBINED VOL.

THE WIRELESS PRESS, LIMITED,
12-13, Henrietta Street, Strand, London, W.C.2

DIRECTION AND POSITION FINDING BY WIRELESS

Price
9/-
Nett

By R. KEEN
B.Eng. (Hons.) Sheffield, A.M.I.E.E.
Demy 8vo. 363 Pages
Over 250 Photographs and Diagrams

Post
9/9
Free

This book deals not only with the principles of the subject but with the constructional details of Direction Finding Installations.

It describes the principles of Direction and Position Finding in this country in such a way that the subject may be grasped easily by engineers tackling this field of wireless work for the first time.

CONTENTS.

The Theory of the Wireless Direction Finder ; Valve Amplifiers and Detectors ;
Maps ; Position Finding ; Night Effect and other Freak Phenomena ;
The Shore D.F. Station ; The Ship D.F. Station ; The Aircraft
D.F. Station ; Fault Clearing and Maintenance ; Notes
on Field and Nautical Astronomy ; Bibliography.

The Wireless Press, Ltd.
12-13, Henrietta Street,
London, W.C.2

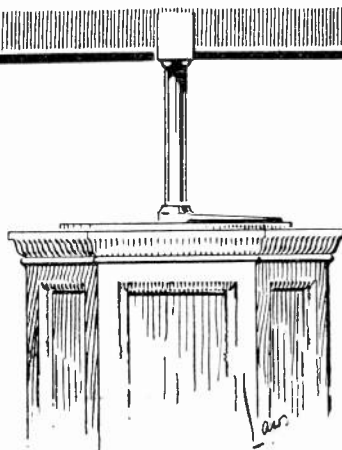

DUTCH CONCERTS

ON A
HOME MADE
2 VALVE SET
THIS IS WHAT

CONQUEST

OFFERS YOU
IN THE JANUARY ISSUE.

Price 1/- net. Post free 1/3

Full working details with "fool proof" diagrams and illustrations of how to make this set are given.

Granted that it's not the smartest looking set made, but it works, and works well, too.

This is not a theoretical set; it's practical; it's been tried and proved to be

AN ABSOLUTE SUCCESS

This one constructional article alone is worth more than the shilling charged for the magazine.

Get the January number which will be published on December 20th.

IT WILL PAY YOU

CONQUEST

The Magazine of Popular Science,
12/13 Henrietta Street, London, W.C.2

NOW READY

BINDING CASES

VOL. X.

The
**Wireless World
& Radio Review**

(INCLUDING INDEX)

Price **2/6** nett.

(Post free 2/11.)

INDEX (IF PURCHASED SEPARATELY)

Price **8d.** Post free.

A limited number only of
COMPLETE BOUND VOL. X

(April—September, 1922)

Price **25/-** nett.

(Post free 26/-)

For the benefit of those of our readers who desire to have their parts bound, we shall be glad to undertake this for them upon receipt of the copies and remittance of 8/6 which includes cost of Binding Case, Index and return postage.

The WIRELESSPRESS Ltd.

12-13, Henrietta St., London, W.C.2

W. MACKIE & CO.

(ESTABLISHED 1882.)

Works: THE PALACE ENGINEERING WORKS,
129, 131, 133, Lambeth Road, London, S.E.1.

Central Office: Sardinia House, Kingsway, London, W.C.2.

Telephone Nos.: Works—Hop 182.

Central Office—Holborn 2125.

*Manufacturers of Wireless Generators to the
Admiralty, War Office, and Air Force,
Marconi's Wireless Telegraph Co., Ltd., &c.*

HAVE just placed on the market the latest machine for Wireless users. Specially constructed for silence in Wireless Transmission.

80^{Watt} Rotary Transformer

L.T. 11 Volts 13·9 Amps.

H.T. 1150 Volts ·073 Amps.

SUITABLE FOR ALL WIRELESS ENGINEERS.

INSPECTION INVITED.

ENQUIRIES SOLICITED.

Doing away with the aerial

THE "DUCON"

Where there is electric light, an aerial is unnecessary. Plug a "Ducon" into an ordinary lamp holder or wall socket, connect to the wireless receiver and you will receive the broadcasting perfectly.

The set is quiet, there is no noise from the mains, and the "Ducon" is perfectly safe to use, consumes no current and does not affect the electric light in any way.

The "Ducon" gives satisfactory results with all types of receivers, from crystal to multi-valve.

The DUCON 10%

is obtainable from all leading wireless dealers, electrical contractors and stores, or direct from the makers.

Dealers not yet stocking are invited to write for trade terms.

Over 50,000 in use.

THE DUBILIER CONDENSER CO. (1921) LTD.,
Ducon Works, Goldhawk Road, Shepherd's Bush, London, W.12.
Telephone—Hammersmith 1084. Telegrams—"Hivolcon, Phone, London."

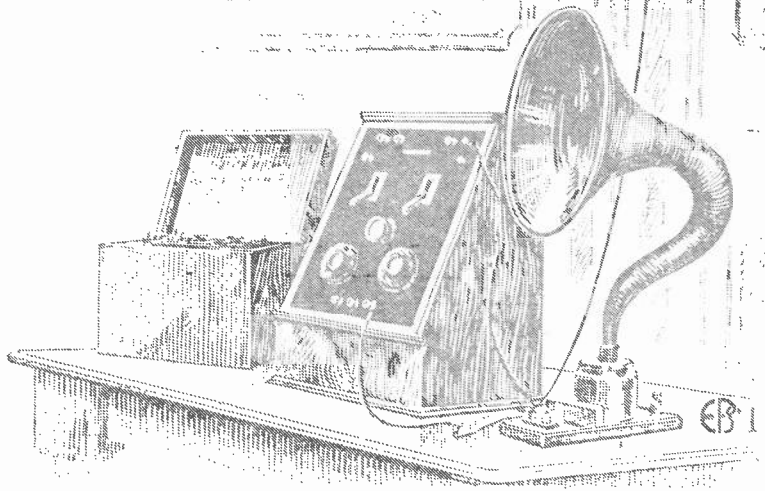
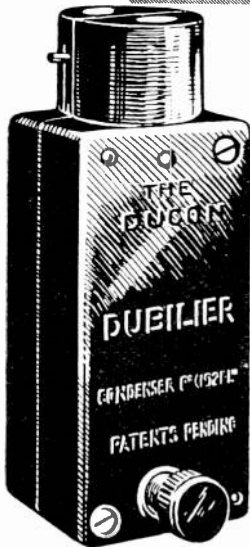

Agent:
F. ESCOTT,
23, High St.,
Hampstead.

Introducing the
AUDIOPHONE
a Broadcast Receiver of MERIT

Agent:
J. T. HARTWELL,
5, West Chapel St.,
Mayfair, W.1.

Efficient.

Specification.-1.

Manufactured, assembled and finished by highly skilled hand labour throughout. Bare, tinned internal wiring, bent on formers, and soldered at all connections, thus ensuring a noiseless circuit.

IMPORTANT:
Fixed Reaction
is a Feature of
this Receiver.

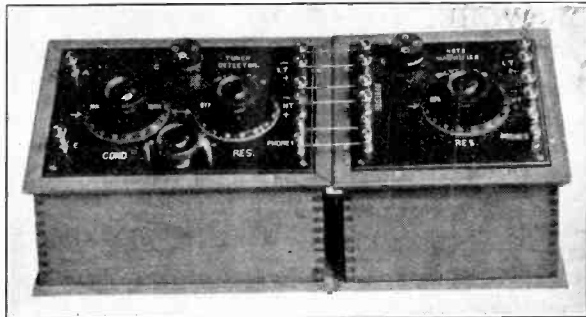

TUNER DETECTOR.

Price as shown **£7 : 7 : 0**
Complete with:—Siemens 60 v. H.T.
4 v. 50 amp. (actual) L.T., and M.O.
Valve R. Type **£11 : 12 : 0**
Prices include Marconi Royalty and commission to B.B.C.
P.M.G. Reg. No. 1018.

NOTE MAGNIFIER.

Price **£4 : 5 : 0**
Complete with:—Marconi
Osram R. Type Valve
. **£5 : 2 : 6**
P.M.G. No. 3015.

Highly Sensitive.

EMPLOYING THE
UNIT SYSTEM.

Specification.-2.

Polished ebonite panel, engraved white, functions of all knobs and terminals clearly indicated. The whole mounted in desk style polished mahogany cabinet. Wave-length range 300-550 m. Higher wavelengths obtained by means of plug-in coils.

Fully approved by
H. M. Postmaster-
General.

TERMS:—Cash with order, or instruments on five days approval against full deposit.

Manufactured under Marconi Licence by **J. R. WRIGHT**, 10, Carton St., Baker St., W.1.

A Broadcasting Receiving Set
of Exceptional Merit—

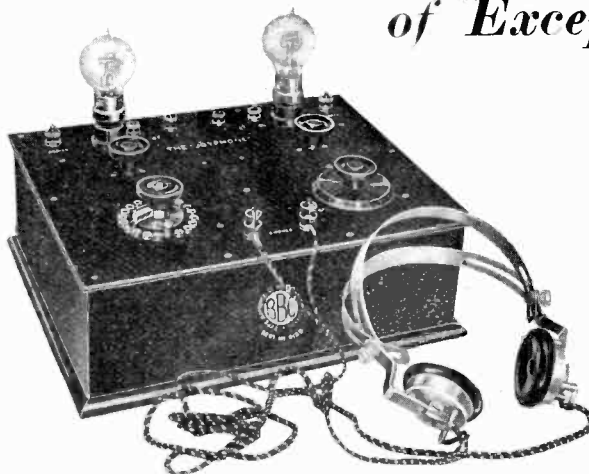

The JOYPHONE

(Reg. No. 0138.)

2 Valve Set Complete.

Is made of the finest materials and workmanship throughout, beautifully finished and thoroughly efficient.

Price £15 Complete.

Fully Guaranteed,

including all accessories and covered by B.B.C. authority.

This is a COMPLETE Set; no further accessories are required and no additional expense necessary.

You are cordially invited to call any evening and hear the daily Broadcasting received to perfection on the "JOYPHONE."

All valve apparatus duly licensed under Marconi patents for amateur use in Great Britain. Approved by Postmaster-General.

We can install the "Joyphone" for you at a very small extra cost.

J. LIPOWSKY & Co. Electrical & Wireless Engineers.
614, OLD FORD ROAD, BOW, LONDON, E. 3. (Near Old Ford Station, N.L.Ry.)

Telephone: East 3345.

No. 8 or 39 'Bus.

TONS

of EBONITE SHEET in Stock
for immediate delivery in quantities
suitable for all classes of
WIRELESS WORK.

SHEETS - RODS TUBES - PANELS

TUBES and ROTORS for Variometers.
MOULDED KNOBS (various patterns),
COMBINED DIALS AND KNOBS,
3", 3½" and 4" diameters.
Do. for Fil. Res. and Vario-Couplers.
AERIAL INSULATORS.

Wholesale only.

AMERICAN HARD RUBBER
COMPANY (Britain) LIMITED,
13a, Fore Street, London, E. C.
Teleg. "Eboniseth, Ave., London." Phone; Central 12754.



TRADE MARK

**The WHITECROSS
COMPANY, LIMITED
:: WARRINGTON ::**
Manufacturers of All Descriptions of
**WIRE ROPES
AND WIRES**

DRY BATTERIES

FOR

WIRELESS

AND

OTHER PURPOSES.



REG. TRADE MARK

SEE THAT THEY BEAR THIS
TRADE MARK.

Descriptive pamphlet and prices on application to
THE MANUFACTURERS:

SIEMENS BROTHERS & Co. LTD.

General Offices & Works:

WOOLWICH, LONDON, S.E.18

Telegrams :
SIEMENS, WOOLWICH.

Telephone :
CITY 6400 (7 lines).

And at

Belfast, Birmingham, Bristol, Cardiff, Glasgow,
Leeds, Manchester Newcastle, Sheffield, Southampton.

<p>P. ORMISTON & SONS (P. H. ORMISTON) :: ESTABLISHED 1793 79 Clerkenwell Rd., London, E.C.1 "Ormiston, London." :: :: 13259 Central.</p>	<p>Silk and Cotton Covered H.C. Copper Wire, Resistance Wires, Fuse Wire, Binding Wires, Charcoal Iron Core Wire, Asbestos Covered Wire, Braided and Twisted Wires, Bare Copper Strand and Flexibles of any Construction, Wire Ropes, and Cords (fine sizes) in Galvanized Steel, Phosphor Bronze, &c.</p>
---	--

THE WIRELESS WORLD AND RADIO REVIEW

THE OFFICIAL ORGAN OF THE RADIO SOCIETY OF GREAT BRITAIN
A MAGAZINE DEVOTED TO WIRELESS TELEGRAPHY AND TELEPHONY

CONTENTS

The Birmingham Broadcasting Station. By E. M. Deloraine, Ing. E.P.C.I. - - -	357
A Receiver-Amplifier for Short Waves. By Adrian B. Jones - - -	361
Electrons, Electric Waves and Wireless Telephony. By Dr. J. A. Fleming, F.R.S. - -	364
Radio Society of Great Britain : Discussion - - - - -	371

Contents continued on next page.

Ediswan Valves.

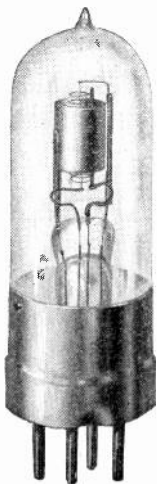

Type AR

THE manufacture of Thermionic Valves is a highly skilled operation and every Ediswan Valve has behind it the experience and operative skill of over forty years of lamp making.

The AR Valve illustrated is specially made for Amateur reception. Plate voltage 30-80 volts. Filament volts 3.5-6.0 volts. Filament current 0.75 amperes. High amplification—silent working.

Price 15/- each.

Always ask for Ediswan Valves. If you are unable to obtain them at your Dealers write to us for the name and address of the nearest supplier.

THE EDISON SWAN ELECTRIC CO., LTD.

Head Office: 123/5, QUEEN VICTORIA STREET, E.C.4.

*London Showrooms: 123/5, Queen Victoria Street, E.C.4, & 71, Victoria Street, S.W.1.
Works: Ponders End, Middlesex.*

STALLOY **TRANSFORMER LAMINATIONS**
 SOLE MANUFACTURERS **JOSEPH SANKEY & SONS LTD** AND SUPPLIERS
 WORKS: BILSTON, STAFFS. London Office: 168 REGENT ST. W.1
TELEPHONE RECEIVER DIAPHRAGMS

CONTENTS (Continued)

Wireless Club Reports	- - - - -	373
Notes	- - - - -	378
Correspondence	- - - - -	379
The Transatlantic Tests	- - - - -	380
Calendar of Current Events	- - - - -	382
Questions and Answers	- - - - -	383
Share Market Report	- - - - -	388

THE WIRELESS WORLD AND RADIO REVIEW is published weekly on Saturdays.

All correspondence relating to contributions should be addressed to THE EDITOR, THE WIRELESS WORLD AND RADIO REVIEW, 12-13, Henrietta Street, Strand, London, W.C.2.

No responsibility can be taken for MSS. or photographs sent without stamps to defray cost of return postage.

Editorial and Publishing Offices : 12-13, Henrietta Street, Strand, London, W.C.2.

Telegraphic Address : "Radionic, Rand, London." Telephone No. : Gerrard 2807.

Advertisement Managers, Bertram Day & Co., Ltd., 9 and 10, Charing Cross, S.W.1.

Telephone No. : Gerrard 8063 and 8064.

SUBSCRIPTION RATES.

28s. per annum, post free. Single Copies 6d., or post free 7d.

Registered at the G.P.O. for transmission by Magazine Post to Canada and Newfoundland.

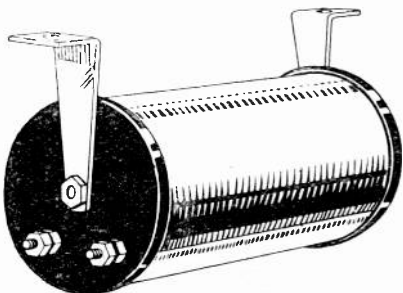

HERE IS A GOOD TRANSFORMER.

Intended for the serious experimenter, no other Intervalve Transformer has such an expensive coil. Statically and Magnetically Screened, it is mounted in brass case, finished dull black. Very easy to fix, with plenty of clearance space. May be used side by side with absolute silence and absence of interaction. With this transformer used in multiples your three valves will give the results of four valves. Price is 30/-. Order direct and, if possible, give name of usual wireless dealer. TRADERS desiring to see samples of LISSEN PRODUCTS manufactured throughout in our own works, should apply on trade heading.

Dealers desiring to sell Lissen Products should write to us.

LISSEN COMPANY, 35, Oxford Street, London, W.1

"LET'S LISSEN-IN." Works—HAMMERSMITH.

To the
Discriminating
Experimenter.

A New Filament Resistance

Holders of experimental licences who make their own apparatus are naturally anxious to obtain the highest possible efficiency in every component part. To meet the requirements of the discriminating experimenter the Marconi Scientific Instrument Company, Ltd., are now selling a line of high-grade component parts of the same quality as those used in their own justly famed "Units." As an example, the Marconi filament rheostat illustrated herewith possesses a number of features which make it unique.

Firstly, the resistance wire is heavy enough to carry current for three valves, if necessary, without overheating. The wire itself is wound on a grooved former. Contact is made by a heavy copper spiral which, when rotated by the knurled ebonite knob, moves smoothly from one end of the coil to the other. There are no "jumpy" places, no jolts and jars, and the movement throughout is as smooth as that of a good variable condenser. Contact between the former and the spiral is maintained by the spring shown.

This resistance is supplied ready for panel mounting with high-grade ebonite knob and pointer, together with fixing screws. Mounting is effected by drilling a central hole $\frac{3}{8}$ ths diameter, and three clearance holes for 4 B.A. metal screws. The brass support is supplied already threaded for these screws.

The price—12/6—is very reasonable compared with that charged for the ordinary type of rheostat. A potentiometer wound on exactly the same principle is sold for 15/-, the resistance being 300 ohms.

*The Marconi Scientific Instrument Co. Ltd.
The House for the Discriminating Experimenter.*

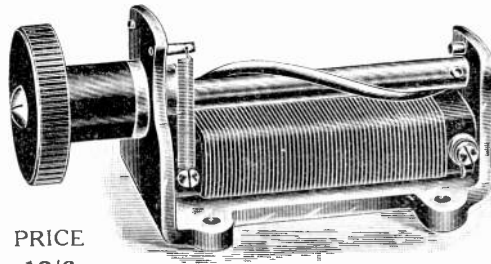

PRICE
12/6

Special Holders for V24 and QX Type Valves

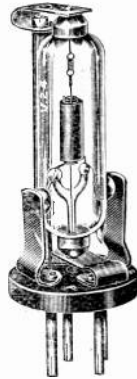

Type D.
PRICE
4/-

Many experimenters are anxious to try the V24 and QX valves in their own receivers. These valves are of tubular form, and are mounted in a manner different from that of the ordinary "four-pin" types. Both valves oscillate very readily on low anode voltages, and the former is very popular for separate oscillators. Both QX and V24 valves have a very low self capacity, and are therefore useful in short wave reception. The Marconi Scientific Instrument Company, Ltd., is now marketing adaptors which will enable these valves to be used in any four-pin socket. They are particularly recommended to those who have constructed heterodynes for either short or long wave work, as they enable very low anode voltages to be used.

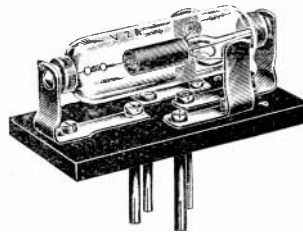

Type E. PRICE 3/6

Are you making wireless gifts for Christmas? Call at our Dean Street Show-rooms, and see the full range of components and complete sets.

The Marconi Scientific Instrument Co. Ltd.

Telegrams : *Themasinco, Westcent.* 40 Dean Street, Soho, W.1

Telephone : *Gerrard 7745.*

How did YOU receive the Election Results?

It can be confidently said that all who were listening in with a Wates Set were very pleased with the reception when the election results were broadcasted.

The reception was good—not only because Wates Sets are perfect in manufacture, but also because purchasers can avail themselves of the free advice of our technical experts, who can help them to get the best possible results under varying circumstances.

Not only do we manufacture complete Receiving Sets of the best quality, but also all component parts.

The illustration is that of the PYRAMID H.T. Battery, which we can confidently recommend to help you to get better results. It is priced as follows:—

Filament Resistances **3/9**
"Ideal" Valve Accumulator—

4-Volt 50 amp. - **25/-**
(Carriage 2/-)

6 ,, 50 amp. - **35/-**
(Carriage 3/-)

Variable Condensers
(of various capacities)
From **6/-**

Fixed Condensers. From **2/6**

3-Coil Holder, complete
Unit for use with
Standard Coils - - **20/-**

15-Volt 3/6

30-Volt 7/6

With variable plug
connection.

Send 3d. stamps for
our Illustrated
Catalogue.

List of
H.T. Batteries or
Accessories—Free.



WATES BROS., 13-14, Gt. Queen St., KINGSWAY, LONDON, W.C.2

Components & Materials

AERIAL WIRES, per 150' lengths, best quality only supplied. Phos bronze, 7/20, 10/-; 7/22, 6/-; 7/25, 4/6. Copper, 7/20, 9/6; 7/22, 5/8; 7/25, 4-. Postage, 9d., extra.

INSULATORS, porcelain "Reel" type, 2" diam., each 4d. "Egg" type, 4d. Type "A" shell, 1/-.

GRID LEAKS AND CONDENSERS, 4/-, 5/3, and 7/6.

ASH SPREADERS, 6' x 3/4" diam. Best selected wood free from cracks. 2/- each, carriage 6d.

LEAD-IN INSULATORS, 9" long, 2/6; 12" long, 3/- Ebonite insulation with brass rod fitted with terminal and soldering shoe.

SPECIAL SOLDER, entirely acid free. Needs no flux and only moderately hot iron. Specially made for wiring up switchboards and panels. Per foot, 4d.

INSULATING SLEEVING, all colours, per yard, 6d.

EBONITE KNOBS, plain or grooved top, 6d.

VARIOMETER FORMERS, for the "Armstrong Circuit," 7/- per set. Ready wound and fitted, 18/- Ditto for "Broadcasting Wavelengths," complete, 17/-.

FILAMENT RESISTANCE, for panel mounting, complete with knob, etc., 4/-.

TERMINALS, complete with nuts and washers, per doz., 3/-
CONTACT STUDS, with nut and washer. Head 1/4" x 1/4", per doz., 1/6.

PARAFFIN WAX, pure white, per lb., 1/6.

RUBBER FLEX, 14/36, 2d.; 23/36, 2 1/2d.; 54/36, 4d. per yard.

ALL YOUR REQUIREMENTS FROM STOCK.

RADIO SUPPLIES, 234 High Holborn.

*Phone, Holborn, 2188.

London, W.C.1.

**EBONITE AND
VULCANITE**

TUBES—RODS—SHEETS

**LARGE
STOCKS**

**BRITANNIA RUBBER AND
KAMPTULICON CO., LTD.**
7, NEWGATE ST., LONDON, E.C.1

Telephone :
2168 Central

Telegrams :
Britannia, London

THE WIRELESS WORLD AND RADIO REVIEW

THE OFFICIAL ORGAN OF THE RADIO SOCIETY OF GREAT BRITAIN

No. 174 [No. 11
VOL. XI.] DECEMBER 16TH, 1922.

WEEKLY

The Birmingham Broadcasting Station.

By E. M. DELORAINE, Ing.E.P.C.I.

IN a recent issue of *The Wireless World and Radio Review*, an announcement appeared to the effect that the Birmingham Broadcasting Station had started transmitting music, news, etc., on November 15th.

The radio equipment used has been designed and built by the Western Electric Co. It is for the present installed at the Witton Works of the General Electric Company, pending the selection of premises for the permanent station of the British Broadcasting Company in Birmingham.

The Western Electric Broadcasting Set is designed to deliver 500 watts of radio frequency power to the antenna. As there are some novel features in the design and

arrangement of this set, a general description of the present installation may be of interest.

POWER SUPPLY.

The power supply is obtained from a three-unit motor generator set consisting of high and low voltage D.C. generators, coupled to a driving motor. The three units are mounted on a common base-plate. (Shown to the left in Fig. 2.)

The main supply is 460 volts D.C.; an automatic starter is used, and provides for starting and stopping by the mere operation of a press button. The driving motor

develops 4 H.P. at a speed of 1,750 r.p.m.

The high voltage generator is a direct current shunt wound machine with two com-

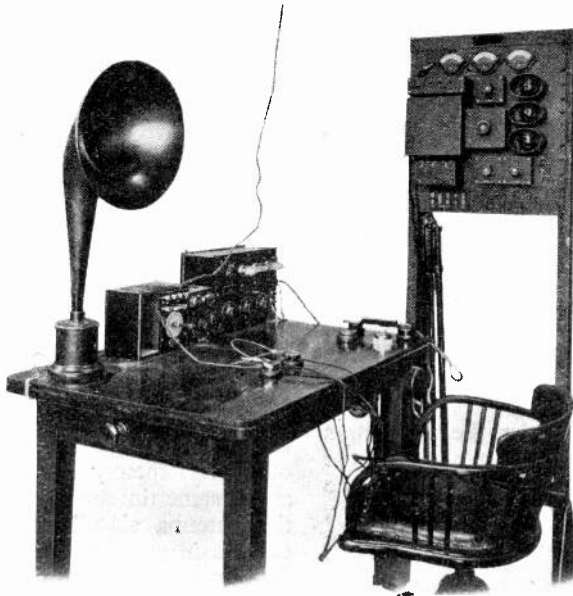

Fig. 1.

mutators designed to deliver continuously 1.25 amps. at 1,600 volts pressure. This is to supply the plate circuit of the transmitting valves. The field excitation current for the high voltage generator is supplied by the low voltage generator.

The low voltage generator is a direct current shunt wound machine, designed to deliver the filament current for the valves, *i.e.*, 28 amps at 14.5 volts pressure, plus the current for the excitation of the high voltage generator field. The low voltage generator is self-exciting and its potential is regulated by means of a field rheostat on the control panel. Both generators are designed so as to reduce to a

frequency energy, with means for modulating this energy in accordance with the complex sound vibrations, which are translated into suitable alternating electric currents by means of a microphone and an amplifier. The oscillator comprises a tuned circuit with variable inductance and capacity and the energy is transferred to the antenna by indirect magnetic coupling. Variations of potential in phase with the plate current variations are impressed on the grid on account of the magnetic coupling between the plate and grid coils, thus causing this circuit under proper conditions to act as a generator of sustained oscillations.

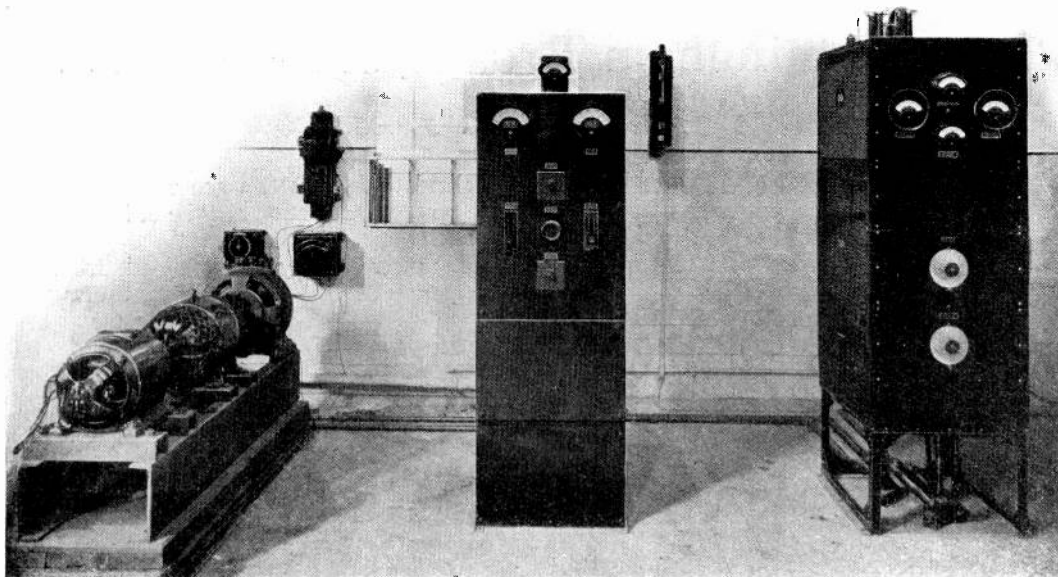

Fig. 2.

minimum the commutator noises in the radio transmission.

CONTROL PANEL.

The control panel includes the voltmeters for the low and high tension generators, the switches for controlling the field circuit of the high voltage generator, the plate current supply, and the filament current supply. (Centre Fig. 2.)

A circuit breaker is also included in the plate current supply and works with an overload of 25 per cent.

TRANSMITTING UNIT.

The transmitting unit (shown to the right in Fig. 2) is essentially a generator of radio-

The frequency of the carrier wave is controlled by the value of the capacity and inductance in the oscillatory circuit, and the value of the variable inductance in the antenna circuit. This inductance is adjusted by means of a variometer, the movable coil serving at the same time to vary the coupling between the antenna circuit and the grid and plate circuits in such a manner as to ensure satisfactory operation throughout the frequency range for which the set is designed.

The vacuum tubes used for transmitting make use of an oxide-coated filament and have been described in *The Wireless World and Radio Review* for November 4th. The tubes are supplied at 1,600 volts plate potential;

each of them is able to deliver 250 watts of high frequency power. The filament current required is 6.25 amperes. The tube works at "saturation temperature," thus the output is independent between certain limits of the filament current. The very large amount of emitted electrons ensures also symmetrical and faithful modulation.

The grid circuit of the tubes is given a negative potential by means of a resistance connected between the negative terminal of the 1,600 volts generator and the filaments to ensure that the tubes will operate under the conditions most favourable for the prevention of distortion.

The studio is situated in a quiet part of the building and has been made reasonably sound-proof, so as to exclude outside disturbances.

Proper placing of the performers is of the first importance. The distance between the artist and the microphone depends entirely upon the character of the voice or the instrument played, and considerable experience is required in order to obtain the best results. A speaker should stand from one to three feet from the microphone; in the case of singers or instrumentalists the question is much more complex.

A small switchboard is also installed in the studio and on this is mounted a switch for



Fig. 3.

The plates are fed through an electric filter, made of series inductances and condensers in shunt, to eliminate commutator noises.

STUDIO.

The microphone or transmitter is located in the "Studio" (Fig. 3), the acoustic properties of which are very important. It is arranged so as to be entirely free from echo effect, a result which is obtained by draping the walls, and sometimes also the ceiling, with non-reflective material. The actual amount of draping required is determined by experiment. At the same time the acoustic damping must not be too great or the musical tones picked up by the microphone will lack brilliancy.

The floor is covered with a thick carpet.

closing the final link in the microphone circuit. To facilitate the liaison between studio and apparatus room, a local telephone is installed, fitted with a lamp signal in the studio in place of a bell. When the radio set is ready for operation, in order to indicate in the studio that transmission may be commenced, the studio illumination is changed, warning those present that everything is in readiness, and that all conversation must cease. The change in illumination corresponds somewhat to the switching on of footlights in a regular theatre.

In view of the fact that the studio of a radio broadcasting station is really a stage upon which the artist appears, every sound

being transmitted, this room cannot be used as a reception room. A separate comfortably furnished room is provided for waiting artistes.

MICROPHONE AND SPEECH INPUT EQUIPMENT.

The microphone (shown on the stand in Fig. 3) is specially designed to give a faithful reproduction of speech and music. As stated in a previous article, the range of frequencies involved in music is much greater than the practical range of speech frequencies. The volume of efficiency of the microphone is low, and it is necessary to increase considerably the magnitude of the voice frequency current before it is impressed upon the radio transmitting set.

The speech input amplifier (Fig. 1) is shown, mounted on an iron frame, and consists of a three-stage amplifier with suitable control for the current in the microphone, and in the different filaments, and permits also of a variation in the degree of coupling between the different tubes, and therefore of the control of the amount of amplification. The filament

and microphonic currents are obtained from a storage battery with associated charging equipment.

To enable the operator to observe the loudness and quality of speech and music delivered to the radio transmitter, a loud speaking receiver, shown standing on the table in Fig. 1, is connected across the output terminals of the amplifier.

AERIAL.

The aerial is installed between the flag-staff pole of a building and a pole on the roof of an adjacent building 80 ft. above the ground; the length of aerial wire between insulators is 110 ft. The aerial is four-wire, L type, the distance between parallel wires being 6 ft.

The wavelength is 420 metres. The antenna current is between 9 and 10 amperes.

It is important that the antenna should be properly guyed to prevent swinging, which, by causing a variation in the capacity of the aerial to ground, might cause a variation in the wavelength transmitted.

It may be of interest to the signatories of the document here reproduced to learn that the troublesome transformer at last has been rewound and is doing good service on a London telephony transmitting station.

The transformer came into my possession through the usual channels by which I obtain most of my wireless equipment, having been picked up for a few shillings at a well-known London auction room.

A preliminary test revealed a faulty section, and on breaking up the high-tension winding, the crumpled and somewhat charred relic was found. The transformer has been renovated and commenced a new lease of life, the severed turns of wire that inter-

A War Relic

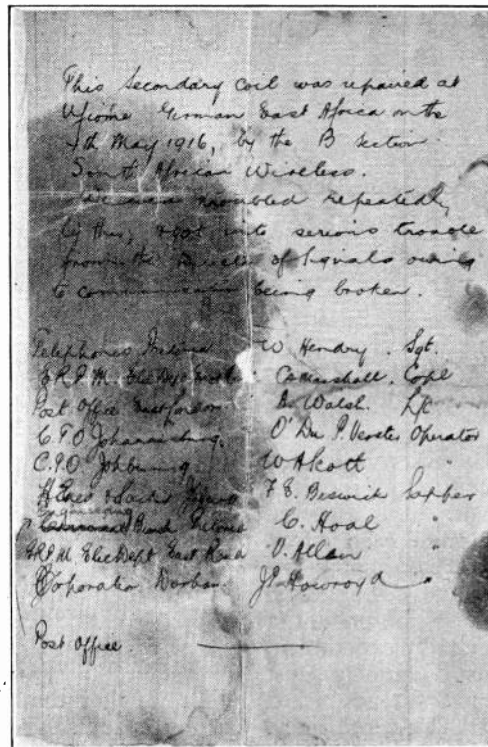

rupted communication in German East Africa having been thrown on the scrap-heap, and up to the present is working with entire satisfaction, and trying hard to redeem its past black record.

The document reads:

This Secondary coil was repaired at Ufiome, German East Africa, on the 4th May, 1916, by the B Section, South African Wireless. We were troubled repeatedly by this, and got into serious trouble from the Director of Signals owing to communication being broken.

And is signed by:—
 W. Hendry (Sgt.),
 C.A. Marshall (Corpl.),
 A. Walsh (L/C.),
 Operator O'Du P. Verster and W. A. Scott, and Sappers F. E. Beswick, C. Hoal, V. Allan, and J. P. Howroyd. 2 DY.

A Receiver-Amplifier for Short Waves.

By ADRIAN B. JONES.

NOT having the experience necessary for the design of a receiver which would work efficiently over such a range of frequencies as from 200 to 20,000 metres, as advertised in some periodicals, without the introduction of complicated dead-end switches or coil-changing devices, I decided to restrict myself to the limited range of 160 to 1,200 metre waves.

The receiver was to be able to deal with telephony of short wavelength, say 200 to 400 metres, to be as simple as possible, so that conversations could be followed, necessitating the number of variables to be as few as possible. Wavelengths of 600 metres, for ships, and 950 for local time signals and news messages, were also to be received.

My station is situated only 20 miles from Buenos Aires, from whence the majority of transmissions emanate, so I had not to allow for the reception of very weak signals. Am-

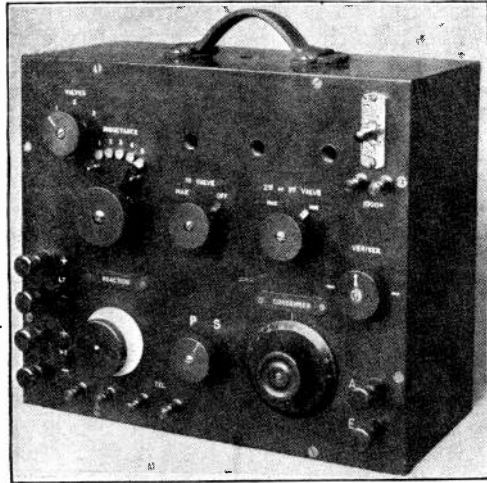

Photograph showing Controls. The instrument is easily portable.

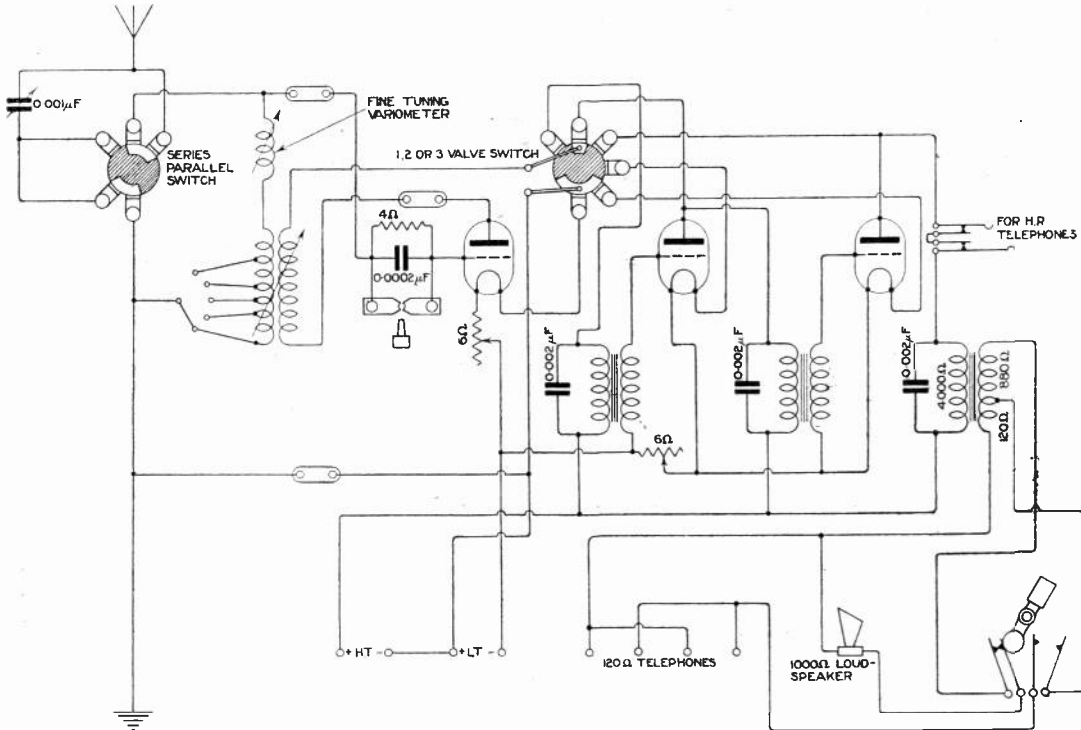

Circuit Diagram of the Short-Wave Receiver Amplifier.

plification would only be necessary when using a loud-speaker, or when several persons were listening with head-receivers. For the sake of simplicity, low-frequency amplification was resorted to, as over the fairly wide band of from 200 to 400 metres, high-frequency transformation is more involved.

The basic circuit is of the direct type with reaction, using regenerative amplification with grid current and leaky condenser rectification. This is not suitable for the reception

With regard to the type of tuning coil to use. I have tried concentric cylinders, cylinder and ball, and "spider web." The first has the curious effect that when the inside cylinder, usually the reactance, is moved out of the outer, the effect is as if one cylinder were attached to the other by an indiarubber strip, which at the critical point where reactance ceases, breaks. To produce reactance once more, one has to go a considerable distance back in order to pick up this broken strip,

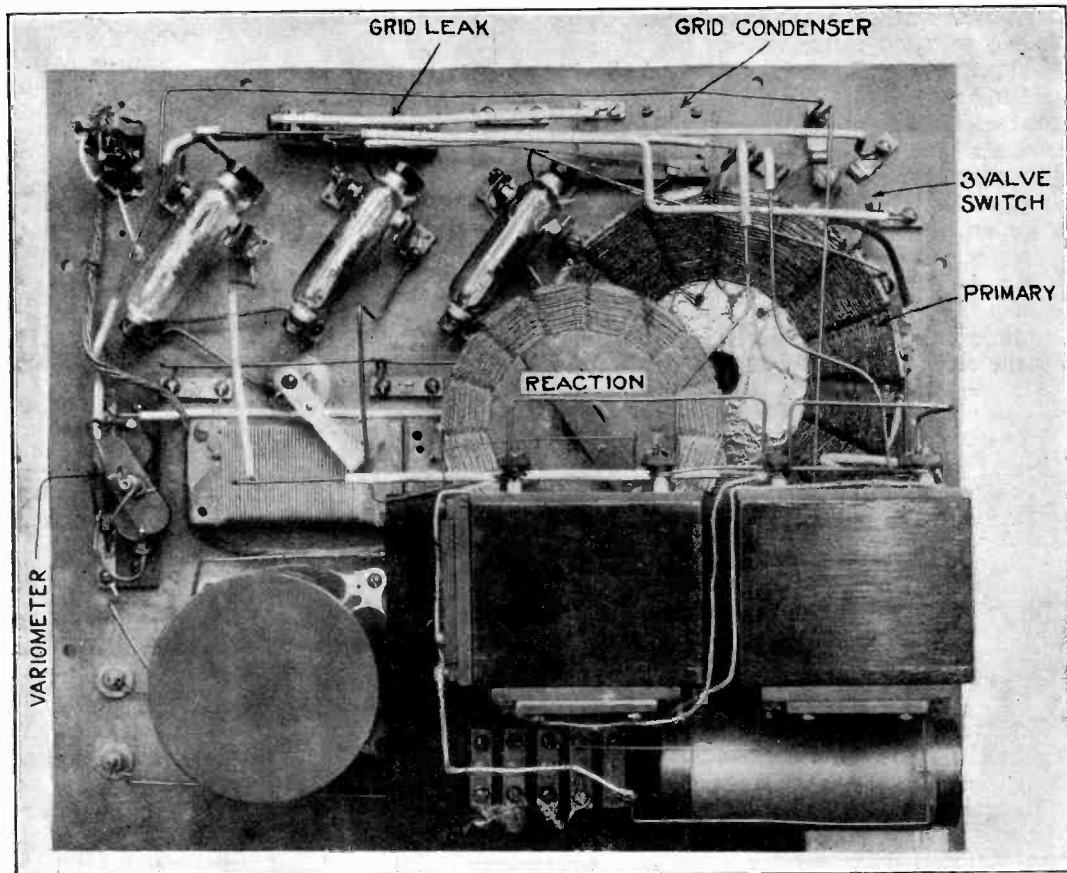

View of interior showing disposition of components.

of very weak telephony, as great distortion is very often produced when too much help is required from reaction, but if this assistance be not abused, the amount of undistorted amplification with one valve is remarkable. It is sometimes convenient to take comparatively little advantage of the regenerative amplification, but to switch in a second valve; this is specially noticed in the case of indifferent modulation at the transmission end.

and then go ahead again. This is a disadvantage, and means loss of time—valuable in the case of following conversations. The cylinder and ball also has its defects; it seems to be difficult to obtain oscillation when on the first stud, *i.e.*, for very short waves, the coupling between the primary and the reaction cannot be made tight enough.

The spider web possesses neither of these disadvantages; the reaction hiss is picked up

exactly where left, and very tight coupling can be obtained for the shorter waves. In the particular instrument I am describing, a reduction gear of 5 to 1 has been provided (an idea of a friend of mine), the lateral displacement of the reaction coil being therefore very gradual. These coils can however be worked quite well using a direct moving arm, the gearing being a refinement, convenient

job, and is also theoretically of less H.F. resistance than single wire. The first consideration seems to me to be of greater importance, for before one can construct a receiving instrument of such a perfect nature that the electrical qualities of the two wires can be appreciated, one has to be of a higher order than "an amateur instrument maker."

I have introduced a variometer fine tuning

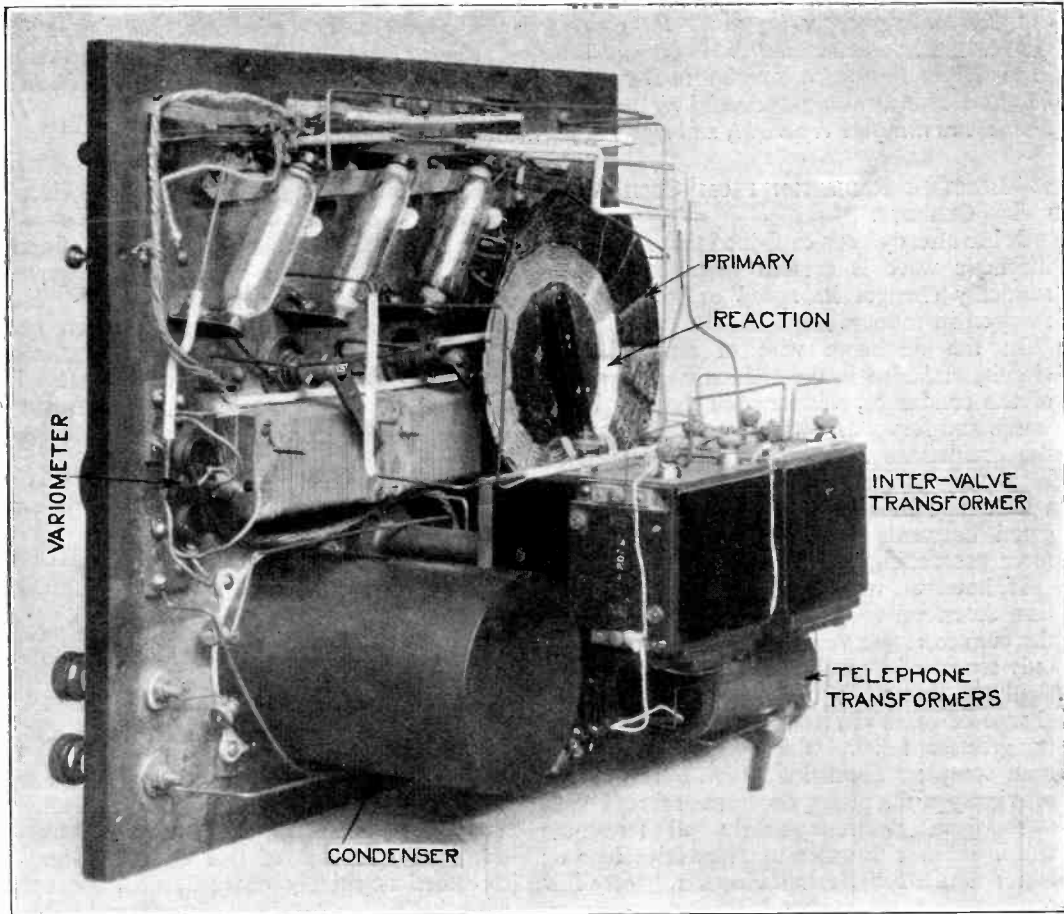

Another view of the arrangement of the parts.

but not absolutely necessary. I have found that for short wave working, using these coils to open like a book, as pancake coils are used for long waves, is not satisfactory, fine adjustment being more difficult; with lateral movement a greater latitude is obtained. For winding these coils I have found No. 30 D.S.C. quite satisfactory. The best wire is of course Litzendraht; it is superior from a mechanical point of view, makes a very neat

device in the primary, which is of great assistance in picking up weak telephony.

The valves used are of the "V 24" type, the detector having a 4-megohm leak with a condenser of about 0.0002 microfarads made to fit the leak by trial.

The telephone transformer is home-made with open core, and as will be noticed from the diagram, has two sections on the low tension side.

Electrons, Electric Waves and Wireless Telephony—XI.

By Dr. J. A. FLEMING, F.R.S.

The articles appearing under the above title are a reproduction with some additions of the Christmas Lectures on Electric Waves and Wireless Telephony given by Dr. J. A. Fleming, F.R.S., at the Royal Institution, London, in December and January, 1921-1922. The Wireless Press, Ltd., has been able to secure the serial rights of publication, and any subsequent re-publication. The articles are therefore copyright, and rights of publication and reproduction are strictly reserved.

2.—ELECTRIC RADIATION FROM OSCILLATORY CIRCUITS.

It has already been explained that an electromagnetic wave is created when an electron suddenly changes its speed or is started or stopped in motion.

In the discharge wire of an oscillatory circuit, and also in the dielectric or insulator of the condenser, electrons are dancing backwards and forwards with great rapidity, whilst the oscillations are taking place. Hence an oscillatory current must create electric waves which may be regarded as vibrations propagated outwards along the lines of electric force proceeding from electrons.

If, however, we consider the kind of circuit just described in which the metal plates of the condenser are very near to each other and only separated by a thin sheet of dielectric, we shall see that when one plate has its largest charge of extra electrons and the other plate its greatest deficit, which happens twice at each complete oscillation, then, owing to the proximity of the plates, the lines of force which start from electrons nearly all terminate within a short distance upon positive ions or atoms which have lost an electron. Very few of these electro-lines stretch far out into space. Hence, when vibrations are started along these electro-lines by the sudden movements of the electrons, very few of these vibrations are propagated entirely away from the condenser. In other words, the arrangement radiates badly because it does not get rid of much of the stored energy in the form of electric vibrations or waves propagated along electro-lines, which extend far into external space.

The oscillatory circuit above described is sometimes called a closed or nearly closed

oscillatory circuit and it is a poor electric radiator.

In 1887, H. Hertz invented a type of oscillator which has very great radiative power. Instead of placing the condenser plates near together he placed them as far apart as possible by attaching them to the outer ends of two metal rods placed in line with each other, their inner ends being provided with spark balls in proximity to each other (see Fig. 51).

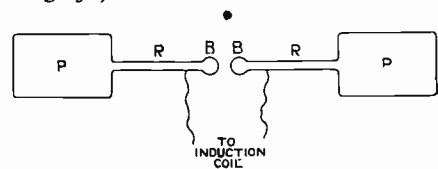

Fig. 51. A Hertz Oscillator or Radiator.

PP Metal Plates.
RR Metal rods.
BB Spark balls.

When these rods are connected to the terminals of an induction coil or electrical machine in operation, the plates are charged; one has an excess of free electrons, and is therefore negatively charged, and the other has a deficit, and is positively charged. When the electric pressure reaches a value determined by the length of the air gap between the balls, the conductivity of the air breaks down, it is ionized, a spark passes and electric oscillations take place, that is, free electrons vibrate backwards and forwards in the wire or rods.

If we consider the distribution of the lines of electric force (electro-lines) proceeding from the electrons in the negatively charged side of the oscillator rods before the spark discharge takes place, it will be seen that a

large proportion of these lines must stretch far out into space on all sides of the oscillator rods starting from the rods in a direction nearly at right angles to them (see Fig. 52).

When the spark discharge takes place the electrons crowded together in the supercharged (negative) rod begin to move suddenly towards the other deficiently charged rod so as to equalise the electron distribution or pressure.

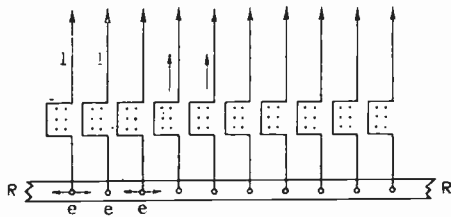

Fig. 52. Vibrations being propagated along electro-lines (l) proceeding from electrons (e) in oscillation.

This sudden motion of the electrons produces a "kink" or bend or loop on the electro-lines on account of the inertia of the latter as already explained in a previous section. The kinks on all the similarly directed electro-lines run together into a transverse loop of electric force (see Fig. 52) which flies outwards in the direction of the electro-lines.

The lateral motion of a line of electric force produces a magnetic force which is at right angles to the direction of the line of electric force and to that of its motion. Hence the moving loop of electric force is accompanied by moving loops or lines of magnetic force; the end on view of these last named lines are represented by the dots in the diagram in Fig. 52.

This combination of lines of electric force and lines of magnetic force at right angles, both sets moving at right angles or perpendicularly to their own direction is called an *electric wave*.

This wave moves with a velocity of 300,000 kilometres per second in empty space or in air, which is the same as the velocity of light. Otherwise stated, its velocity is 1,000 million feet per second.

Twenty-two years before Hertz began his experiments, Maxwell, in 1865, had theoretically arrived at the conclusion that electric and magnetic forces were propagated through space, not instantly, but with the velocity

of light, and had predicted the possible existence of electromagnetic waves, and given reasons for the opinion that visible light and therefore also radiant heat consist of electromagnetic waves of very short wavelength.

Maxwell had not, however, described any mode in which these long electromagnetic waves could be created or detected. The late Professor G. F. Fitzgerald suggested that Maxwell's electromagnetic waves might be created by the oscillatory discharge of a Leyden jar. He had also theoretically investigated the production of electromagnetic radiation by a high frequency alternating electric current in a closed loop of wire.

The late Professor D. E. Hughes had undoubtedly succeeded experimentally in generating Maxwell's electric waves, and what was more important he had empirically discovered a way of detecting them without clearly understanding what he was doing. Hughes' original apparatus is now exhibited in the Science and Art Museum at South Kensington, London.

Hertz invented a simple but not very sensitive method of detecting these Maxwell waves by using a circle of stiff wire, which was interrupted in one place by a small pair of spark balls (see Fig. 53), forming the earliest type of what is now called a *frame aerial*.

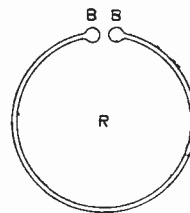

Fig. 53. A Hertz resonator ring.

Hertz used this "resonator" as he called it in the following manner. He placed at one station his open circuit oscillator (see Fig. 51) with its rods in a horizontal position. When this oscillator was in action it sent out electromagnetic waves in which the electric force was in a horizontal direction and on the axial line nearly parallel to the oscillator rods. Also the motion of these created magnetic force disposed in a vertical direction and in the same plane as the electric force. The resonator ring was then placed at a certain distance away from the oscillator with its

plane vertical and its spark gap turned so that the line joining the resonator spark balls was parallel to the line joining the spark balls of the oscillator (see Fig. 54).

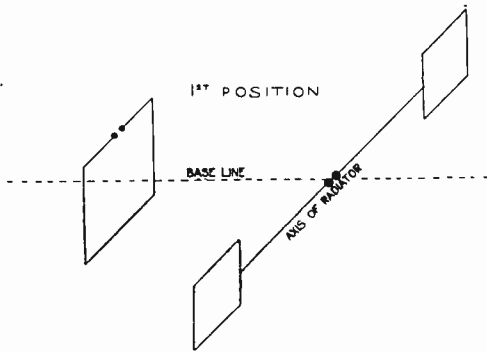
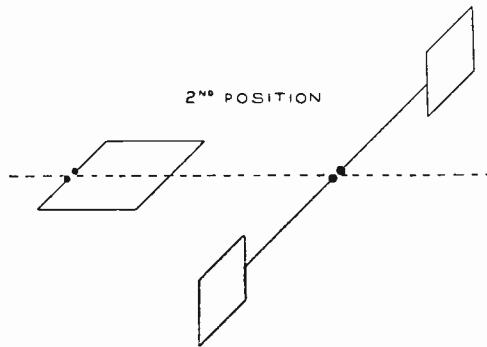
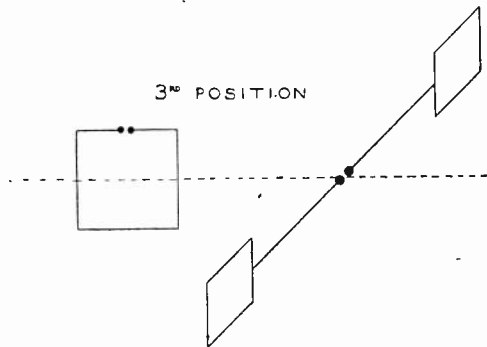

Fig. 54. (a) Sparks are seen at resonator balls when the oscillator is in action.



(b) No sparks seen at resonator balls when oscillator is in operation.



(c) No sparks seen at resonator balls when oscillator is in operation

Under these conditions small sparks are seen at the receiver balls. These are due to the fact that the lines of magnetic force of the electric wave sent out by the oscillator cut through the two sides of the resonator, but do not cut them simultaneously. The result is to produce in the circuit of the ring two opposite but unequal electromotive forces which create a current in the ring, and hence a spark at the resonator balls.

This effect needs a little further explanation, and we must therefore explain on the electron hypothesis the nature of the physical operations which produce the induction, as it is called, of electric currents.

Faraday's greatest experimental achievement was his discovery in the autumn days of 1831 that a magnet moved near to a conducting circuit in such manner that the lines of magnetic force proceeding from the poles of the magnet "cut across" the wire circuit.

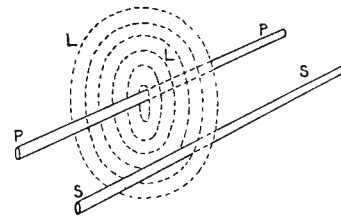

Fig. 55. A diagram showing the manner in which expanding lines of magnetic force round a primary circuit PP cut a secondary circuit SS

It is necessary to interpret this effect in terms of the electron theory. Consider two straight copper wires stretched parallel to each other (see Fig. 55). We have seen that an electric current consists in a procession of free electrons in the wire, which though agitated by an irregular motion, yet all struggle forwards in one direction. We have also pointed out that when an electron moves it creates circular lines of magnetic force which lie in planes perpendicular to its line of motion. Again it has been mentioned that these lines of force do not spring into existence suddenly at all distances from the electron but are gradually propagated outwards with the velocity of light just as the circular ripples produced on a pond by casting into it a stone, gradually expand outwards in circles of ever-increasing size (see Fig. 55).

Consider then the case when we start a direct current in a wire PP. The electrons in one of the wires then begin to drift forward.

The circular lines of magnetic force *LL*, which are thereby generated, grow out from the primary wire *PP*, enlarging gradually in size. These lines therefore in time "cut across" the other parallel wire *SS*.

In a previous section it has been pointed out that when a line of magnetic force moves parallel to itself it creates an electric force which is in a direction at right angles to the line of magnetic force and to the direction of motion of the latter.

We can memorise the relative directions by holding the forefinger, the thumb and the middle finger of the right-hand in directions mutually at right angles (see Fig. 56). Let the direction in which the forefinger points be the direction of the line of magnetic force, that means the direction in which the pole of a magnet which points to the earth's North Pole would be moved along it.

Since the secondary wire contains free electrons, the result is that as the lines of magnetic force generated by the motion of the electrons in the primary wire "cut across" the secondary wire, a momentary electric force will be created in it, which will move the free electrons in the secondary wire in the *opposite* direction to the movement of those in the primary wire. This is called an induced secondary current at "make." It only lasts for a short time, namely, whilst the circular expanding lines of magnetic force are taking up their permanent positions in space.

Suppose then that the current in the primary wire is stopped or that the drifting electrons in it are brought to rest. This implies that the magnetic field round the wire vanishes. It does not, however, vanish at all distances at the same instant, but the

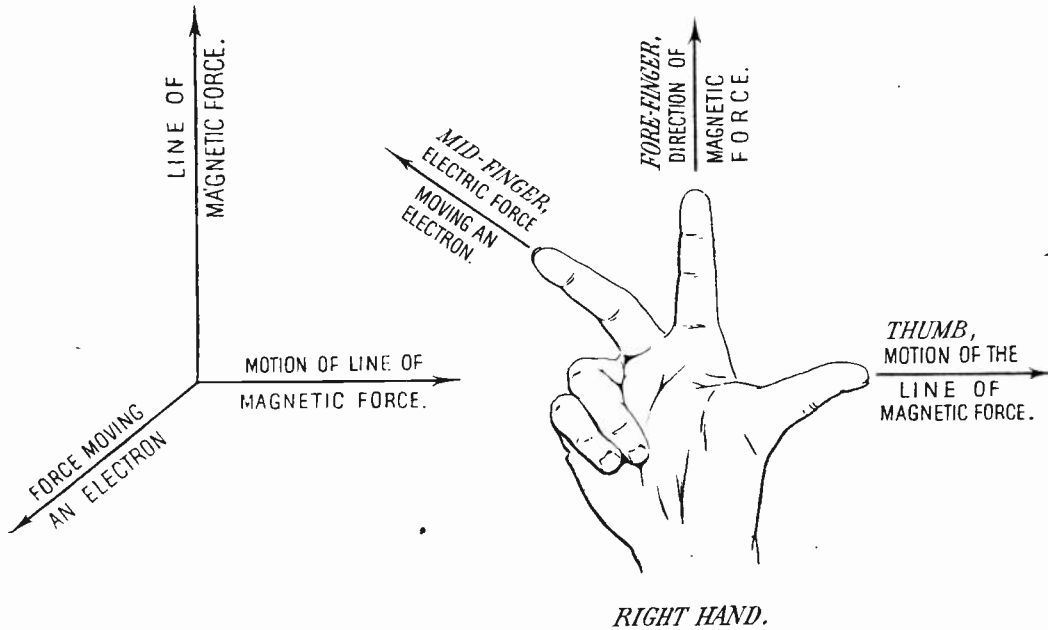

Fig. 56. The Fleming Right Hand Rule, connecting electric force, direction of flow of current and direction of motion lines of magnetic force.

Let the direction of the thumb represent the direction in which the aforesaid line of magnetic force is moving transversely to its own direction. Then the direction in which the middle finger points will be the direction in which a negative electron, in a conductor, across which this line of magnetic force moves, will be urged by the electric force created by the motion of the line of magnetic force.

circular embracing lines of magnetic force are, so to speak, sucked back into the wire. In so doing it will be evident that some of them again "cut across" the secondary circuit, but in an opposite direction to that in their outward course.

It will be clear then from the above explanations that the result of this contraction is to create a momentary electric force which drives

the free electrons in the secondary wire in the *same* direction as that of the drift motion of the electrons in the primary wire. This is called the induced current at "break" of primary current.

It will be seen then that if the primary circuit is traversed by an alternating electric current, that is if the free electrons in the primary wire surge backwards and forwards like the ebb and flow of the tide in the mouth of a tidal river, the result will be to produce a similar alternating current in the secondary wire or surging motion of its free electrons which keeps in step with the primary current, but is always in an opposite direction as regards flow.

It is not necessary that the two wires should be straight; they may be both coiled in spiral fashion round a rod or tube of wood or insulating material, only then each wire must be covered with silk, cotton or enamel, to insulate the turns from each other (see Fig. 57).

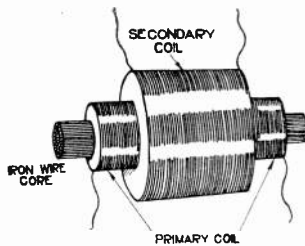

Fig. 57. An induction Coil consisting of two insulated wires wound round a bundle of fine iron wires as a core.

An arrangement of this kind is called an *Induction Coil* or *Transformer*.

When the alternating current is a low frequency current, viz., about 50 to 200 or so reversals of current per second, we can increase the effect by inserting in the tube on which the wires are coiled a bundle of fine iron wires called an iron core. In the case of high frequency current no iron core of the above kind is of advantage.

The induction of electric currents by moving magnets proceeds from similar causes. A permanent magnet, whether bar or horse-shoe, carries about with it a field of magnetic force, the direction of the lines of which may be rendered evident in the well known manner by sprinkling iron filings upon a sheet of paper laid over the magnet (see Fig. 58).

If then the magnet is moved in any manner so that its lines of force "cut across" a con-

ducting wire, the free electrons in the latter are urged in one direction along the wire for the same reasons as explained in the case of the expanding magnetic field of a primary wire.

This fact is the starting point for the construction of all forms of dynamo electric machines in which a current is generated by moving a coil of wire in a magnetic field of force.

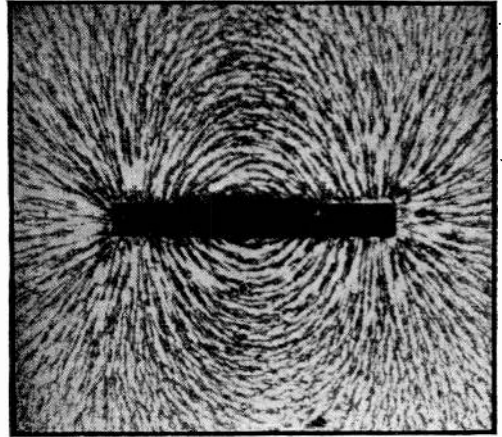

Fig. 58. Lines of Magnetic Force round a Bar Magnet delineated by sprinkling iron filings on a sheet of paper laid over the magnet.

The ordinary spark induction coil, so much used in Roentgen or X-ray work, consists of a bundle of fine iron wires which is wound over with a number of coils of cotton-covered copper wire through which passes the current from a battery which is rapidly interrupted or started and stopped by means of an appliance called a "break." Over this primary coil is wound in sections an immense length of very fine silk-covered copper wire called the secondary coil. When the primary coil is traversed by the primary current the lines of magnetic force due to it are linked with the secondary circuit or pass through it. When the primary current is suddenly stopped these lines contract or shrink up again into the primary circuit. In so doing they "cut through" the secondary circuit and create in it a very high electromotive force, urging the free electrons in the secondary circuit violently in one direction. So much so that they burst forth at one end of the secondary circuit and create a spark discharge.

The electric force or force moving the free electrons in the conducting wire is proportional to the product of the magnetic force (H) of the moving lines of magnetic force and to the velocity v of these lines resolved perpendicularly to the wire.

If the wire has a length l centimetres then the electromotive force produced by these lines cutting or crossing the wire is proportional to the triple product Hvl .

It does not matter whether the copper wire moves transversely to the field at rest, or whether the lines of magnetic force themselves move, as in the case of an electric wave, so as to cut across a stationary conducting wire. In both cases we have an induced electromotive force created.

We can now return to the consideration of the Hertz oscillator and its corresponding receiving circuit.

It has been explained that when the free electrons in the oscillator rods dance backwards and forwards with great rapidity, the result is to propagate outwards along the electro-lines proceeding from the free electrons in them, "kinks" or vibrations which may be conceived to travel along the electro-lines just as a "kink" or wave travels along a stretched cord fixed at one end when a sudden jerk is given at the other end.

The "kinks" produced simultaneously on a number of electro-lines which are in the same direction run together into a travelling loop of electric force which moves with the speed of light in the direction of the electro-lines and is accompanied by lines of magnetic force the directions of which are perpendicular to the electro-lines and to the direction of motion of the latter (see Fig. 52).

Suppose next we set up at any distant place another oscillator exactly like the transmitting oscillator comprising two plates at the outer extremities of two rods placed in line and with a gap in the middle which can be bridged over by some form of conductor. Let this receiving circuit, as it is called, have its rods placed parallel to the rods of the transmitting oscillator. Being of the same form as the transmitter, this receiving circuit has the same natural time period of oscillation. In other words, it is "in tune" with the transmitter.

Hence, as the lines of magnetic force in the electric wave passing over it cut across the rods they will create in them an alternating electromotive force. If the receiving circuit is not in tune with the transmitter, the latter

would produce very little effect in creating a current in the former. If, however, it is in tune, the repeated action of the incident waves will soon create an alternating current in the receiver.

The action is closely analogous to the effect of jumping upon a springy plank supported at the two ends like a bridge. The plank has mass and elastic resistance to bending. If a boy stands in the middle of the plank his weight causes it to bend slightly. The plank has, however, a natural time of oscillation. If the boy jumps up and down, but not in time with the natural period of oscillation of the plank, he will not produce much effect in increasing the deflection. If, however, he times his jumps so as to agree with the natural time period of flexural vibration of the plank, he will soon find that the bending of the plank at each jump becomes so large that it will probably be in danger of breaking. It is for this reason that a regiment of soldiers are generally ordered to "break step" on crossing a suspension bridge, because if it should so happen that the time period of their marching feet should agree with the natural period of flexural oscillation of the bridge, the safety of the structure might be endangered.

For the same reason we can set in strong oscillation a pendulum consisting of a massive bob suspended by a string by means of little puffs of air or feeble blows with a feather, provided we administer these impulses at intervals of time exactly equal to the natural time period of oscillation of the pendulum. This fact in its widest form covers the principle of the *resonance* of two vibrating bodies, and is of very great importance in connection with wireless telegraphy and telephony.

We have seen that when two circuits are adjacent to each other an alternating current in one circuit will induce an alternating current in the other circuit. Suppose these two circuits each consist of a condenser of a certain capacity C in series with a wire having a certain inductance L . The natural time period of the circuit is then, as we have shown, proportional to the square root of the product of the capacity of the condenser and the inductance of the wire or to \sqrt{CL} .

This last is called the *oscillation constant* of the circuit.

If then the two circuits have equal oscillation constants, even though in one the capacity is large and the inductance small, whereas in the other the reverse is the case, these cir-

cuits will be in tune with each other, and if placed in proximity free oscillations created in one circuit will induce strong oscillations of equal frequency in the other circuit. It should be noted, however, that when a pendulum or other system capable of vibration receives a single blow or impulse it will, if then left to itself, vibrate in its own natural time period. So in the case of an electric oscillatory circuit, a single strong electromotive impulse due to an electric wave falling upon a properly-tuned receiving circuit will set it in prolonged oscillation provided that this receiving circuit is not too good a radiator.

(To be continued.)

Thus in the case of Hertz's original experiments, he used the transmitting rod oscillator above described, and a nearly closed receiving circuit made of a circle of wire with a small spark gap in it.

This rod oscillator is a very good radiator, and sends out all its accumulated electric energy in one or two vibrations at most.

On the other hand the closed receiving circuit is a very poor radiator, yet when struck by the electric waves from the transmitter it is set in prolonged oscillation, and there may even be 500 oscillations of current in it before they completely die away.

High Frequency Telephony over Power Transmission Lines.

Experiments recently conducted in Japan have resulted in the replacement of the existing telephone lines used for intercommunication between the power and substations of the Ujigawa Electric Company

the lines, two horizontal antennæ, about 400 metres long, are disposed some two or three metres beneath the wires of the transmission line, one for transmission and one for reception.

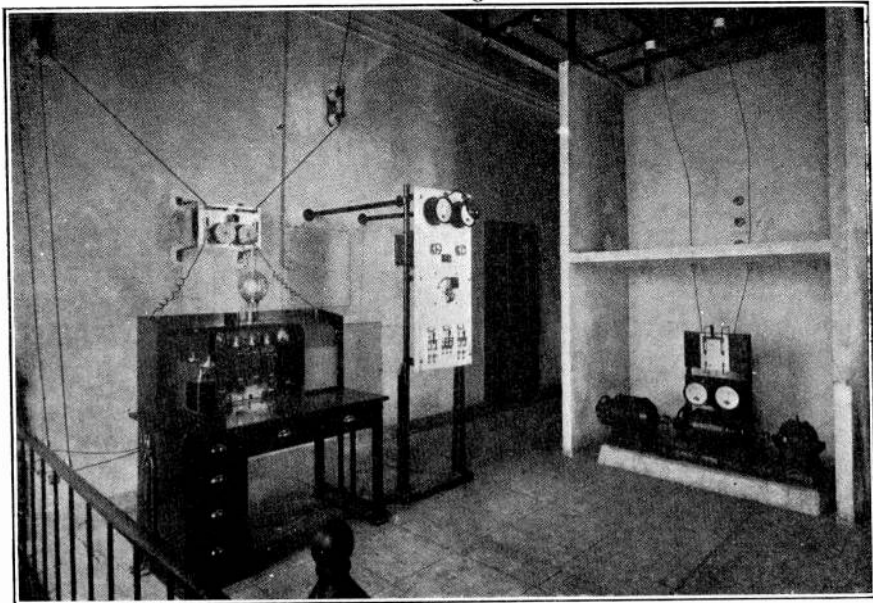

Cabinet Telephony Set as installed at a sub-station.

by a system of high frequency telephony, using the power transmission lines themselves as conductors and successful continuous operation is maintained over a distance of some 34 kilometres.

The power transmission lines have a pressure of 55,000 volts, 3 phase, and at points where it is desired to connect a telephone set to

Apparatus as depicted in the illustration is used on wavelengths of 1,700 and 1,000 metres to allow two conversations to be carried on from different points at the same time.

Excellent results have attended the operation of these installations, the disturbing factor *noise* as experienced with the original line installations being entirely eliminated. E. A. G.

The Radio Society of Great Britain.

PROCEEDINGS OF ORDINARY GENERAL MEETING, NOV. 22nd, 1922.

(Concluded from page 350.)

The President.

It has been proposed and seconded that this Society be now termed the Radio Society of Great Britain, that Associates be added to the membership, and that the amendments to the rules which have been circulated should be adopted for the present—they may require alteration later on—but until we do make the alterations, that these rules be adopted by the Society.

That concludes the special meeting. We will now come to the ordinary business of the meeting.

There is a letter from the Postmaster-General, which reads as follows:—

General Post Office.

London, E.C.1.

9th November, 1922.

Sir,—The Postmaster-General's attention has been drawn to the large and increasing number of transmissions, chiefly of music, from private experimental stations which are apparently not for purposes of bona-fide experiments, but for purposes of advertisement and entertainment. Such transmissions are contrary to the understanding on which the permits are granted, and not infrequently cause interference with genuine experimental work.

As the result of representations from the Wireless Society of London on behalf of Wireless Experimenters generally, the conditions of the grant of transmitting permits were relaxed. The great majority of the holders of experimental transmitting permits are members of the Wireless Society of London or of an affiliated Society, and the Postmaster-General would be glad if your Society would consider what steps they can take to make clear to the holders of such permits the necessity in the general interest of strict adherence to the conditions of their permits.

Failure to observe such conditions may not only involve the withdrawal of the particular permits, but will inevitably lead to a demand for the imposition of more stringent conditions generally.

(Signed) F. J. BROWN.
(For the Secretary.)

The Secretary,

Wireless Society of London.

We had anticipated that letter, and a meeting of transmitting licence holders had been held and certain resolutions passed which have been amplified by a sub-committee appointed at that meeting. The proposals of the sub-committee will be presented to the transmitting members at another meeting to be called shortly.

Another point I should like to make known is that the arrangements for the Transatlantic Tests are well in hand, and the London Electricity Supply Company have kindly allowed the Society

the use of a 200 ft. chimney for an aerial. Operators who are willing to assist in the transmissions, and who do not mind sitting up between the long hours of midnight and 6 a.m., should give their names to the Hon. Secretary, or to Mr. Coursey. I hope those who are able will lend their assistance. I will ask Mr. Coursey to say a few words on the matter.

Mr. Coursey.

The sub-committee of the Society which has been handling the arrangements in this country for the forthcoming Transatlantic Amateur Communication Tests which are being organised by the American Radio Relay League, has met on several occasions. These tests are divided up into two sections—in the first the American and Canadian amateurs will transmit, and during the second European amateurs in France and Great Britain will try and signal back to the United States.

With regard to the latter part of the tests, as has already been announced, the sub-committee has had in hand some preliminary arrangements for the erection and operation of a special station in the neighbourhood of London, on behalf of the Wireless Society of London, but these preliminary arrangements have not been able to be completed as various unforeseen circumstances have arisen.

As these preliminary arrangements were not completely carried through, other arrangements are now well in hand for the operation of another special station.

(The arrangements for the tests as they exist to-day were then briefly outlined on the lines already published in these columns. See pages 276-277, November 25th issue).

There is only one other thing which I wish to mention in connection with these tests at the present moment, and that is to ask anyone who is not proposing to listen in to the tests to keep their receivers and transmitters quiet, in order that those who are listening in may have the best possible chance to hear the signals from the American stations, and also to make the request that those who are listening in do not radiate any energy from their aerials, but to employ a separate heterodyne for the C.W. signals, because not only in the first tests, but in last year's ones as well, many listeners here were badly jammed from that source. I would like to emphasise this point as much as possible, so that everyone possessing radio sets may try and keep them as quiet as possible during the test periods.

The President.

I think all members on both sides of the Atlantic who are taking part in these tests will be very thankful and grateful to Mr. Coursey and the Committee for the great amount of work they have put in in completing this organisation, and I

sincerely hope that those who are listeners, and those who are not taking part in the tests will answer his appeal and not interfere with the others.

Mr. O. J. Carpenter is here to speak on behalf of St. Dunstan's, and to explain in what way our members may be able to assist those who were blinded in the war and now desire to interest themselves in wireless.

Mr. O. J. Carpenter.

I have been asked by Captain Ian Fraser, the blind Chairman of St. Dunstan's, who is at present visiting Germany, to make some remarks on his behalf regarding a scheme which has, I believe, the approval of our Committee.

Some time ago our President, Admiral Sir Henry Jackson, visited St. Dunstan's and had a long conversation with Captain Fraser, who is, by the way, one of the ablest amateur radio workers I have met. It was mentioned that a number of the St. Dunstan's men settled in various parts of the country were extremely interested in radio, and it was the suggestion of our President that this interest might be stimulated if these men were brought into touch with wireless societies in their particular districts. The Patron of our Society, H.R.H. The Prince of Wales, exhibited great interest in this proposal, and desired that it might be put into effect at the earliest moment.

Until the War, and the advent of St. Dunstan's, we looked upon a blinded individual as a poor, helpless being stricken by perhaps the hardest blow of Fate. You will note that I said "until the advent of St. Dunstan's," for the late Sir Arthur Pearson and his lieutenants changed this picture, and a visitor to St. Dunstan's, hearing the happy laughter of the men, noting the quiet contentment on their faces, and seeing the fruits of their industry, can agree with the spirit that would see "Nothing is here for tears" written across the portals. But I will not linger upon the work of this wonderful Institution—we all know what the splendid men and women controlling its destiny have done for our sightless soldiers and sailors.

Radio was introduced to St. Dunstan's by Captain Fraser some two and a half years ago. He visualised the time when broadcasting would come, and the gradually extending use of radiotelephony convinced him that one day it might link the blinded man with the happenings of the world. He has had to wait until to-day for the realisation of his dream.

A blinded man's hobbies are, of course, limited, but radio reception is one to which he can devote himself on something like equality with his fellow men. But he has to overcome certain initial difficulties; for instance, it is not possible for him to lay out and install his own aerial and earth system, and it is difficult for him to visualise the manipulation and functioning of apparatus he has never seen. It is not easy for him to acquire that preliminary grounding in the subject which is, to us, rendered fairly simple by means of diagrams and illustrated text.

It is here that members of the Wireless Society of London and its affiliated societies can render help by writing to the Headquarters of St. Dunstan's Work, Inner Circle, Regents Park, N.W., and offering to act as mentors to any blinded would-be radio enthusiasts in their districts.

One or two societies have already done this,

and have, indeed, made the men honorary members of their circle.

Please remember that this is not a plea for monetary assistance, it is not a plea for charity; it is, in my opinion, a splendid opportunity to give of our knowledge to the Tommies and Jacks who gave their eyes for us.

The President.

I know the members of this Society are in full sympathy with this object, and I hope that the spirit will spread to our affiliated Societies in the provinces and round London, and that they will do their best to help. I have seen the men at St. Dunstan's, and have been struck with the happy spirit that pervades the men and all associated with them. I am sure that they have our sympathy, and will get practical knowledge and assistance from those who are connected with our Society.

I have the pleasure to announce that Sir Henry Norman, the Member for Blackburn, will take over the Presidency of this institution next January, and I think the Society and all of us are to be very much congratulated that he is willing to do so.

The next meeting, in December, is the Annual Meeting for the election of the officers and the Committee, consequently there are no vacancies. The same names will come forward next year, with the exception of myself, as before mentioned; but if any of the members of the Society wish to put anybody on the Committee, they are invited to send in names fourteen days before the next meeting.

I am sorry we have taken so much time away from our lecturers in this business meeting, but I will now ask Mr. Blake to read his paper on the "Mechanical Model Illustrating the Action of the Three-Electrode Valve,"* and also Mr. Maurice Child to give his paper on "A Five-Valve Selective Amplifier."†

These papers were then read, and in the absence of discussion, the President, after proposing a vote of thanks to the lecturers, announced that all the new members had been elected and societies accepted for affiliation,‡ and that the next meeting would be a meeting of the Radio Society of Great Britain, taking place before Christmas on Wednesday, December 20th.

Mr. E. H. Shaughnessy.

Mr. Chairman, before we go I should like to draw attention to the fact that we started the evening by changing the name of this Society to the Radio Society of Great Britain, and nearly every speaker since has been talking about wireless. There is one other thing, by the way, and that is that the official organ of the Society is *The Wireless World*. Could we persuade them to change their title? They have got half way there as *The Wireless World and Radio Review*—if they must have Wireless. Why not style the journal "The Radio Review and Wireless World."

The meeting adjourned at 7.45 p.m.

A New Company.

Wireless Service, Ltd., is a new company which has opened offices and showrooms at 2, Lower John Street, Piccadilly Circus, W.1. The products of leading manufacturers may be obtained from this establishment.

* See pp. 311-314, Dec. 2nd, 1922.

† See pp. 343-345, Dec. 9th, 1922.

‡ For list see p. 309, Dec. 2nd, 1922.

Wireless Club Reports

NOTE.—Under this heading the Editor will be pleased to give publication to reports of the meetings of *Wireless Clubs and Societies*. Such reports should be submitted without covering letter and worded as concisely as possible, the Editor reserving the right to edit and curtail the reports if necessary. The Editor will be pleased to consider for publication papers read before Societies. An Asterisk denotes affiliation with the Radio Society of Great Britain.

Correspondence with Clubs should be addressed to the Secretaries direct in every case unless otherwise stated.

Newcastle and District Amateur Wireless Association.*

Hon. Secretary, Mr. Colin Bain, 51, Grainger Street, Newcastle-on-Tyne.

The following lectures have been given during the month of November:—"Theory of the Thermionic Valve," by Mr. Bain; "Short Wave Reception," by Mr. W. G. Dixon; "The Chemistry of the Secondary Cell," by Mr. Urquhart; "Balancing 'out' Tuning Devices," by Mr. Bain; "The Singing Arc," with demonstrations, by Dr. Thornton. The last lecture in the list was given in the lecture theatre of the Armstrong College. Members and friends of the local Societies were also present. The subject of the lecture, "The Singing Arc," proved to be a very much more interesting affair than many present had expected. After a short explanation of the principles involved, Dr. Thornton and his assistants demonstrated the astonishing properties of the arc as a producer of both simple and complicated sounds. A microphone was fitted in an adjoining room, and after the more elementary demonstrations were over, the arc was made to act as a loud speaker, reproducing loud speech and music (supplied by voice and a gramophone) all over the hall. The lecturer also used two arcs in series to increase the volume of the sounds. The audience were very much impressed by the weird effects shown, and a hearty vote of thanks was passed to the lecturer for a very instructive evening.

Tottenham Wireless Society.*

Hon. Secretary, Mr. R. A. Barker, 22, Broadwater Road, Bruce Grove, N.17.

At Bruce Grove Schools, Sperling Road, on November 22nd, a very interesting lecture on "Aerials" was given by Mr. Hall. A hearty vote of thanks was given to the lecturer for such an interesting evening.

A two-valve set was presented to the Society by Mr. Kaine-Fish, for which he was accorded a hearty vote of thanks. Business was discussed and several new members enrolled.

The Society is now forty-five strong, and has an interesting programme of lectures before it.

Ilkley and District Wireless Society.*

On November 20th, Mr. D. E. Pettigrew, Hon. Secretary of the Leeds and District Amateur Wireless Society, gave a lecture on "Maritime Radio Communication." He traced the development of wireless as applied to ship practice from the earliest experiments of Marconi. The utility of wireless as a means of communication between ships and from ship to shore was explained, and also the method of handling messages.

A hearty vote of thanks proposed by the Chairman, Dr. J. B. Whitfield, was unanimously accorded the lecturer.

Radio Society of Highgate.*

Hon. Secretary, Mr. J. F. Stanley, 49, Cholmeley Park, Highgate, N.6.

An interesting lecture was given on November 10th, by Mr. F. L. Hogg, on "The Armstrong Super-Regenerative Circuit." The theory of this circuit was carefully explained, and several diagrams were drawn on the board.

On November 17th Mr. H. Andrews, B.Sc., gave a description of his transmitting station (2.TA). The set was exhibited.

On November 24th, Mr. G. W. Sutton, B.Sc., gave the first of his lectures on "High Frequency Amplifiers." The advantages and disadvantages of resistance, reactance, tuned plate and transformer coupled amplifiers were discussed.

Mr. Sutton gave his second lecture on this subject on December 1st, when he began by describing the Lokap coil winder, and giving hints as to how to get the best results with the machine.

The Radio Dance organised by this Society and held at the Gate House Hotel, Highgate, on November 25th, was a phenomenal success, a large number of people from all parts of London being present. During the intervals between the dances the loud speaker was switched on, and thus the function was a combined dance and concert. During the evening several dances were danced to the orchestral selections from the London broadcasting station, and these items proved exceedingly popular. An indoor aerial and four valves were used.

The Corinium Wireless Society.*

Hon. Secretary, Rev. B. R. Keir Moilliet, The Old Vicarage, Cirencester.

The Society arranged a public lecture by Mr. Lawrence Johnson of Sheffield on November 11th. There was a good attendance, and the lecture was closely followed. The history of the development of Wireless Telegraphy was traced from the Hertz oscillator down to modern C.W. and Telephony. The lecture was illustrated by excellent lantern slides, and at 9 p.m. 2 LO kindly transmitted a special programme of music, the singing of Mr. Kenneth Ellis being particularly appreciated. Several new members have since joined the Society. After paying expenses, the balance of the proceeds is being sent to St. Dunstan's.

Stoke-on-Trent Wireless and Experimental Society.*

Hon. Secretary, Mr. F. T. Jones, 360, Cobridge Road, Hanley.

On November 23rd, Mr. Bew demonstrated with his Burndept Set. Concerts were received from the British Broadcasting Company at Manchester and Birmingham. A hearty vote of thanks was accorded to Mr. Bew.

Amateur wireless reception in the district has received a great impetus this last week or so, owing to the British broadcasting stations having commenced their nightly programmes.

Blackpool and Fylde and Lytham Saint Annes Wireless Societies.*

Hon. Secretary, Mr. C. Sheffield Doeg, 6, Seventh Avenue, South Shore, Blackpool.

Important developments in connection with the above Societies were foreshadowed at the Second Annual General Meeting, held at the Caf  Waldorf, Church Street, Blackpool, on November 23rd. Colonel P. Warren, C.M.G., C.B.E., the President, presided.

The membership in November, 1921, was 84, at present it is 112. During the year various apparatus has been purchased and a branch has been opened for Lytham Saint Annes members.

The Treasurer's report showed balance brought forward from the previous year £10 4s. 11d. Subscriptions, entrance fees, donations, and income from the sale of badges amounted to £47 1s. 6d. At the end of the year there was a credit balance of £2 0s. 5d., but there were outstanding accounts against this, which would leave an adverse balance of £1 7s. 5d. But during the year component parts of instruments had been purchased at a cost of £13 1s. 4d., and the complete instruments were worth £20.

Mr. H. D. Collinge, the Chairman of committees, said they were considering a move to better quarters. They had secured a fine spacious room in the basement of the Hippodrome buildings adjoining the Billiard Hall, The Blackpool Entertainments (1920), Ltd., having met them in a very fair manner.

Colonel P. Warren, C.M.G., C.B.E., Postmaster of Blackpool, was re-elected President unanimously.

Other officers elected were: Vice-Presidents, Dr. W. H. Buckley; Messrs. W. R. Challinor, C. F. Critchley, C.C., J.P., J. F. Fish, L. H. Franceys, A. T. Liver, A. Shorrocks and Dr. A. E. Iken, LL.D., B.Sc. (Director of Education to the Blackpool Corporation). Mr. C. Sheffield Doeg, Hon. General Secretary; Mr. L. R. Blackburn, Hon. Treasurer; Mr. A. R. Harrison, Hon. Organising Secretary (General Manager of the Hippodrome); Mr. H. Cross, Hon. Assistant Secretary; Mr. F. C. Hollingworth, Hon. Auditor; Mr. D. Worthington, Hon. Librarian; Mr. J. V. Potter, Hon. Engineer; Mr. J. F. Fish, Hon. Transmitter. Executive Committee in addition to above: Mr. and Mrs. H. D. Collinge, Messrs. W. A. Frost, and Miss M. Joule.

Mr. W. R. Burne of Sale was made a perpetual Hon. Vice-President.

In order to preserve the memory of the late Mr. H. H. Knowles, he was elected an Hon. Member deceased.

Fulham and Putney Radio Society.*

Hon. Secretary, Mr. J. Wright Dewhurst, 52, North End Road, West Kensington, London, W.14.

At headquarters on November 24th, the Secretary gave a report of his visit to the General Meeting of the Radio Society of Great Britain.

Ex-Gunner Bates, a blinded soldier and a member of St. Dunstan's, an honorary member under the scheme to assist St. Dunstan's men, attended the meeting and was made very welcome. Several of the members have already made offers of assistance.

A proposal by the Whale Wireless Co. offering a prize for the best constructed piece of wireless apparatus made by an amateur was read and it was proposed to accept their very generous offer.

Mr. B. G. Calver gave a very long and interesting lecture on "Accumulators and Secondary Cells."

Wallasey Wireless and Experimental Society.*

Hon. Secretary, 106, Albion Street, New Brighton.

A highly successful meeting was held on October 25th.

The Chairman lectured on "Unit Systems, their Theory and Construction." Mr. Mason dealt very fully with an excellent set of his own construction, in which he placed the main condenser on the tuning panel, the set being so arranged that the number of units are reduced to a minimum without interfering with the elasticity of combination which is the main feature of unit construction.

The lecture was undoubtedly of the greatest possible service both to the advanced workers and the enthusiastic beginners.

A hearty vote of thanks to Mr. Mason was recorded.

A general committee meeting was called to discuss some important business brought forward by a member.

It was decided to proceed with the construction of an amplifying unit without delay. Some members very kindly offered component parts of the unit as gifts to the Society.

Manchester Wireless Society.*

Hon. Secretary, Mr. Y. W. P. Evans, 2, Parkside Road, Princess Road, Manchester.

November 26th. After having dismantled the transmitting set used the previous week for the transatlantic test, and substituted A.C. for D.C. supply the work of installing the transformers and rectifying valves was commenced on Saturday afternoon at 2 p.m., and the first tests were made at 11.50 p.m., everything working well. At 1 a.m. the circuit was still being adjusted and tuned, but insufficient radiation was reached to justify a call to 1AW and 2FP, the two American stations with whom the Society were working. At 2 a.m. a maximum radiation of about 9 amperes was registered, and a fifteen minutes call was given and repeated at 3 a.m. Several American amateur stations were heard working, and a few remances were made to the transmissions which started the idea that they had been heard. A special survey was undertaken with the idea of getting the utmost output at the 4 a.m. transmission, and a few preliminary trials showed a little improvement and the call was commenced, but at two minutes past the hour the fuses were blown and after examination it was found that the transformer supplying one of the rectifying valves was shorting across the primary winding, which was all the more exasperating owing to the fact that one of the members had spent all Friday night winding this instrument. No spares being at hand, a desperate effort was made to overcome the difficulty by putting 5,000 volts A.C. direct on to the plates of the power valves. This method only gave a radiation of about three amps, but a call was made, and a list of stations received repeated. After listening in for another hour it was decided to abandon the tests until the following week. 36 stations were recorded, and these added to the 23 of the previous week and 22 on the 23rd, gave us a total of 81 stations for the week. Further tests are being made on December 17th, 24th and 31st, these having the approval of the P.M.G. Four or five American stations were recorded on a loud speaker.

Leeds and District Amateur Wireless Society.*

Hon. Secretary, Mr. D. E. Pettigrew, 37, Mexton Avenue, Chapelton Road, Leeds.

An instructional meeting was held at the Grammar School, Leeds, on November 17th, the first part of a paper entitled "Inductance and Capacity" being given by Mr. W. G. Marshall. The elements of self-inductance and the important effects of the E.M.F. of self-induction in A.C. sets of high and low frequency, were thoroughly examined. Mr. Marshall was heartily thanked.

A general meeting was held at the Grammar School on November 24th, the President (Mr. A. M. Bage) taking the chair at 8 p.m. Mr. C. F. Phillips lectured on and demonstrated "Burndept" apparatus. The subject of amateur transatlantic tests was also touched upon.

A discussion took place and a vote of thanks accorded to Mr. C. F. Phillips.

Members have noted exceptionally bad fading of 2LO in the vicinity during the last few days.

Local amateurs are informed by this Society that shortly an organised "sorting out" of radiating receivers will commence in view of the occurrence of repeated exhibitions of chronic radiation from autodyne receivers.

East London Radio Society.*

Hon. Secretary, Mr. L. E. Lubbock, King George's Hall, East India Dock Road, Poplar.

Some 30 members attended on November 14th. The Vice-Chairman, Mr. A. J. Alexander, was in the chair.

Attention was given to 2MT. The opinion of the Society is that each transmission by this station is an improvement upon the last.

The Management Committee has received many requests from the newer members for a few more elementary lectures than have been recently given. In response to this request Mr. W. C. Wells lectured upon "The Construction of a Single Valve Panel." His lecture proved very instructive to those yet in the elementary stage, and very interesting to those already past that stage. The evening closed with votes of thanks to the lecturer and chairman at 10 p.m.

Although membership increases week by week, yet more will be welcome. The Society meets at the Lecture Hall, Woodstock Road, every Tuesday and Friday.

Wakefield and District Wireless Society.*

Hon. Secretary, Mr. E. Swale, 11, Thornes Road, Thornes, Wakefield.

On November 10th, Mr. Wigglesworth, Hon. Secretary of the Barnsley Wireless Society, gave an interesting paper entitled "A Universal Three Valve Set." The switching for various numbers of valves was explained and an attempt was made at demonstration; this, however, was not very successful owing to the inefficiency of the rough aerial. Permanent quarters are being established at the Technical School at once, where an efficient aerial will be erected and gear installed.

On November 17th, the President (Mr. H. H. T. Burbury) and his son brought apparatus and described what was to the members an entirely new circuit. On November 24th, two members, Mr. A. Cobbett and Mr. F. Wakefield, brought their sets and described them very lucidly.

The meetings of the Society will in future be held on Thursday evenings instead of Fridays.

Wireless and Experimental Association.*

Hon. Secretary, Mr. Geo. Sutton, 18, Melford Road, S.E.22.

On November 22nd there was a crowded and enthusiastic meeting.

The Secretary gave details of his work at Sir Frederick Hall's committee rooms on the previous Wednesday evening, and the Committee of members who had attended to the details of the Association's display and assistance at St. Saviour's Church at Herne Hill on the 16th, 17th and 18th, detailed their experiences.

Messrs. Hersey and Voigt discoursed on the subject of heterodyne and reaction circuits. Mr. Knight, the Chairman, discovered several very simple mechanical analogies, which he described with the aid of the blackboard, and Mr. Hunter exhibited and explained a very comprehensive wavemeter which he had constructed.

Plymouth Wireless and Scientific Society.

Hon. Secretary, Mr. G. H. Lock, 9, Ryder Road, Stoke, Devonport.

In the absence of Mr. Arberry through illness, Mr. Penney continued his lecture on "Valve Receiving Circuits." Dealing first with the difference in the reception of damped and continuous waves, the lecturer explained the heterodyne principle and beat reception. A very hearty vote of thanks was accorded to Mr. Penney.

On Wednesday, November 22nd, a demonstration of telegraphy and telephony was given at a Bazaar and Fête in aid of the funds of the Service Men's Y.M.C.A. With a seven-valve set and Magnavox, belonging to Mr. F. S. Heal, the 5.10 concert and weather report from Paris was made audible to a large audience. In the main hall of the building, through the kindness of Messrs. Tregilgas, Gundry, Brand and Lock, quite a good exhibition of modern wireless receiving apparatus was given.

Birmingham Experimental Wireless Club.*

Hon. Secretary, Mr. A. L. Lancaster, c/o Lancaster Bros. & Co., Shadwell Street, Birmingham.

At a general meeting of the above Club on November 24th, the following new officers were elected:—Hon. Treasurer, Mr. Matthews, Westgate, Frederick Road, Wyde Green, Birmingham; Hon. Secretary, Mr. A. L. Lancaster; Hon. Librarian, Mr. H. A. Jennings, Ladywood Road, Birmingham.

A vote of thanks for work done was unanimously passed to the retiring officers, and it was announced that the comprehensive programme is being arranged for the Session.

Belvedere and District Radio and Scientific Society.*

Hon. Secretary, Mr. S. G. Meadows, 1, Kentish Road, Belvedere, Kent.

The fourteenth general meeting was held at headquarters (Erith Technical Institute) on November 24th. The Secretary read a document from the G.P.O. authorities on the status of the experimenter, as against that of the "broadcaster." Mr. T. E. Morris gave an impression of his visit to the Wireless Society of London's Meeting, on November 22nd, and read a paper on "Amplification, orthodox and unorthodox."

Questions were postponed till the next meeting. The equipment engineer connected up the receiving set and loud speaker, and 2LO was received clear and strong.

Radio Society of Birkenhead.

Hon. Secretary, Mr. R. Watson, 35, Fairview Road Oxtou, Birkenhead.

The Committee of the Radio Society of Birkenhead so far consists of the following:—Vice-President, Mr. W. Watts; Chairman, Mr. R. T. Goodyear, B.A.; Hon. Secretary, Mr. R. Watson; Hon. Treasurer, Mr. G. A. King; Technical Advisers, Mr. H. I. Hughes and Mr. B. Austin. Several other gentlemen have been asked to join the Committee, and the Secretary is awaiting their replies.

On the opening night, November 21st, there were about forty-five present, and a number of ladies attended. Mr. Watts, Vice-President, occupied the chair, and also lectured on "The Progress of Wireless." He referred to his first demonstration of wireless which he gave in the nineties, and how it was a complete failure owing to a wire in the induction coil being fused. However, the second demonstration which he gave at Wrexham in the same year was a magnificent success.

A demonstration of radio-telephony from the Manchester broadcasting station was given by Mr. Austin on his four-valve home-made set, and excellent telephony was made audible by means of a loud speaker lent by Mr. Hughes.

Meetings will take place every first and third Thursday.

South London Wireless and Scientific Club.

Hon. Secretary, Mr. W. G. Ansell, 69, Larcom Street, S.E.17.

At the meeting on November 20th, the chief item of interest was the welcoming back of the Chairman, Capt. de Villiers, who had been in the provinces seven weeks demonstrating his wireless controlled airship. He gave a discourse on the difficulties he had experienced in various towns in the arranging of suitable aerials, and the marked contrast in the results on aerials arranged under varying local conditions and his methods of overcoming same. He also outlined the various amateur stations he had seen, and related points of interest as given by the provincial amateurs in relation to transmission generally and London transmissions in particular; between the various transmitting stations and the results obtained when "listening in" from other towns. A long discussion followed on the various points.

The seven-valve set which is being made for the Society is almost complete.

Blackburn and District Radio and Scientific Society.

Hon. Secretary, Mr. E. A. Pollard, Spring Bank, Limefield, Blackburn.

In the Old Bull Hotel on November 17th, a Technical Committee was formed to whom all technical problems will be submitted.

A programme of lectures will be drawn up for the winter months and arrangements are to be made for members to visit places of general interest to them, including the broadcasting station at Manchester.

Members of the club will be divided into three sections, namely (1) Full members; (2) Associate members; (3) Persons under 16 years of age. This will comprise the junior section. The fees for membership are £1, 10s. and 5s. respectively.

Northampton and District Amateur Radio Society.

Hon. Secretary, Mr. S. H. Barber, M.B.E., 51, College Street, Northampton.

At the Exchange Cinema on November 21st, Mr. John Reid occupied the chair, and briefly outlined the history of the Society. He pointed out that already two successful meetings had been held, at which a provisional chairman and vice-chairman had been appointed, who had formulated the proposed rules and constitution of the Society. He acknowledged the services rendered by Mr. S. H. Barber as hon. secretary *pro tem.* and by Mr. A. E. Turville for his kindness in allowing the Committee to meet in his house. It was suggested to arrange a programme for the immediate winter months of a few lectures and demonstrations, which should be elementary. Capt. Tissington and Mr. Frank Turville had volunteered to be Morse tutors. The formation of the classes is in the hands of the Committee.

Mr. S. S. Barber read the recommended constitution and rules of the society, which were adopted. All persons over 18 years are admitted as full members for 10s. 6d., and under 18 as juniors at 5s. a year.

The election of officers resulted as follows: Hon. president, the Mayor of Northampton (Alderman C. Earl); chairman, Mr. J. Reid; Vice-Chairman, Mr. A. E. Turville; Hon. Secretary, Mr. S. H. Barber, M.B.E.; Hon. Treasurer, Mr. H. P. Howe; Committee, Messrs. Pinder, F. Turville, K. Cobb, Nightingale, Wood, Archer, Swann, Billson, Smith, and Tomlinson.

It was decided for the present to meet weekly on Mondays at the Exchange Cinema.

Ipswich and District Wireless Club.

Hon. Secretary, Mr. H. E. Barbrook, 46 Foundation Street, Ipswich.

Dr. S. A. Nottcutt, B.A., LL.D., took the chair at the Annual Meeting on November 20th.

The Secretary's and Treasurer's report showed a small balance in hand. Headquarters are now settled at 55, Fonnereau Road.

The new constitution of the Society, is as follows: President, Dr. S. A. Nottcutt, B.A., LL.D.; Vice-Presidents, Messrs. R. S. Lewis and F. Mellor; Secretary, Mr. H. E. Barbrook; Treasurer, Mr. F. A. Page.

Battersea and District Radio Society.

Hon. Secretary, Mr. Francis J. Lisney, 66, Newland Terrace, Queen's Road, S.W.8.

The first general meeting to discuss the formation of a Radio Society, was held at the Temperance Billiard Hall, Wandsworth Road, S.W.8., on November 24th. Being the first meeting, the number present was good, viz., 23. The following officers were elected:—Mr. G. W. Henley, Chairman; Mr. Francis J. Lisney, Hon. Secretary; Mr. W. F. Pope, Treasurer; Messrs. Wm. Oakley, G. P. Phillips, W. J. Houston, H. R. Howling, Committee.

Several resolutions were passed, which the Committee considered after the meeting, so as to bring into motion at the next meeting.

Mr. H. R. Howling promised to bring some apparatus to the next meeting.

No settled meeting programme has been arranged, until the Society has obtained permanent headquarters.

Mount Pleasant Radio Society.

Hon. Secretary, Mr. Walter R. Fleming, 156, Upton Park Road, Forest Gate, E.7.

The first meeting in the new headquarters was held on October 26th. It was proposed and carried that Rule 3 should be deleted. This rule stated that the membership should consist of Civil servants only. The Society now extends its invitation to all who are interested in Radio.

On November 3rd a meeting was held at headquarters, when Mr. W. D. Keiller (technical adviser to the Society) gave a lecture on "Simple Receiving Circuits," which was illustrated with blackboard sketches, and proved very helpful.

A meeting was held on November 10th, and an informal discussion took place and several knotty problems of members were solved.

On November 17th the weekly meeting was held, the Vice-President, Mr. A. Hinderlick, M.A., taking the chair. The President, Mr. W. E. F. Corsham, gave his Presidential address. He gave an interesting account of his experiences in communicating with American amateur stations, and said that he found that the best signals were received during bad stormy weather. In closing his address he said he would be transmitting on 210 metres at 10.30 a.m. for test purposes, and would be pleased to hear from members as to how they had received 2 UV.

Following the President's address, Mr. W. D. Keiller gave his continued lecture on "Simple Receiving Circuits (Constructional Details)." This proved extremely interesting and helpful to new members. Both the President and Mr. W. D. Keiller were accorded votes of thanks.

On November 24th Mr. W. A. J. Smith gave a demonstration with a Mark III tuner which was kindly lent by the Vice-President, Mr. U. Beaton.

Several new members and associates have been enrolled.

Eastern Enfield Wireless and Experimental Society.

Hon. Secretary, Mr. Arthur I. Dabbs, 315, High Road, Ponders End, N.

Arrangements were discussed on November 23rd for a series of lectures, and it was decided that the Secretary should commence lectures on the elementary theory and practice of wireless telegraphy and telephony at the next meeting.

A member brought up a home-made crystal set which was tested on the Society's aerial and was proved to be a success.

The Broadcasting programmes have given a spurt to the members' activities. Licence problems were discussed.

Finchley and District Wireless Society.

Hon. Secretary, Mr. A. E. Field, 28, Holmwood Gardens, Finchley, N.3.

On November 27th the above Society met, when it was found that owing to pressure of business Messrs. Burndept, Ltd., were unable to give their promised lecture and demonstration. However, Mr. H. Trussler kindly brought up a single valve set which he demonstrated. He also exhibited some very novel filament resistances which have just been invented.

On December 11th the Society held its Carnival Dance. Members are still urgently needed, those interested in any way are asked to communicate with the Hon. Secretary.

Working Men's College Wireless Club.

Hon. Secretary, Mr. A. Fryatt, Working Men's College, Crowndale Road, N.W.

The above Club held its second annual wireless and X-ray exhibition on October 28th. Thanks were expressed to Mr. Burnham (2 FQ), Blackheath, for his kindness in transmitting a concert which was received very well, except when the X-ray coil was working, which interrupted reception slightly. Messrs. A. G. Wright & Co., of Kentish Town, were thanked for lending broadcasting apparatus and Messrs. S. G. Brown & Co. for the loan of a loud speaker.

Watford and District Radio Society.

Hon. Secretary, Mr. F. A. Moore, 175, Leavesden Road, Watford.

Meetings were held at headquarters, the National Schools, Watford, on November 27th and Wednesday, November 29th.

The principal item of interest at the former meeting was a lecture by Mr. Goodwin on "The Winding of Telephones and Transformers."

The lecturer dealt with the subject in a most able and interesting manner, and a vote of thanks, proposed by Mr. Foxen, was heartily accorded him.

The second meeting was made attractive by a lecture by the Hon. Treasurer, Mr. E. L. Leader on "The History of My Two-Valve Set." He explained the various circuits he had used and the results he had obtained on each. A hearty vote of thanks to Mr. Leader concluded the meeting.

Chorleywood and District Wireless Society.

Hon. Secretary, Mr. A. G. S. Richards, Hillbrow, Haddon Road, Chorleywood.

A very successful inaugural meeting of the Society was held on November 27th. Mr. W. Blake was elected Chairman and Mr. A. G. S. Richards was elected Secretary.

A committee has been formed consisting of the Chairman and Secretary, together with Messrs. Craske and Watkins, for the purpose of drawing up a programme.

The Society meets every Monday evening at the Secretary's residence, Hillbrow, Haddon Road, Chorleywood, and all interested are invited to communicate with him as above.

Scarborough and District Wireless Club.

Hon. Secretary, Mr. F. Bulmer, 4, Carlton Terrace, Scarborough.

The first annual meeting was held on December 1st at the Club's rooms, 38b, Falsgrave Road.

Dr. Rhodes took the chair. The meeting was well attended. The Hon. Secretary presented his annual report which was well received. The Hon. Treasurer reported a balance in the bank. It was resolved to remove the headquarters to a more central position.

A cordial vote of thanks was tendered to the retiring Hon. Secretary and Hon. Treasurer, which was suitably responded to.

A whist drive and dance was held on December 8th at Rowntree's Esplanade Café.

Radio Society of Tavistock.

Hon. Secretary (*pro tem.*), Mr. Albert E. Graves, 2, Parkwood Road, Tavistock.

The above Society is in process of formation. Will any gentlemen who are interested, either beginners or experts, communicate with the Hon. Secretary.

Notes

Nice Heard on One Valve.

Mr. R. S. Elven, Hurst Lodge, Waverley Grove, Hendon, informs us that he received 8 AB on November 30th, when that station was working to 8 AE and 2 AW. He used a single valve and separate heterodyne.

DUTCH PORTABLE SET.



The above photograph is contributed by Mr. E. A. Duitz and illustrates a Dutch portable field station in operation.

Reception and Transmission in Aeroplanes.

Captain W. G. R. Hinchcliffe maintained communication with Croydon at a distance of 275 miles, transmitting and receiving while piloting an aeroplane.

Wireless in School.

Bermondsey Guardians have agreed to install wireless apparatus at their Shirley Schools.

Wireless Controlled Aeroplane.

Promising results have been obtained from the experiments carried out at Etampes with aeroplanes controlled by wireless. Flights were made without a pilot, and also with a pilot, but using instead of the ordinary steering gear and engine control, the gyroscope stabiliser and the steering motors which will eventually be worked from the ground. The pilot was Captain Arbanère, and the experiments were carried out under the direction of MM. de Marcay, Bouche, and Percheron.

Canadian Broadcasting.

The executives of the Telephone Departments of the Western Provinces, including Alberta, have recommended that the Provincial Governments have control of Wireless Telephony. The recommendation, says *Canada*, is that stations be licensed by the Provincial Governments and that 50 per cent. of the licence fees go to the Dominion Government.

Swedish Broadcasting Company.

It is reported from Sweden that a broadcasting company is being formed.

New Marconi Director.

The Rt. Hon. F. G. Kellaway has been appointed a Director of Marconi's Wireless Telegraph Company, Limited.

New Chinese Stations.

American engineers arrived at Shanghai last month with the object of constructing a high-power radio station, with sub-stations at Khabin, Pekin and Canton. The Chinese Government is issuing bonds to cover half the cost, and will obtain possession of the stations in twenty years.

Cunard Wireless Officers.

Operators in the service of the Cunard Steamship Company are to be graded as officers, and will be employed direct by the Company. Senior operators will wear two gold bands with a green band in between on each arm, and rank as second officers, navigating branch. Junior operators will wear one gold band with a green band on each arm.



Dr. D. Bernardo Pavloni, of Montecassino, at work in his laboratory. He is at present conducting researches on atmospheric disturbances.

Song in Esperanto Broadcast.

On December 8th 2 LO broadcast a song in Esperanto. The Hackney and District Radio Society held a demonstration that evening and the Chairman, Mr. H. A. Epton, an Esperantist, lectured in that language.

The Transatlantic Tests.

ARRANGEMENTS FOR TRANSMISSION FROM THIS COUNTRY.

By Philip R. Coursey, B.Sc., F.Inst.P., A.M.I.E.E.

BY the time that this appears the first part of the Transatlantic Tests should be in progress. The second part, in which transmissions will be made from this country and from France to the American and Canadian amateurs, commences on December 21st-22nd, at midnight, and lasts until the 31st. As has already been announced in these columns, there will be a half-hour "free-for-all" period each night between the above-mentioned dates, the remainder of the time being allocated to the French transmissions and to individual transmission periods for those amateurs in this country who have qualified for them by previous long signalling ranges.

During the "free-for-all" periods any licensed amateur in this country may transmit if he wishes to do so. These transmissions should be made in the following form:

" **TEST TEST TEST DE** (Call letters 3 times)
GREAT BRITAIN," — • • • —

which should be repeated as often as necessary to fill the available time. Brief particulars of aerial current, etc., may be added if desired during the signalling period.

These "free-for-all" transmissions should preferably all be made on wavelengths between 180 and 200 metres, although 440 metres may also be used if desired. There will be a greater chance of being heard on the shorter wavelengths as the Americans will be listening most on those waves, but the American League have been advised that some of the "free-for-all" transmissions will be made on 440 metres.

Everyone who has not been allocated a special "individual" transmission period is asked to confine his signalling entirely to the above-mentioned "free-for-all" period of half-an-hour, so as to leave everything clear for the individual transmissions which follow.

The times of these "free-for-all" periods are as follows:—

TIME-TABLE OF "FREE-FOR-ALL" TRANSMISSION PERIODS.		
Duration of each period = $\frac{1}{2}$ hour.		
December	22nd	Midnight to 0030 G.M.T.
"	23rd	0300 to 0330 "
"	24th	Midnight to 0030 "
"	25th	0300 to 0330 "
"	26th	Midnight to 0030 "
"	27th	0300 to 0330 "
"	28th	Midnight to 0030 "
"	29th	0300 to 0330 "
"	30th	Midnight to 0030 "
"	31st	0300 to 0330 "

It should be remembered that in every case midnight is taken as belonging to the day just then commencing, and not to the previous day. Thus these transmission tests commence at midnight of December 21st-22nd, 1922.

The individual transmission periods will each be of 15 minutes' duration, and will continue for the $2\frac{1}{2}$ hours immediately following the above "free-for-all" periods. Full particulars of what is to be transmitted during these special periods will be sent by post to the stations concerned a few days before the commencement of the transmissions. All transmitting stations who have sent in adequate records of signalling range have been allotted "individual" periods, and will be advised by post of this allocation.

DAILY REPORTS.

The American Radio Relay League has arranged with the Radio Corporation of America and with Marconi's Wireless Telegraph Co. for daily reports of the reception of European stations in the United States or Canada to be transmitted by New Brunswick Radio Station (call letters **WII**) on a wavelength of 13600 metres at 2000 G.M.T. (i.e., 8.0 p.m.) each day. These reports will be sent at hand speed and will be repeated by Carnarvon Station (call letters **MUU**) on 14200 metres immediately on receipt. Therefore, by listening-in to these reports from New Brunswick or Carnarvon, everyone will be able to follow the progress of the tests, and learn each day which of our stations have been heard. These reports will include particulars of the reception of any French stations as well, since the French will be transmitting for three hours on each of the nights mentioned in the above programme.

Christmas Greetings by Wireless.

The watchers for the Northern Exploration Company who are stationed about 600 miles from the North Pole are to receive specially transmitted messages at Christmas.

"Radioletter" Service.

The Radio Corporation of American has announced a service to London and Germany at a rate slightly higher than postage. The rate announced is six cents per word with no minimum requirement. A message may be filed any day in the week up to Saturday with the designation "Radioletter" or its abbreviation "RL" and it will be transmitted in time to reach London or Germany the following Monday morning. While registered code addresses are acceptable, the text of the message is restricted to plain language only. The new service is called the "Radioletter" Service.

The Radio Society of Great Britain

PROGRAMME FOR TRANSATLANTIC RECEPTION TESTS.

DURATION OF THE RECEPTION TESTS.

Midnight to 0600 G.M.T., December 12th to 21st, 1922, inclusive.

FREE-FOR-ALL PERIODS.

Midnight to 0230 G.M.T. each night, divided up into 15-minute periods which are allocated to each of the U.S. Radio Inspection districts in turn.

"INDIVIDUAL" TRANSMISSION PERIODS.

0230 to 0600 G.M.T. each night, divided up into 15-minute periods which are allocated in turn to 14 groups of stations. All the stations in each group will transmit simultaneously during their appropriate 15-minute period.

CODE WORDS.

A special five-letter code word has been allocated to each of the stations transmitting during the "Individual Periods."

NUMBER OF STATIONS.

The Test Schedules of transmission which have just been received from America show that 324 U.S. Stations have qualified for the "individual" transmission periods, and these have been arranged into 14 groups—the number of stations included in each group which will be transmitting simultaneously during any one 15-minute period varying between 22 and 25 in different groups.

NATURE OF TRANSMISSIONS.

Over 98 per cent. of the stations will be sending on C.W., therefore listen in for C.W. all the time.

All transmissions will be in the form of a call addressed to "TEST TEST TEST de (call letters)," repeated as often as may be necessary to fill the 15-minute periods. The special code words will also be sent during the "individual" transmission periods.

WAVELENGTHS.

All stations, except thirteen special stations, will operate on wavelengths between 190 and 250 metres. Of these thirteen special stations,

three will use 275 metres; two will use 325 metres, and eight will use 375 metres. The times of transmission of these special wavelength stations are set out in the programme overleaf:—

REPORTS.

Everyone hearing signals which apparently are of American amateur origin during these test transmissions is requested to communicate FULL DETAILS immediately to:—

PHILIP R. COURSEY,
138, Muswell Hill Road,
London, N.10.

These reports should give exact times of the receptions, with details of the call letters, code words, etc., picked up, and should be forwarded either by letter or preferably by telegram, to the above address, or by telephone (except on Saturday and Sunday) to Hammersmith 1084 or to the *Wireless World* Offices, Gerrard 2807.

These reports are required quickly in order to avoid delay in preparing the text of the daily reports which are to be sent by Carnarvon Radio Station (call letters MUU) each morning at 0700 G.M.T. on a wavelength of 14,200 metres. These reports will be addressed to

"SCHNELL RADIOCORP NEW YORK"

(Mr. F. H. Schnell being the Traffic Manager of the American Radio Relay League), and will be sent at hand speed. They will be repeated by New Brunswick (WII) on 13,600 metres immediately afterwards. Reports of receptions of the American signals in France will be sent by Sainte Assise (UFT) on 14,300 metres, at 0710 G.M.T. each morning and will be repeated immediately afterwards by Marion (call letters WSO) on 11,500 metres.

PHILIP R. COURSEY,

On behalf of the Transatlantic Tests Sub-Committee of the Radio Society of Great Britain.

December 4th, 1922.

Programme of Transmissions from U.S.A. and Canada giving times of each group of transmissions for each night during the tests.

Nature of Transmissions.	Wavelengths (metres).	December 12th. Time—G.M.T.	December 13th. Time—G.M.T.	December 14th. Time—G.M.T.	December 15th. Time—G.M.T.	December 16th. Time—G.M.T.	December 17th. Time—G.M.T.	December 18th. Time—G.M.T.	December 20th. Time—G.M.T.	December 21st. Time—G.M.T.
15-minute "Free-for-all" periods	190 to 375	0000 to 0230	0000 to 0230	0000 to 0230	0000 to 0230	0000 to 0230	0000 to 0230	0000 to 0230	0000 to 0230	0000 to 0230
22 Individual Transmissions	190 to 250 275 375	0230 to 0245	0545 to 0600	0530 to 0545	0515 to 0530	0500 to 0515	0445 to 0500	0415 to 0430	0400 to 0415	0345 to 0400
22 Individual Transmissions	190 to 270 275 375	0245 to 0300	0230 to 0245	0545 to 0600	0530 to 0545	0515 to 0530	0500 to 0515	0445 to 0460	0415 to 0430	0400 to 0415
22 Individual Transmissions	190 to 250 275 325	0300 to 0315	0245 to 0300	0230 to 0245	0545 to 0600	0530 to 0545	0515 to 0530	0445 to 0460	0430 to 0445	0415 to 0430
22 Individual Transmissions	190 to 250 275	0315 to 0330	0300 to 0315	0245 to 0300	0545 to 0600	0530 to 0545	0515 to 0530	0445 to 0460	0430 to 0445	0415 to 0430
22 Individual Transmissions	190 to 250 275 375	0330 to 0345	0315 to 0330	0300 to 0315	0545 to 0600	0530 to 0545	0515 to 0530	0445 to 0460	0430 to 0445	0415 to 0430
22 Individual Transmissions	190 to 250 275 375	0345 to 0400	0330 to 0345	0315 to 0330	0545 to 0600	0530 to 0545	0515 to 0530	0445 to 0460	0430 to 0445	0415 to 0430
23 Individual Transmissions	190 to 250 275 375	0400 to 0415	0345 to 0400	0330 to 0345	0545 to 0600	0530 to 0545	0515 to 0530	0445 to 0460	0430 to 0445	0415 to 0430
22 Individual Transmissions	190 to 250	0415 to 0430	0400 to 0415	0345 to 0400	0545 to 0600	0530 to 0545	0515 to 0530	0445 to 0460	0430 to 0445	0415 to 0430
22 Individual Transmissions	190 to 250	0430 to 0445	0415 to 0430	0400 to 0415	0545 to 0600	0530 to 0545	0515 to 0530	0445 to 0460	0430 to 0445	0415 to 0430
22 Individual Transmissions	190 to 230	0445 to 0500	0430 to 0445	0415 to 0430	0545 to 0600	0530 to 0545	0515 to 0530	0445 to 0460	0430 to 0445	0415 to 0430
22 Individual Transmissions	190 to 250	0500 to 0515	0445 to 0500	0430 to 0445	0545 to 0600	0530 to 0545	0515 to 0530	0445 to 0460	0430 to 0445	0415 to 0430
22 Individual Transmissions	190 to 250	0515 to 0530	0500 to 0515	0445 to 0500	0545 to 0600	0530 to 0545	0515 to 0530	0445 to 0460	0430 to 0445	0415 to 0430
22 Individual Transmissions	190 to 250	0530 to 0545	0515 to 0530	0500 to 0515	0545 to 0600	0530 to 0545	0515 to 0530	0445 to 0460	0430 to 0445	0415 to 0430
22 Individual Transmissions	190 to 250	0545 to 0600	0530 to 0545	0515 to 0530	0545 to 0600	0530 to 0545	0515 to 0530	0445 to 0460	0430 to 0445	0415 to 0430

NOTE.—Times are reckoned in Greenwich Mean Time (G.M.T.), midnight being shown as 0000 of the day just then beginning. Thus: the commencement of the Tests is at midnight of December 11th-12th, 1922.

NOTE.—Unfortunately the information from which the above table was compiled was not received from America until too late for inclusion in last week's issue. Consequently the tests have actually commenced as this issue appears. All those, however, who have entered for the tests have been circularised with this information through the post.—Ed.

Calendar of Current Events

Friday, December 15th.

BRADFORD WIRELESS SOCIETY.

At 5, Randallwell Street, Bradford. Lecture by Mr. S. Davies (Dewsbury).

BELVEDERE AND DISTRICT RADIO AND SCIENTIFIC SOCIETY.

Discussion on "The Difficulties Experienced by the Radio Amateur," opened by Mr. S. G. Meadows.

LEEDS AND DISTRICT AMATEUR WIRELESS SOCIETY.

At 7 p.m. At the Grammar School. Lecture by the Secretary, Mr. D. E. Pettigrew, on "Resistance, Inductance and Capacity in A.C. Circuits."

DURHAM CITY AND DISTRICT WIRELESS CLUB.

At 7.30 p.m. At the Y.M.C.A., Claypath. Lecture on "Wireless Telephony Transmitters Using Valves," by Mr. Geo. Barnard.

NORTH-EAST COAST INSTITUTION OF ENGINEERS AND SHIPBUILDERS.

At 7.30 p.m. In the Lecture Theatre of the Literary and Philosophical Society, Newcastle-on-Tyne. Lecture on "Wireless Broadcasting and its Possibilities," by Mr. A. P. M. Fleming.

MAIDSTONE AND DISTRICT RADIO SOCIETY.

At 8 p.m. At the Pavilion Athletic Ground, Maidstone. General Meeting.

WOOLWICH RADIO SOCIETY.

At 8 p.m. At Woolwich Polytechnic. Lecture and Demonstration on "Wireless Mast Construction," by Capt. C. T. Hughes, R.E.

Saturday, December 16th.

At 7.30 p.m. At Westfield House, Sunderland. Lecture on a "Propagation of Electro-Magnetic Waves," by Dr. J. A. Wilcken.

Sunday, December 17th.

3-5 p.m. *Daily Mail* Concert from PCGG, The Hague, on 1,050 metres.

Monday, December 18th.

9.20-10.20 p.m. Dutch Concert, PCGG. The Hague, on 1,050 metres.

FINCHLEY AND DISTRICT WIRELESS SOCIETY. Dance.

HORNSEY AND DISTRICT WIRELESS SOCIETY.

Demonstration and Lecture by Mr. Hodges.

IPSWICH AND DISTRICT WIRELESS SOCIETY.

At 8 p.m. At 55, Fonnereau Road. Open Meeting.

Tuesday, December 19th.

Transmission of Telephony at 8 p.m., on 400 metres, by 2 MT Writtle.

LOWESTOFT AND DISTRICT WIRELESS SOCIETY.

Lecture to be given by Telephony, by Mr. Chipperfield from 2 MD.

PLYMOUTH WIRELESS AND SCIENTIFIC SOCIETY.

Question Night.

Wednesday, December 20th.

RADIO SOCIETY OF GREAT BRITAIN.

At 6 p.m. At the Institution of Electrical Engineers, Victoria Embankment. Annual General Meeting and Election of Officers. Paper on "Civil Airship Wireless during 1922," by Lieut. Duncan Sinclair (Air Ministry).

EDINBURGH AND DISTRICT RADIO SOCIETY.

At 8 p.m. At Headquarters. Lecture on "Soldering," by Mr. W. Todd. (No meetings on 27th and Jan. 3rd).

MANCHESTER WIRELESS SOCIETY.

At 7.30 p.m. At Houldsworth Hall. Discussion.

MALVERN WIRELESS SOCIETY.

Lecture on "Detection of Wireless Signals." REDHILL AND DISTRICT Y.M.C.A. WIRELESS SOCIETY.

At 111, Station Road, Redhill. Lecture on "Calculations."

Thursday, December 21st.

At 9.20-10.20 p.m. Dutch Concert from PCGG The Hague, on 1,050 metres.

DERBY WIRELESS CLUB.

At 7.30 p.m. At "The Court," Alvaston. Lecture on "Land Line Telephones," by Mr. F. V. Taylor.

HACKNEY AND DISTRICT RADIO SOCIETY.

Lecture and Demonstration on "Spark Coils and H.F. Currents (Tesla)," by Mr. A. Valins.

RADIO SOCIETY OF BIRKENHEAD.

At 8 p.m. At 36, Hamilton Square (top floor). General Meeting.

CARDIFF AND SOUTH WALES WIRELESS SOCIETY.

At 7.30 p.m. At the Engineers' Institute, Park Street, Cardiff. Lecture on "Direction Finding by Wireless," by Mr. K. Fawcett.

Friday, December 22nd.

WIRELESS SOCIETY OF HULL AND DISTRICT.

At 7.30 p.m. At Signal Corps Headquarters, Park Street. Questions and Answers.

LEEDS AND DISTRICT AMATEUR WIRELESS SOCIETY. Dinner.

Proposed Society for Bexley Heath.

Mr. L. W. Smith and Mr. J. P. Prangnell are endeavouring to form a Wireless Society in their district. Enquiries should be addressed to them at "The Chestnuts," Erith Road, Bexley Heath.

The Queen Listens-in.

Her Majesty the Queen, while visiting Harrod's Stores on a shopping tour, took the opportunity to listen-in at a wireless demonstration which was in progress at the time.

An Exhibition.

The third annual exhibition of the Chester Y.M.C.A. Society of Model and Experimental Engineers will be held in the Old Palace, Chester, on December 16th, from 2 to 10 p.m. Exhibits will include wireless apparatus and demonstrations in the reception of wireless telegraphy and telephony will be given with the aid of the Society's seven-valve set. Admission free.

5 HA Birkenhead.

The Hon. Secretary of the Radio Society of Birkenhead, Mr. R. Watson, has been registered as a transmitter. His call letters are 5 HA, wavelength 150-200 (spark, C.W. and telephony). He has a fixed wave of 440 metres for C.W. and telephony only.

Questions and Answers

NOTE.—This section of the magazine is placed at the disposal of all readers who wish to receive advice and information on matters pertaining to both the technical and non-technical sides of wireless work. Readers should comply with the following rules:—(1) Each question should be numbered and written on a separate sheet on one side of the paper, and addressed "Questions and Answers," Editor, THE WIRELESS WORLD AND RADIO REVIEW, 12/13, Henrietta Street, London, W.C.2. Queries should be clear and concise. (2) Before sending in their questions readers are advised to search recent numbers to see whether the same queries have not been dealt with before. (3) Each communication sent in to be accompanied by the "Questions and Answers" coupon to be found in the advertisement columns of the issue current at the time of forwarding the questions. (4) The name and address of the querist, which is for reference and not for publication, to appear at the top of every sheet or sheets, and unless typewritten, this should be in block capitals. Queries will be answered under the initials and town of the correspondent, or, if so desired, under a "nom de plume." (5) In view of the fact that a large proportion of the circuits and apparatus described in these answers are covered by patents, readers are advised before making use of them, to satisfy themselves that they would not be infringing patents. (6) Where a reply through the post is required, every question sent in must be accompanied by a postal order for the amount of 1s., or 3s. 6d. for a maximum of four questions. (7) Four questions is the maximum which may be sent in at one time.

"W.N.G." (Dovercourt) asks (1) Whether, when a circuit using the usual reaction arrangements is oscillating, energy is being radiated. (2) How to know when the set is radiating energy. (3) Whether, when the reaction coil is tightly coupled and a howling is heard in the receivers when receiving a signal, energy is being radiated. (4) Whether the wavelength of the energy being radiated is the same as the wavelength of the signal being received.

(1) Energy is certainly being radiated when the set is oscillating and the reaction coil is coupled to either the closed or open circuit inductances. (2) If radiation is taking place, touching the aerial terminal will cause a loud pop in the receivers. (3) When the set is oscillating and the reaction coil is coupled to the aerial or closed circuit inductances, you may be sure energy is being radiated and all listeners in within a radius of probably five miles are being disturbed and annoyed. (4) The energy is radiated on a wavelength close to that of the signal which is being received, and other experimenters who are listening to the same transmissions as yourself are being seriously interfered with.

"F.H.B." (Liverpool) asks (1) For a diagram of a three-valve set using switches. (2) and (3) For particulars of L.F. transformer. (4) For particulars of H.F. transformer.

(1) We suggest you use the circuit on page 883, September 30th issue. (2) and (3) The L.F. transformer should be constructed exactly as described on page 659, August 19th issue. (4) Make up a number of plug-in type H.F. transformers. Suitable values are: bobbin 2½" to 3" diameter, with 50, 100, 250, 400, 650, 1,000 and 2,500 turns for primary and secondary.

"MARCUS" (Dublin) asks for criticism of his circuit, which is used for amplifying small sounds.

The proposed arrangement is correct, but we think you will not get satisfactory results unless you employ five valves. The telephones which are shown connected in the plate circuit of the valve should be of the high resistance type; 4,000 ω . would be suitable.

"R.A.L." (Middlesex) asks for a diagram of a single circuit crystal receiver.

See Fig. 1. Coarse tuning is effected with the coarse tuning switch, and fine adjustments are made with the fine tuning switch. To receive long wavelengths a coil should be inserted at the point marked in the figure. The winding should be of No. 24 D.C.C. on a former 3" diameter.

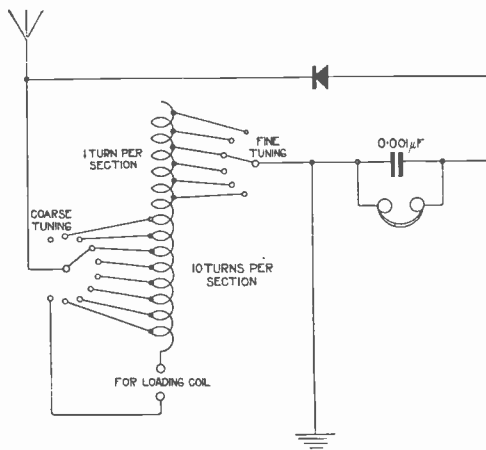

Fig. 1.

"L.C.K." (Essex) asks (1) For particulars of a telephone transformer. (2) For particulars of a transformer to couple a crystal detector with the input circuit of a valve. (3) Size of former potentiometer.

(1) The bobbin proposed is much too small. We suggest you make the core ½" diameter and 3" long. The primary could consist of 3 ozs. of No 44 S.S.C. wire wound on first, and the secondary 4 ozs. of No. 34 S.S.C. (2) The transformer may consist of a core ½" diameter and 3" long. The primary winding may be 1½ ozs. No. 44 S.S.C., and the secondary 4 ozs. of No. 44 S.S.C. (3) If the potentiometer is to have a resistance of 250 ω , and No. 36 gauge German silver wire is to be used, the winding length should be 6" and the former ½" diameter.

"INDUCTANCE" (Stockwell).—(1) We suggest you make up six basket coils for the A.T.I. Each coil may consist of 40 turns of No. 26 D.C.C. wire with a mean diameter of $2\frac{1}{2}$ ". The reaction coil may consist of four such coils. These should be connected in series and the tapings brought out to a switch. Each coil should be spaced $\frac{1}{8}$ " to reduce self capacity. (2) The capacity of the condenser is about 0.0006 mfd.

"AERIAL" (Huddersfield), asks (1) For advice as to his aerial. (2) What telephony he will receive using a single valve set. (3) Whether he will require a buzzer to adjust the crystal if he uses a H.F. valve and crystal combination.

(1) The proposed arrangement, 30 degs. with the telephone wires, is better. (2) You may expect to hear the local amateur transmission and broadcast transmissions. (3) The buzzer will not be useful. We suggest you connect up according to Fig. 2, page 183, November 4th issue. The 0.0005 mfd. variable condenser is quite suitable.

"D.C.B." (Sheffield) asks (1) Whether a tapped coil may be used for the anode coil of a H.F. valve. (2) Whether better results are obtained when an anode resistance is used. (3) What H.T. volts to use. (4) Whether a 2 mfd. fixed condenser is too large to connect across the H.T.

(1) You may, of course, use a tapped coil in the anode circuit of a H.F. connected valve, or you could use several plug-in coils. The coil should be tuned with a variable condenser of maximum value 0.0002 mfd. (2) For wavelengths above 2,000 metres we suggest you use the resistance or capacity method of H.F. coupling. (3) A suitable anode resistance would be one of 80,000 ohms and as this is the approximate resistance of the valve the H.T. volts should be about doubled. (4) A fixed condenser of about 2 mfd. is not too large, but you should be quite sure it is able to withstand the H.T. potential.

"H.T.L." (S.E.7) asks (1) For particulars of the construction of an intervalve transformer. (2) For particulars of the construction of a telephone transformer.

(1) The core should consist of a bundle of iron wires $9\frac{1}{2}$ " long, built up to a diameter of $7\frac{1}{16}$ ". The cheeks are 2" diameter and $7\frac{1}{16}$ " thick. The cheeks have four small holes for the ends of the coils. In one cheek drill holes $\frac{1}{4}$ " and $\frac{1}{2}$ " from the centre, and in the other the holes are $9\frac{1}{16}$ " and $\frac{3}{8}$ " for the centre. One edge of each cheek is bevelled, and they are mounted 2" apart on the coil. Two layers of empire cloth are wrapped on the core and the primary winding of No. 46 S.S.C. is wound on until the diameter is $13\frac{1}{16}$ ". Three layers of empire cloth are wound over the winding, and the secondary winding of No. 46 S.S.C. is wound until the diameter is $1\frac{1}{4}$ ". Five layers of wire in all are required. The transformer is completed by turning back and fastening the ends of the core. (2) The telephone transformer is made in a similar manner, but the secondary wire is 4 ozs. of No. 34 S.S.C.

"G.I.E." (Pontypridd).—It would require a great deal of space to describe each of the types of coil to which you refer, and the whole subject is very fully dealt with in "The Radio Experimenter's Handbook," by Coursey. A pancake coil is constructed by winding wire in and out of a single row of pegs fastened to a cylindrical former. A lattice winding is a winding wound on a cylindrical former, and the wire crosses from side to side several times during one turn, and only one turn is wound per layer. The honeycomb coil is similar to the lattice coil, but the wire passes from one side to the other in about half the circumference, and then passes back again to the first face, arriving there a small distance to one side of the starting point. The winding is carried on until one layer is completed, when the next wire lies directly over the first turn in the first layer. The wires are spaced, because they cross over the turns in the first layer. The duolateral coil is a special form of honeycomb coil, in which alternate layers lie exactly over one another. A uni-wave coil is a coil in which the wire is given a back and forward motion while being wound, and is a machine-wound coil.

"H.L.P." (Salop).—When choosing a suitable L.F. intervalve transformer, there are several considerations which should be borne in mind. Generally, a transformer is a power operated device, and its function when connected in a valve circuit is (1) the primary winding should be designed so that the maximum amount of energy is available for transferring to the secondary winding, and (2) the ratio of windings should be such that the highest voltage is impressed across the input of the next valve. Condition (1) demands that the impedance of the transformer is approximately equal to the plate-filament impedance of the valve to which it is connected. This can only be secured when a large number of turns are used for the primary winding. Condition (2) is fulfilled when the secondary consists of the largest number of turns, consistent with the voltage produced across it. The number of turns which can be effectively used in this winding is limited by the self-capacity. The turns ratio of the windings is not always a sure guide, neither is it safe to pay too much attention to the resistance of the windings. Resistance is an evil, but unfortunately it is always rather high, as the windings must be of very fine wire. It can only serve as a guide when comparing transformers of similar dimensions. Other points to consider are the current carrying capacity of the windings, and the insulation. A good ratio of primary to secondary turns is 1-2. The best transformers are generally the most expensive, and you should purchase from a firm of wireless engineers with a good reputation. You should be able to decide on the type of H.F. transformer yourself. If you use plug-in H.F. transformers, there is the trouble of having a number of transformers, and the difficulty of tuning in; on the other hand, tapped self-tuned transformers are not so efficient, but are much more convenient especially when several H.F. stages are in use. A large number of circuits have recently been given, and you should have no difficulty in choosing one to suit your requirements. The accumulators you have purchased are quite suitable.

The "BROWN" Loud Speakers

With New Improved Curved Horns

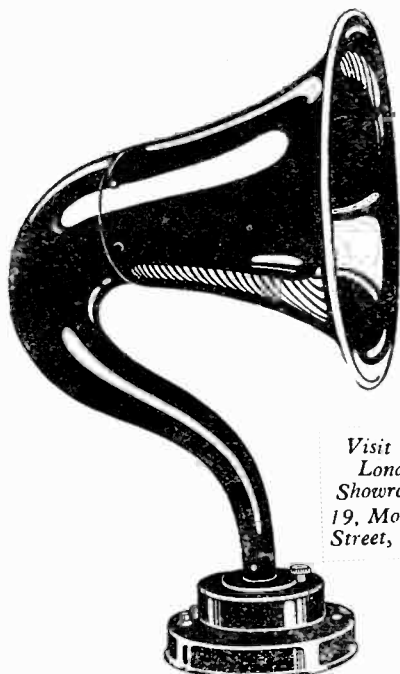

Visit Our
London
Showrooms:
19, Mortimer
Street, W.1

THE REQUISITES of a Loud Speaker are pure tone, clear articulation, and good volume of sound. The "BROWN" Loud Speaker possesses these qualities and they are enhanced by the new improved curved horn.

AMATEURS do not always need the full sized Loud Speaker (H.1) as used in Lecture Halls, and a small type (H.2) has been designed to meet their more modest home requirements both as to volume of sound and price.

THE NEW HORN of dull blacked aluminium used with both H.1 and H.2 is constructed on the logarithmic law of increasing openings and is acoustically perfect.

PRICES :

H.1 (Large) Low Resistance,
120 ohms, height 21" £6 5 0

H.2 (Small) Low Resistance,
120 ohms, height 12" £3 0 0

(High Resistances for either
size - - 2/6 to 5/- extra)

CATALOGUE POST FREE

THE "BROWN" MICROPHONE AMPLIFIER

THIS AMPLIFIER magnifies signals, speech, or music, without distortion, and is of considerable interest to amateurs and scientific investigators. This magnification is much greater than that obtained from a two-valve amplifier. In construction, this instrument

is much more robust than other relays. This instrument satisfies the urgent demand for a reliable, inexpensive amplifier, which the most inexperienced amateur can use, and which the most experienced requires. The necessary transformers are included in the base.

PRICES : Low Resistance (120 ohms input) £6 0 0
High Resistance (2,000 ohms) input 6 2 6

Illustrated Catalogue of our Headphones, Loud Speakers and Amplifier post free from—

S. G. BROWN, Ltd.
19, MORTIMER ST., LONDON, W.1

London Offices
and Showrooms

TRADE COMMUNICATIONS ONLY TO:—
HEAD OFFICE AND WORKS: VICTORIA ROAD, NORTH ACTON, LONDON, W.3
Telegrams—"Lidbrownix, London." Telephone—Chiswick 1469.
Sole Agent for the Argentine—Horacio D. Guerrero, Las Heras, 2486, Buenos Aires.

Convince yourself

on the quality and supreme merits of the

MAGNAVOX

The World's Finest Loud Speaker

by paying a visit to our showrooms and hearing its voice. Demonstrations given daily. See our exclusive and extensive range of radio apparatus.

To be obtained from all dealers or direct from the
Manufacturers & Sole Licensees

Sterling Telephone & Electric Co., Ltd.

210/212, Tottenham Court Road, London, W.1

Telephone No. : 4144 Museum (7 lines) Telegrams : "Cucumis, Wesdo, London."

Works : DAGENHAM, ESSEX.

BRANCHES : NEWCASTLE-ON-TYNE : 9, Clavering Place.
CARDIFF : 8, Park Place.

We guarantee that all Broadcast Radio Apparatus sold by us conforms with the conditions of the Broadcaster's Licence issued by the Postmaster-General.



No. R1282

RADIO brings it
MAGNAVOX tells it.

TOMLINSON

LONDON, LIMITED.

Demonstrations
Daily.

Demonstrations
Daily.

3, FINCHLEY RD., ST. JOHN'S WOOD, N.W.8
Hampstead 1844

A New 3-Coil Holder

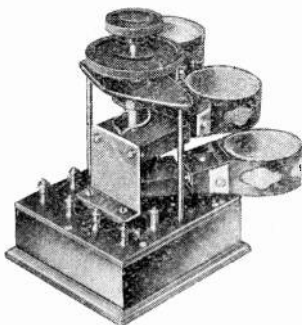

THREE-COIL HOLDER.

After considerable experimental work we have produced a Three-Coil Holder which combines extreme efficiency, neat appearance, easy adjustment and low cost.

In order to introduce this splendid instrument we are prepared to sell a limited number at the extremely low price of

20s.

Postage 9d.

Have you had your copy of our illustrated
Catalogue ?—2d. post free.



HEADPHONES

(British Made)
4,000 ohms. £1

"W.H.D." (Yorks).—We suggest you see the articles dealing with the Armstrong super-regenerative circuit which appeared in our issues of October 21st and 28th. When constructing a receiver of this type, the spacing of the components requires much care and experimenting, and to commence with, anyhow, it is better to follow the instructions given.

"J.B." (Nottingham) asks (1) Whether the core in his possession is suitable for use in a choke. (2) Referring to Fig. 3, page 714, September 2nd issue, are coils L_3 and L_4 coupled. (3) Using this circuit, what results should he expect, using a frame aerial. (4) What valves are the best in a circuit of this type.

(1) The core is quite suitable, and you should wind 5,000 turns of No. 38 S.S.C. wire. (2) These coils are coupled, but the position of the coils is a very important matter, and you should be careful to see the position of the coils is such that best results are secured. (3) Very good results are obtainable. Of course, you will not connect the set to an open type aerial. (4) "R" type valves give very good results.

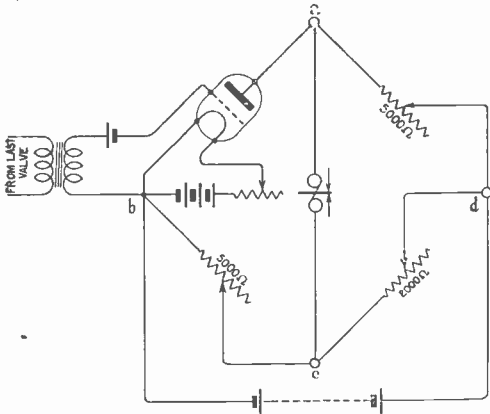

Fig. 2.

"SPARKS R.E." (Yorkshire).—We suggest you use the A.T.C. in series with the A.T.I. and add a few more turns to the reaction coil. As you remark, the aerial is very long for short-wave reception, and we suggest you try the set on a shorter aerial.

"F.P." (London).—(1) The correct values are, A.T.C., 0.001 mfd., anode tuning condenser 0.0002 mfd., grid condenser, 0.0003 mfd., grid leak 2mw., by-pass condenser, 0.001 mfd. (2) Duolateral coils are quite suitable. (3) The telephones should be of the H.R. type, or alternatively you could use a telephone transformer and L.R. telephones. (4) You would hear broadcast stations, high-powered stations, and amateur transmissions.

"R.D.C." (Middlesex).—The tellurium should be arranged in a similar manner to the steel of a carborundum detector, and the zincite would take the place of the carborundum.

"SUTHERLAND" (Cape Town) asks for criticism of his set.

The proposed arrangement is suitable, but the grid condenser should be 0.0003 mfd., and the L.R. telephones should not be connected directly in the anode circuit of the last valve. Either a telephone transformer must be used, or H.R. telephones must be employed. The reaction coil should be connected with the anode, and then the L.F. transformer. We think the intervalve transformer would be better if the primary winding consisted of 8,000 ohms, and the secondary 11,000 ohms.

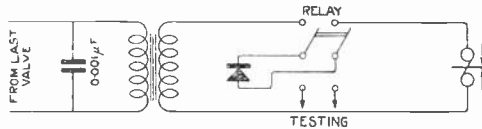

Fig. 3.

"W.B." (Somerset) has a Siemens relay and wishes to record signals.

The simplest method is to connect the relay as shown in Fig. 3, it being understood that signals have been rectified and amplified at L.F. The double pole throw-over-switch is shown connected for the purpose of testing the crystal. Another method with which very good results are possible is indicated in Fig. 2. The resistances AD and BC are variable in steps of 1,000 ohms, and the resistance CD in 100 ohms steps.

"GWENTELEPHONY" (Mon.)—(1) The proposed addition is quite suitable, and you should not experience any trouble in the construction or use of the receiver. (2) The variometer is not suitable for such a wide range of wavelengths, and we suggest the best thing to do is to wind the formers full of No. 22 D.C.C. wire and add a cylindrical tapped coil in series.

"B.B.B.H." (Blackheath) asks whether he can work a Siemens relay from a three-valve set.

The Siemens relay will operate with 0.1 milli-ampere and therefore will work well when connected to a three-valve set. The set should be arranged, two H.F. and one detector, and the relay should be joined in the output circuit of the detector valve.

"REJECTED" (Rotherham).—We suggest you abandon the arrangement, and use a normal system. A carefully adjusted normal circuit will give results which will satisfy your requirements.

"H.R.H." (Worcester).—(1) Several diagrams are given in recent issues, and you should have no difficulty in making a choice, bearing in mind the components in your possession. (2) The H.F. transformers should be provided withappings, and the reaction coil may couple with the grid winding. We suggest you use a number of basket coils, each coil having 40 turns with a mean diameter of 2½".

"N.H.A." (Epsom) asks (1) How to construct various fixed condensers. (2) Whether he may use a certain set.

(1) As the condensers are of large capacity, we suggest you use the foils $10'' \times 5''$. The dielectric should be special waxed paper, and as each piece of paper is placed in position, wax should be poured over the paper. If a hot iron is passed firmly over it the excess of wax can be removed and the dielectric will be firmly fixed to the foils. Each piece of paper should be examined in front of a strong light for flaws. For 2 mfd. use 221 foils with an overlap $8'' \times 5''$. For 1 mfd. use 111 foils. The 0.5 mfd. condenser should have 57 foils. (2) If you have an experimenter's licence we think there will be no objection to the use of the receiving set referred to. You will, of course, exercise great care in order that no energy may be radiated from the aerial.

"R.J.G." (Leighton Buzzard) asks (1) If reaction is permitted by the P.M.G. (2) What range of wavelengths will the American short wave tuner cover with a single valve or three valves. (3) For a circuit using 1 H.F. rectifying and 1 L.F. valve, with this tuner.

(1) We do not think the P.O. would grant a licence to use the tuner employing the circuit to which you refer. (2) The wavelength range is stated on page 281, June 3rd issue, to be 100 metres to 400 metres, and if you have constructed the set exactly as described, you should tune over this wavelength range. We do not recommend you to add valves to this tuner, and suggest you use a round circuit. A number of three-valve diagrams have recently been given, one of which you should select and connect your tuner up accordingly. (3) A circuit which meets your requirements is given on page 883, September 30th issue. We

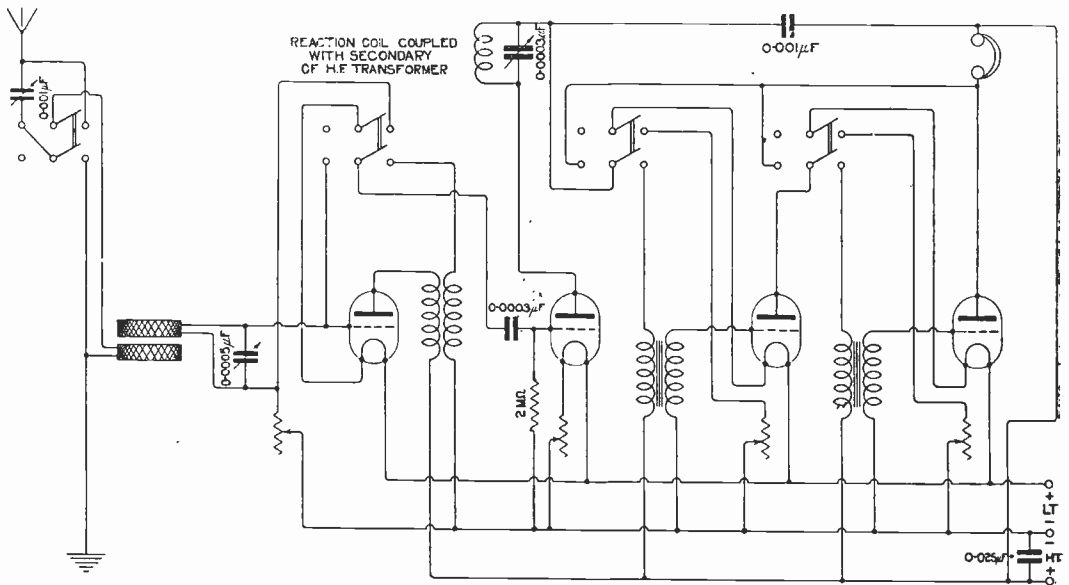

Fig. 4.

"D.D." (Ipswich) asks (1) For a diagram of a four-valve circuit showing how switches are connected. (2) For particulars of the transformers.

(1) See Fig. 4. (2) See recent replies.

"HANTS" (Hants) asks (1) If his circuit is efficient. (2) Whether connections are correct. (3) Value of condenser across primary of H.F. transformers. (4) If his aerial is good.

(1) The arrangement is quite good. Using one filament resistance will not affect results a great deal. (2) The diagram of the back of the panel is correct. (3) The tuning condenser should have a maximum value of 0.0002 mfd. when receiving short wavelengths, but a little larger condenser may be used without loss of efficiency when long waves are being received. (4) You will of course get results, but the results would be much improved by increasing the height of the aerial at the 10'' end. Why not fasten a pole to the wall and so raise the aerial wires.

cannot give precise instructions for building H.F. transformers which will tune from 150 to 3,000 metres. Suitable designs for short wavelengths are given in the issues of September 2nd and September 16th. To increase the wavelength range to 2,600 metres, we suggest you wind an 80-turn basket coil on a $2\frac{1}{2}''$ former with No. 26 S.S.C. wire; you will probably require three in series wound quite close together.

"G.F.P." (Birmingham) asks (1) The specific inductive capacity of transformer oil. (2) Whether this oil would be suitable dielectric for variable condensers. (3) Whether placing coils near the condenser will affect the capacity of the condenser.

(1) The specific inductive capacity of transformer oil is approximately 2.2. (2) This oil would be quite suitable as the dielectric of a variable condenser, but you should take care no moisture is present in the oil. (3) No harmful effects will result, and the interaction will be nil.



MARCONI
GIVES
UNRIVALLED
WIRELESS
SERVICE

The MARCONI INTERNATIONAL
MARINE COMMUNICATION CO. LTD.
MARCONI HOUSE, STRAND, LONDON.

J. BURNS, LTD.

Wangye Works,
Chadwell Heath, Essex.

We are actual manufacturers and can offer special advantages to the trade—send us your enquiries.

CONDENSERS.	retail price
*001 mfd.	16/- ea.
*0005	12/6 ea.
*0003	11/6 ea.
*00005	5/6 ea.
Filament Resistances	3/- ea.
Terminals with high base	1/6 doz.
Contact Studs, with nuts	9d. doz.
Sliders, with springs and studs	9d. ea.
Ebonite Panels, cut to order	3/6 lb.
Ebonite Coil Holders	12/6 ea.

Single Valve Panels

fitted with Variable Condenser, Filament Resistance, Grid Leak and fixed Condenser. Engraved Panel and Rosewood finished Box, ready for use - - -

£4

Vulcanised Fibre and Ebonite Sheets, Rods & Tubes from stock.

WIRELESS

Blocking Condensers	2/-
Grid	2/-
Well-made Filament Switches, for panel mounting, with pointer	4/-
Crystals in Cups, Zincite and Chalcopyrite. per doz.	3/6
All Crystals tested.	
Silk Wire Transformers, Intervalve, 13,000 turns, 5-1 ..	20/-
Ditto Telephone	15/-
Ex-Government A.T.M. Telephone Transformers ..	5/6
Tubes wound with En. wire, shellaced	2/6
Broadcasting coils wound with stranded wire, set of 2, silk wire	3/-
Set of 6 specially wound coils, silk wire, 250 to 3,000 ..	7/6
Well-made switch arms with bush for panel.	2/-
B.T.H. Microphones, with 150w. receivers, with cord ..	5/6
120w. Single Receivers	4/-
Dubilier Condensers in Mahogany cases with terminals for 20,000 Volts	10/-
Ericsson Nickel-plated Microphones	5/-
Valve-holders with screwed legs and nuts	1/-
Ebonite knobs per doz.	4/-
Stranded heavy rubber covered cable, for lead-in, per yd.	6d.
H.T. battery boxes with switches, terminals, etc., with lid	5/-
New and Ex-Army Apparatus in Stock.	
All goods guaranteed.	

C. S. SWAN, 191, Bishopsgate, E.C.2

(Under Brandon's, Tailors), and 65 Windsor Road, Leyton, E.10.
Phone: Bishopsgate 1156.

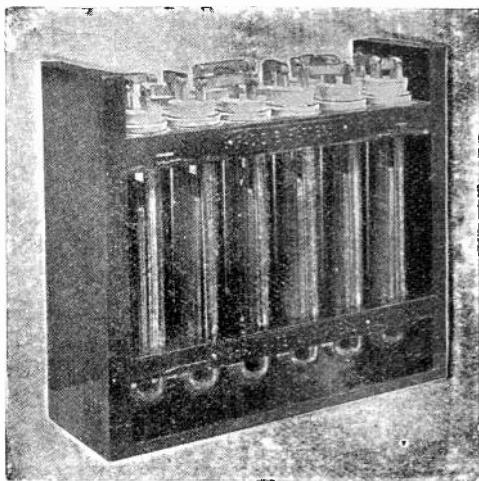

Exide

H.T. BATTERIES

for

VALVE SETS

TYPE B.K. 24v, 28v, or 32v.

Owing to the demand for these batteries all orders will be dealt with in strict rotation. Prices approximately one shilling a volt. Ask for Leaflet 4030.

THE **Chloride** ELECTRICAL STORAGE COMPANY LIMITED

Clifton Junction, Near Manchester
219-229 Shaftesbury Av., London, W.C.2

"W.Z.K." (South Africa) has a spark transmitter, and asks (1) Why tuning is so broad. (2) Whether the set is reasonably efficient. (3) Whether increasing the dimensions of his aerial will ensure greater range.

(1) The reason for the flatness of tuning is the arrangement of the circuit. We suggest you use a coupled circuit, and provide for the degree of coupling to be variable. The coupling required is small. (2) The above alteration will increase the efficiency of the transmitter. (3) The proposed alteration in the dimensions of the aerial will improve the range, but you should also pay a good deal of attention to providing a really good earth.

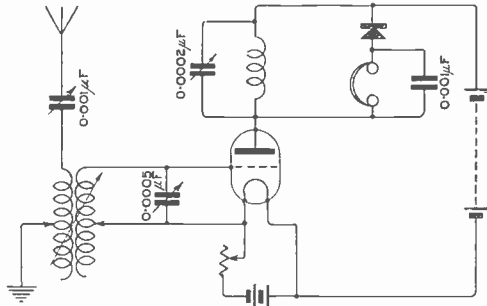

Fig. 5.

"MOULIN" (Kent) asks for a circuit showing the connections of a crystal and valve.

Fig. 6 shows the connections of a crystal with valve connected as note magnifier, and Fig. 5 shows the valve connected as a H.F. amplifier with the crystal as rectifier. The latter arrangement will probably give you louder signals.

"W.J.B." (Treharris) asks (1) How to modify his set in order that he may receive short wavelengths.

We suggest you leave the tuner of the set unaltered, and connect special coils for short wavelength reception. The primary coil may be of No. 22 D.C.C. wound on a former 3" diameter and 4" long, with about 8 tapings. The secondary coil could consist of a coil of No. 26 D.C.C. on former 2½" diameter and 4" long. The 0.00045 mfd. variable condenser should be used for tuning the secondary coil, and the aerial tuning condenser may have a maximum value of 0.001 mfd.

"W.A.M." (Aberdeenshire) asks for criticism of his set.

(1) The diagram is correct except that the H.T. supply for the 2nd and 3rd valves is fed through the primary circuit of the telephone transformer. The arrangement for the use of valves is quite satisfactory since you wish to use a loud speaker, but if you should find that the signals are weak, add another H.F. connected valve. (2) The station referred to transmitted with increased power about the time mentioned in your letter. (3) The tuning coils and condensers are satisfactory, but you will probably notice an improvement in the signal strength if the A.T.C. and A.T.I. were joined in series when receiving short wavelengths. (4) The choke may consist of 3,000 turns of No. 38 S.S.C. wire, ½" diameter and 3" long.

"H.L." (Stamford Hill).—(1) The addition of a tuning condenser (29 plate is suitable) will make tuning easier and will also permit of more selective tuning. (2) The range will be approximately doubled.

"R.B.W." (Gillingham) asks (1) and (2) Size and number of plates required for a condenser of 0.0005 mfd: maximum capacity. (3) The weight and size of wire to use in the construction of the inductance used in the Armstrong regenerative circuit. (4) Which is wound first—the primary or secondary winding.

(1) and (2) If the moving plates are of No. 20 S.W.G. and 2½" in diameter, and the spacing washers are ⅜" thick, 10 fixed and 11 moving will be suitable. (3) Details of the construction of a super-regenerative receiver are given in the issues of October 21st and 28th. (4) The primary winding should be wound on first; then two or three layers of paper, and finally the secondary winding.

"INTERESTED" (Eastbourne) asks (1) For criticism of his receiver. (2) The advantage in using a three-coil holder instead of a two-coil holder. (3) How to increase the range of his tuning coils. (4) Cause of howling.

(1) and (4) When receiving on short wavelengths it is better to connect the A.T.C. and A.T.I. in series. The reaction coil is coupled directly with the A.T.I. When this method of reaction is used, and the set oscillates, you may be sure energy

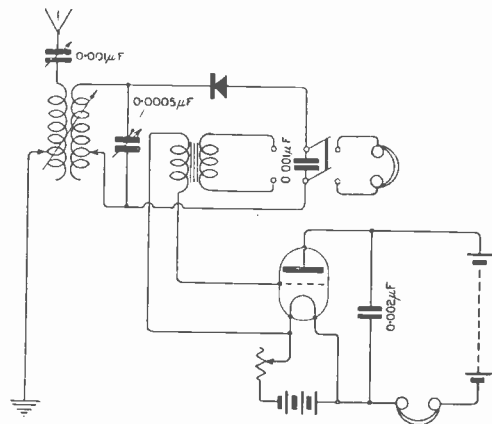

Fig. 6.

is being radiated and interference is caused to your neighbours who are receiving. The cause of the howling is due to the reaction, and you should reduce the size of the reaction coil, or better still, use reaction in any of the ways described in recent issues, so that energy is not transferred to the aerial circuit. (2) The advantage of using a three-coil holder lies in the use of one coil as the A.T.I., the fixed coil as the C.C.I., and the third coil as the reaction coil. Selective tuning and a voltage step up from the aerial to the closed circuit is possible. (3) We suggest you wind a number of basket coils, each coil having 60 turns, and join them in series, the connections of the coils being brought to a switch. The coils should be spaced with ⅛" distance pieces to reduce the self-capacity.

"FLUFFY" (London, W.6.) asks whether certain condensers in his possession are suitable for use in the receiver described on page 281, June 3rd issue.

The condenser values are not suitable, and we suggest you use a condenser with the value given in the article to which you refer. The aerial and earth connections are made to the terminals marked "aerial" and "earth." Additional telephones are connected across the telephones in use, that is, the additional telephones are connected to the terminals to which the telephones which you are now using are joined.

"S.E.D." (Rotherham) asks for particulars of a frame aerial suitable for general purposes.

We suggest you use a frame 5 ft. square with 20 turns, spaced $\frac{1}{4}$ in. Tappings should be taken off to a switch, and the frame aerial should be tuned with a variable condenser.

"H.W.M." (Huddersfield).—The proposed circuit submitted is not quite correct. The filament grid circuit of the first valve should include the whole of the aerial tuning inductance, as shown in Fig. 7. The coil A may consist of a winding of No. 30 D.S.C. wire wound on a former 3" diameter and 5" long. The winding should be tapped at about 15 points.

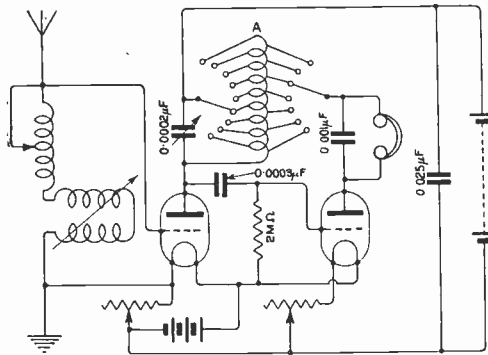

Fig. 7.

"D.A." (Hampton) asks for criticism of circuit.

The proposed circuit is quite suitable except a fixed condenser of 0.001 mfd. should be connected across the telephones. We suggest you couple the reaction coil to the secondary of the H.F. transformer, as described in the issue of September 30th.

"N.D." (Cheshire) asks for criticism of circuit.

The proposed arrangement is quite correct, and the switching arrangements will be quite suitable. If however, you prefer switching of the valve filaments when the valve circuit is cut out, we suggest you see the circuit given on page 883, September 30th issue. The condensers have values as follows:—(1) A.T.C., 0.001 mfd. maximum. (2) C.C.C., 0.0005 mfd. maximum. (3) Grid condenser, 0.0003 mfd. fixed. (4) By-pass condenser, 0.001 mfd. fixed. (5) By-pass condenser, 0.001 mfd. fixed. The circuit would probably be permitted if you have an experimental licence. I.T. should be 6 volts and H.T. 60 volts.

"J.J.T." (Birmingham) asks (1) and (2) The number of turns to wind for reaction coil and secondary coil. (3) The specific inductive capacity of celluloid.

(1) and (2) The reaction coil should be 50 turns wound on the 2" former, and the secondary coil should be 70 turns. It is necessary to tune the aerial and closed circuits, and it will therefore be necessary to change the secondary coil when the aerial coil is charged. (3) The specific inductance capacity of celluloid is from 7 to 10.

"B.M." (Mansfield).—(1) and (2) Lists of commercial transmitting stations and amateur transmitters appear regularly in the journal, and a copy may be obtained from the publishers, The Wireless Press, Ltd., 12-13, Henrietta Street, London. (3) You should receive the Hague Concerts very well.

"R.M.R." (Hants) asks questions about his circuit.

The circuit resembles the Armstrong super-regenerative circuit, but we suggest you work in either of the Armstrong circuits which have been published in this journal. The location, as well as the values of the components, largely determines the behaviour of the receiver, and unless you are very well acquainted with the principles of a circuit of this kind, we think you will be well advised to follow the constructional articles of October 21st and 28th exactly.

"W.D.J." (Liverpool).—We would refer you to the constructional articles which appeared in the issues of October 21st and 28th.

"E.W.B." (Dundee) asks (1) Whether the Armstrong super-regenerative set will receive broadcasting from Glasgow and Aberdeen. (2) Are various coils coupled. (3) What are the dimensions of an iron choke to have 1 henry of inductance. (4) Whether a loop-aerial is satisfactory.

(1) The set referred to will receive broadcasting, but it should be remembered no sets which cause oscillations to be produced in the aerial circuit are permitted to be used for broadcast reception. (2) The coupling of the various coils is a very important matter which requires close attention. It is better to follow out precisely the instructions for building. (3) The iron core choke could be an intervalve transformer, or you could wind an iron wire core $\frac{1}{2}$ " diameter and 2" long with 5,000 turns of No. 38 S.S.C. (4) The Armstrong super-regenerative receiver should always be used in conjunction with a loop aerial, otherwise interference will be caused to neighbouring receiving stations. The P.O. do not authorise the use of an Armstrong circuit or broadcast wavelength, even when connected to a small frame aerial.

SHARE MARKET REPORT

Prices as we go to press on December 8th, are:—

Marconi Ordinary	£2 2 6
,, Preference	2 0 0
,, Inter. Marine	1 6 0
,, Canadian	9 5½

Radio Corporation of America:—

Ordinary	16 0
Preference	13 0

ORA

The Valve for perfect reception

For receiving vocal and instrumental items you must have Mullard "ORA" Valves to get the best results.

Oscillates—Rectifies—Amplifies
Specially recommended where good detection and amplification are required.

15/- each

IMPORTANT NOTICE.

The great demand for Mullard "ORA" valves and other accessories has compelled us to open much larger works.

The "ORA" Valve requires about 3·8 volts on the filament and 30 volts or over between the anode and filament for efficient results.

The MULLARD "R" Valve is now reduced in price from 22/6 to 17/6.

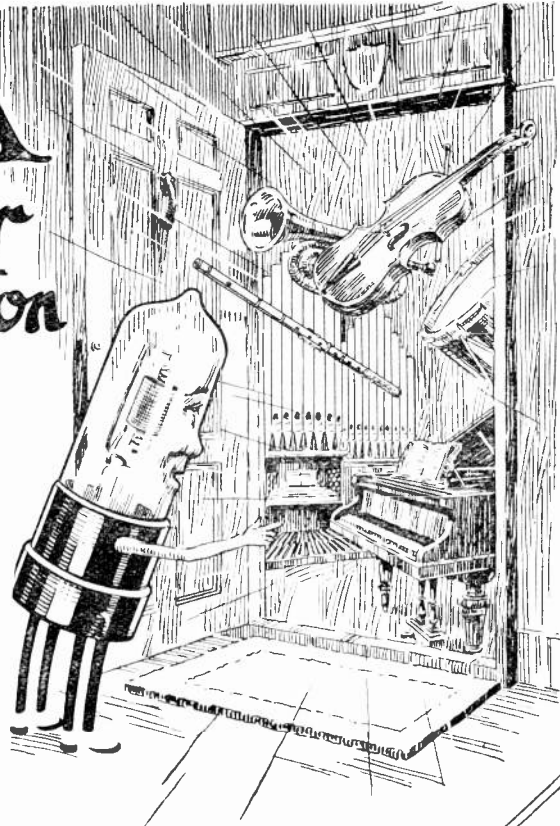

Mullard Radio Valve Co., Ltd

45, Nightingale Lane, Balham, S.W.12.

Contractors to H.M. Admiralty,
War Office, Royal Air Force &
Post Office.

Telephone: Codes: Telegrams:
Battersea ABC (5th Ed.) "Radiovalve,"
1068. Bentley's Hammer Lond.



Name and Address
To the
MULLARD RADIO
Valve Co., Ltd.
45, Nightingale Lane,
Balham
S.W.12.

Please send me post free:

- Quantity
- Description
- Telephone Head Sets
- "ORA" Valves
- Grid A Resistances
- Anode A or B Resistances
- Combined Resistances 0003 mid
- Valve Bases with Condenser
- Valve Sockets
- Terminal Clips
- Name of usual Wireless dealer:

Price	
Type A 21/-	
Type B 25/-	
15/- each	
" " " "	
" " " "	
2/6	
7/6	
5/-	
1/3	
9d. per pair	

I enclose (Cheque,
Money Order, P.O.) Value

to cover the
cost.

**SEND THIS
TO-DAY.**

"BRITWIRE" ACCESSORIES

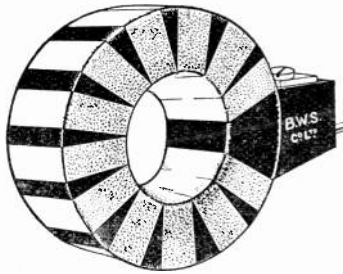

"BRITWIRE" "Sunray" Coils

A new method of winding is incorporated in our "Sunray" Coils giving greatly increased efficiency.

PRICE - - - from 4/6 each

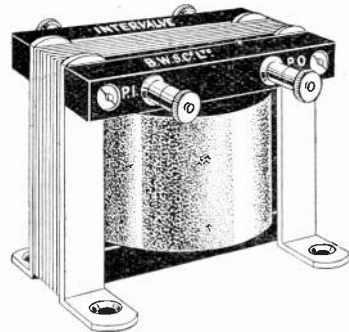

"BRITWIRE" Transformer

A new transformer which has undergone severe tests. The windings are silk insulated and every one passes a test of 1,000 volts which is applied across the windings and the frame.

PRICE - - - 24/- each.
Every one guaranteed by us.



"BRITWIRE" Grid Leaks.

Any resistance.

PRICE - 2/- each
(with clips).

"BRITWIRE" Grid Condensers.

Any capacity.

PRICE - 2/- each.

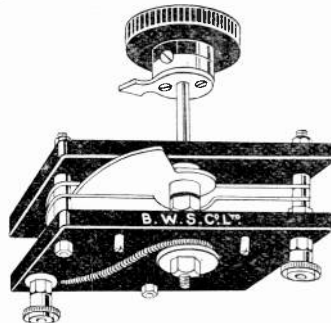

"BRITWIRE" Vernier Condenser.

An absolute necessity for fine adjustment in telephony reception.

PRICE - - - 6/- each.



"BRITWIRE" Aerial Insulators.

Light weight and high insulation resistance.

PRICE - 8d. each
Per Doz. - - 7/6.

LONDON SHOWROOMS.

Our new Showrooms are well situated, excellently appointed and carry a full stock of all "BRITWIRE" manufactures.
Demonstrations Daily. 64, FRITH ST. (Off Shaftesbury Avenue, W.1)

BRITISH WIRELESS SUPPLY Co., Ltd.

HEAD OFFICE: 6, Blenheim Terrace, LEEDS. Telephone: 26926.

And at—18, Eldon Square, Newcastle.
Telephone—Newcastle-on-Tyne 360 City.

33, High Street, Southampton.
Telephone—Southampton 403.

11, Church Street, West Hartlepool.
Telephone—West Hartlepool 373.

8, Corporation Street, Belfast.

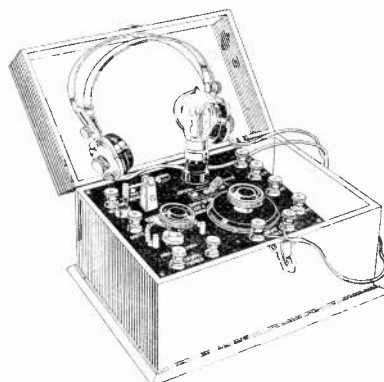
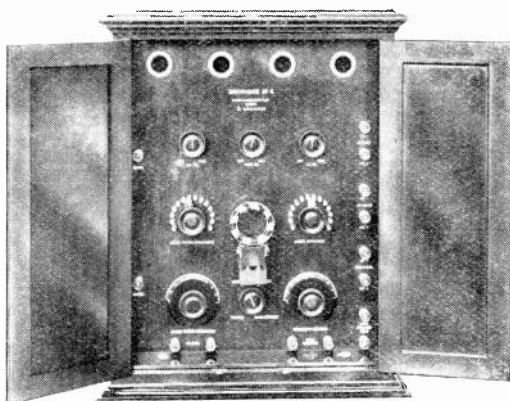

“BRITPHONE” No. 4

Cabinet Measurements, 20½” × 16½” × 9½”. Range covers 200-25,000 metres wavelength.

An excellent Four-valve Broadcast Receiver in polished mahogany cabinet, with folding panelled doors fully in keeping with the general appearance of the instrument. The receiving panel is of Radion Mahoganite.

The Four Valves include 1 H.F., 1 Rect., and 2 L.F. Steps. The last valve by means of a switch acts as either an ordinary magnifier or a power valve for use with any loud speaker. The high tension voltage on this valve can be anything up to 400 volts, thereby obtaining tremendous increase in volume of sound; this is extremely suitable for entertainments in large halls or out in the open. Price complete with all accessories, including four valves and coils up to 4,000 metres, **Forty Guineas.**

A Loud Speaker can be chosen from the large selection we have in stock. Prices from **£2 7s. 6d.**

All “Britphone” Apparatus is approved by the Postmaster-General, and is manufactured under Marconi Patents.

“BRITPHONE” No. 2

The “Britphone” No. 2 can be used simply as a Crystal Receiver, or as a combination of crystal and valve. The addition of the valve is obtained by a special switching device. This set gives extremely clear reception of music, speech and Morse code.

It is contained in solid mahogany case of excellent workmanship and finish. Eminently suitable for Broadcast concerts.

The price includes coils up to 2,000 metres, aerial wire, insulators, headphones, valve accumulators (4 volt 60 amp.), H.T. Battery (60 volts), and also all royalties of the British Broadcast Company.

£13 10s.

Range covers 200-2,000 metres wavelength.

LONDON SHOWROOMS.

Our new Showrooms are well situated, excellently appointed and carry a full stock of all “BRITWIRE” manufactures.

Demonstrations Daily. 64, FRITH ST. (Off Shaftesbury Avenue, W.)

BRITISH WIRELESS SUPPLY Co., Ltd.

HEAD OFFICE : 6, Blenheim Terrace, LEEDS. Telephone : 26926.

And at—18, Eldon Square, Newcastle.

Telephone—Newcastle-on-Tyne 360 City.

33, High Street, Southampton.

Telephone—Southampton 403.

11, Church Street, West Hartlepool.

Telephone—West Hartlepool 373.

8, Corporation Street, Belfast.

BRITISH
"TEC"
MAKE

T. E. C.

BRITISH
"TEC"
MAKE

Patent
Spring
Con-
nec-
tions
are
specially
adaptable
for
Wireless
Work.

PATENT

SPRING CONNECTIONS
IN NUMEROUS SIZES & DESIGNS

SIMPLE STRONG CHEAP EFFECTIVE		LARGE STOCKS PROMPT DESPATCH
--	---	---

The EFANDEM CO. LTD
FALLINGS PARK WORKS WOLVERHAMPTON
TELEGRAMS "EFANDEM"
PHONE 1123

Ask for Samples and Illustrated Price List.

Patent
Spring
Con-
nec-
tions
are
specially
adaptable
for
Wireless
Work.

WIRELESS

Component Parts for Wireless a Speciality

:: :: Complete Cabinet Crystal Sets :: ::

:: :: Build Your Set by Degrees :: ::

All Suitable Tools and Materials in Stock

:: Complete Folding Work Benches ::

RICHARD MELHUISS LTD.

Tool, Machine & Hardware Merchants, Electrical Engineers

50, 51 & 84, Fetter Lane, E.C.4

Telephone : 1611 (3 lines) Holborn. Established 1828. Telegrams : "Workfolk, London."

Awards for Excellence of Tools and Machines :

Bronze Medal 1884.

Gold Medal 1890.

Instruments of Quality

AT MODERATE PRICES.

THE policy of the Company is to supply only goods of the highest quality in design, workmanship, finish and performance.

ONE EXAMPLE :

G.P.O. Registered No. 0167.

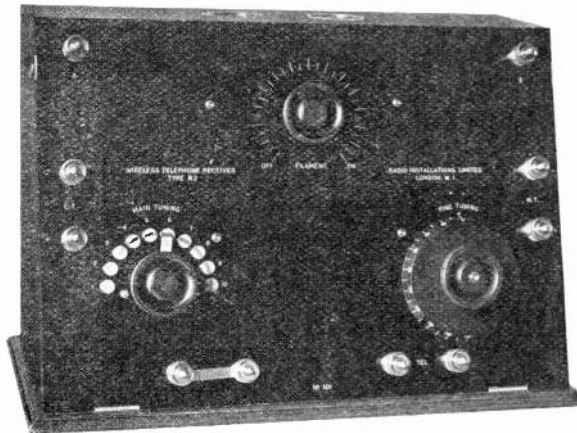

WAVELENGTH
200-3,000
METRES.

SCIENTIFIC
DESIGN.

RANGE
100
MILES.

PERFECT
WORKMAN-
SHIP

Catalogue No. W51. TWO-VALVE RECEIVER, complete with two MULLARD ORA Valves **£16 : 16 : 0**

ACCESSORIES for above, viz.:

1 L.T. Battery, 6 volts, 33 ampere-hours ;
1 Genuine HELLESEN H.T. Battery,
60 volts ; 1 pair STERLING first quality H.R.
Telephones ; 100 ft. Aerial Wire, leading-
in and Aerial Insulators. } **£6 : 6 : 0**

COMPLETE SETS AND PARTS OF ALL DESCRIPTIONS.

Trade Enquiries Invited.

RADIO INSTALLATIONS, LTD.

EMPIRE, HOUSE,

175 PICCADILLY,
LONDON, W.1

Telephone :
Regent 2336.

Telegrams :
Radioinsta, Piccy, London.



*"The Services
use them"*

BACK in 1909 the Admiralty adopted Ericsson Telephones as standard. In 1917 the R.A.F. followed the Senior Service's example. Protracted tests proved Ericsson Phones' immense superiority over long distances. Clarity of speech and total absence of dis-

tortion in telephony placed them in a class by themselves. Telegraphists tell us they get distinct signals when other makes indicate "nothing doing." Light and easy to the head, robust in construction yet delicate in operation, they put the ideal finishing touch on any set-crystal or valve.

Write for fully illustrated descriptive List free.
The BRITISH L. M. ERICSSON MANUFACTURING Co. Ltd.
International Buildings, 67/73, Kingsway, W.C.2

2,000 ohms, pair - 31/-
4,000 ohms, pair - 32/-
(All Resistances in Stock)

Ericsson
Telephones

SKINDERVIKEN BUTTON.
THE SUPERSENSITIVE MICROPHONE.
 World-wide Patents.
 ENGLISH Manufacture.
 For LOUD SPEAKERS, MICRO AMPLIFIERS, ELECTRICAL GRAMOPHONE REPRODUCERS.
 Invaluable as Detectophone, as it can be used in ANY POSITION, i.e., either HORIZONTAL or VERTICAL.



PRICES.
 Type "A"—Carbon Electrodes (eliminating all "frying" noises) each 7/6
 Type "B"—Brass Electrodes 5/-
 Receivers (special Low Resistance) 10/-
 Gramophone Attachments (for Electrical Reproduction) . . . 1/-
BOOKLET (16 Pages fully illustrated) containing much useful information for all interested in Electrical Sound Transmission. **POST FREE 6d.**

Sole Proprietors:
MIKRO, LTD., 274/276, Pentonville Road, London, N.1.
 (Opposite King's Cross (Met.) Railway Station.)

Telephone: City 2372.

A. MUNDAY, Ltd.,
 59, WATLING STREET, E.C. 4.
 (One door Queen Victoria Street. One door Queen Street.)
 4-7, EASTCHEAP, E.C. 3.

AERIAL WIRE, 7/22 copper, 2/9 100 ft.
 CONDENSER VANES, 6d. per dozen.
 CONTACT STUDS, complete with nut, 5d. per dozen.
 IVORINE SCALES, 0-180, 3d. each.
 4,000 ohm PHONES, best make, 20/- per pair.
 Brown's 4,000 ohm " " " 30/- " "

You must have the best Accumulators for Wireless

Low Prices

Send for Complete Lists

The ESSEX Accumulator Co., Ltd.
 499, Grove Green Road, Leytonstone, E.11
 Telephone Wanstead 749

Complete Unassembled Crystal Receiving Sets, Cabinet Type
 With Printed Instructions post free 17/6
 4000 Ohm Extra Sensitive Phones " " 25/6

Low Frequency Intervalve Transformers
 New Design, Highest Efficiency ... post free 21/6
 Or Two at... .. " " 40/6

THE SOUTH WESTERN WIRELESS Manufacturing Company, PENZANCE.

No Waiting. Delivery from Stock



Perry Head Phones 4,000 Ohms 21/- per pair

Specially designed for Wireless Telegraphy. Receivers arranged in series, Aluminium Cases and fitted with extremely light and efficient Head Bands, and Twin Connecting Cords.
Illustrated Wireless Catalogue now ready, post free 3d.

The JEARY Electrical Co., Ltd.
 8, LAMBETH HILL & 97, Queen Victoria St., London. E.C. 4

NORTH - EASTERN SCHOOLS OF WIRELESS TELEGRAPHY
 Established 1911.

18, Eldon Square, Newcastle-on-Tyne
 6, Blenheim Terrace, Leeds
 33, High Street, Southampton

Young men between the ages of 16 and 25 are trained at these Schools in the profession of Wireless Telegraphy and Telephony. All Four Systems are taught, Marconi, Telefunken, Poulsen and Valve. Special terms to partly trained students.
Splendid Openings for Trained Wireless Men.
 Write or call for Illustrated Prospectus.

L.O. HERE IT IS.—M. E. C.



Crystal Receiver complete with everything in polished Cabinet. Royalty paid to B.B.C. Reg. No. 138. Carriage paid from stock. All tested and guaranteed they speak loud and clear.

Price **£3 : 15 : 0** complete.

M.E.C., Crownhill Road, Harlesden, London, N.W.10.
 Willesden 3370

Every Wireless Dealer and Manufacturer should have our Price List of

Strawboard Inductance Tubes
 The envelope is waiting your name and address.
Deliveries from Stock. Wholesale only.

A. EATON LEE & CO.
 4 Little College Street, London, E.C.4
 Tele. Central 4839. (near Cannon Street Station)

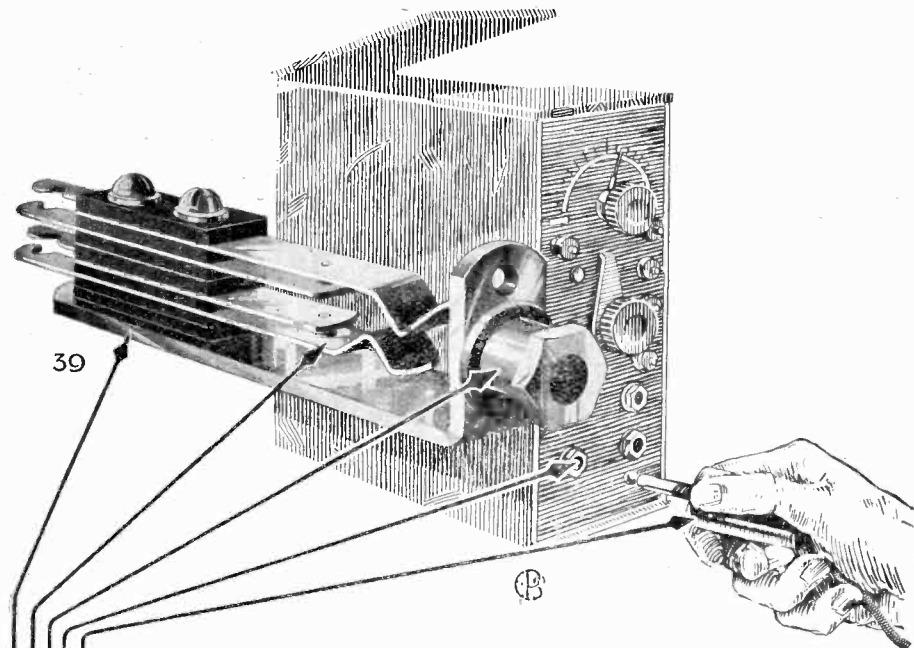

GET THE BEST OUT OF YOUR SET BY USING

THE ELWELL JACK SYSTEM

(a) Any standard telephone plug can be used but preferably the special spiral Elwell plugs which are fitted with self-tightening connection grips.

(b) The Jacks fit neatly on the panel and being heavily nickel plated add considerably to its appearance.

(c) They are easily fixed to any panel up to $\frac{3}{8}$ " thick. No fixing screws are required.

(d) Five types of jacks are available from a simple telephone jack to one controlling telephone, transformer and filament battery.

(e) Insulation tested up to 1000 volts.

Once connected up on the Elwell Jack System your receiving set becomes far more convenient to use both for broadcast reception and for experimental purposes. The following operations become quite automatic:—

1. Filaments switched on.
2. Telephones or loud speaker put across any desired number of valves.
3. Intervalve transformers disconnected at point of insertion so ensuring maximum efficiency.
4. Only the required number of valves light up. The remainder stay out of circuit.
5. Removing Plug completely switches off set. No errors can afterwards be made in connections or switching. Loose contacts and broken leads are permanently prevented. Comparative tests of telephones and loud speakers can be made with ease and accuracy.

Write for descriptive leaflets.

C. F. ELWELL, LTD., *Radio Engineers,*
CRAVEN HOUSE, KINGSWAY, LONDON, W.C.2
 Telephone: REGENT 421.

ELWELL
High Power
Wireless
Stations

Oxford

Cairo

Northolt

Horsea
Island

Eiffel
Tower

Lyons

Nantes

Rome

& others

ELWELL
WIRELESS

The "Autoveyors" 3-ELECTRODE VARIABLE CONDENSER

(British Patent 17703/22)

is the most efficient precision controller of oscillations in radio circuits. It comprises three sections, each consisting of a tier of parallel plates of one-third disc area. The centre section is spindled and knobbed, and permits a variation of capacity over 360 degs. Both side sections are spindled and knobbed and permit Vernier control of extreme precision. Thus, whilst providing all the essentials of the ordinary 2-Electrode Variable Condenser, it affords the added advantage of the coupling of the third electrode, which may be applied in a thousand and one ways.

In **Aerial Circuits** the 3-E.V.C. permits the application of capacity from Zero Series to Maximum Parallel by a single operation. Additional switches are unnecessary, and detuning from Series to Parallel is avoided.

In **Closed Circuits** it provides a precision-controlled static coupling for synchronous super-regeneration or relay radiation choke of unbounded possibilities.

In **Grid Circuits** it permits the employment of regenerative static influence upon the input.

In **A.ode Circuits** it affords definite control of by-pass, stability and regenerative applications.

In **Oscillator Circuits** the 3-E.V.C. ensures precision control of synchronism.

Full particulars from the Sole Patentees:—

AUTOVEYORS, LTD.

Radio Engineers and Contractors

84, Victoria Street, London, S.W.1

Phone: Victoria 309.

Through its efficiency this L.F. Transformer has earned a reputation for itself and is now in constant demand by every class of user—

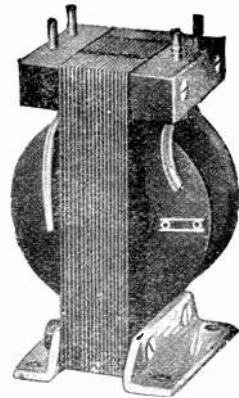

Ask your dealer for
GENTS' "TANGENT"
L.F. TRANSFORMER
AND
GENTS' "DISCOL"
H.F. TRANSFORMER

PRICE 22/6 EACH.

SEND FOR LEAFLETS, FREE.

RADIO DEPT.,

GENT & Co. Ltd. FARADAY WORKS LEICESTER

LONDON: 25, Victoria Street, S.W.1.

N WCASTLE-ON-TYNE: Tangent House, 52, Blackett Street.

16 Pages, handsome cover in three colours, gives you full information and prices on Wireless Receiving Sets complete from £3 10s. to £12 10s. Hear all the concerts, speeches, sermons, news, crop and weather reports, now being broadcasted daily. Costs you nothing after first cost. Easy to install and operate. And hundreds of other Wireless articles.

Write to-day. FREE.

**PERMANENT ONLY
CRYSTAL 7/6
DETECTOR** Post paid

Ready to attach to your set.

Greatest boon ever known to Wireless Experimenters. Always ready, no fiddling or searching for a point. Crystal always active. Largest mail-order firm in Europe. **Important Notice.**—All our apparatus is guaranteed "your money back in full" if not satisfied. Write to-day.

**BRITISH RADIO
SALES CO. LTD**
STEPHENS BUILDING, GRASSHOPPER ST.,
BATHURST, W.C.2, LONDON, W.C.1.

**GENUINE
HELLESEN
DRY BATTERIES**

HIGH TENSION WIRELESS BATTERIES.

SPECIAL TRADE AND WHOLESALE TERMS			
Code word.	Volts.	Details.	Price.
"WIRON"	15	Screw terminals	4/- each
"WIRTO"	15	Strip	4/- "
"WIRIT"	36	2 insulated wander plugs	8/6 "
"WIRIN"	60	2	14/- "

Wander Plugs and Terminals are included in the price of the Battery and are NOT AN EXTRA.

KNOWN THE WORLD OVER AS THE BEST.

ALL LISTS FREE ON APPLICATION.

A. H. HUNT, LTD.
H.A.H. Works, Tunstall Rd., Croydon, Surrey

"RADIO - WAVE" CONCERT RECEIVERS.

TWO-VALVE RECEIVER; BROADCAST RANGE 100 MILES.



PRICE: £16 : 16 : 0 with Valves.

Approved by the P.M.G. for Broadcast Reception.

THE "Radio-Wave One-Valve Receiver (Price : £10 : 10 : 0) meets the needs of those living within 50 miles of a Broadcasting Station. For those living at greater distances there are the Radio-Wave 2, 3, 4 and 5 Valve Sets. These are described in our catalogue which contains over 40 illustrations of wireless apparatus actually made in our works, sent free.

THE MEDICAL SUPPLY ASSOCIATION, LTD.

167/185, Gray's Inn Road, London, W.C.1.

Works : LONDON & SHEFFIELD.

Telephone : MUSEUM 7212 Ext. 3.

"For they are jolly good Fellows"

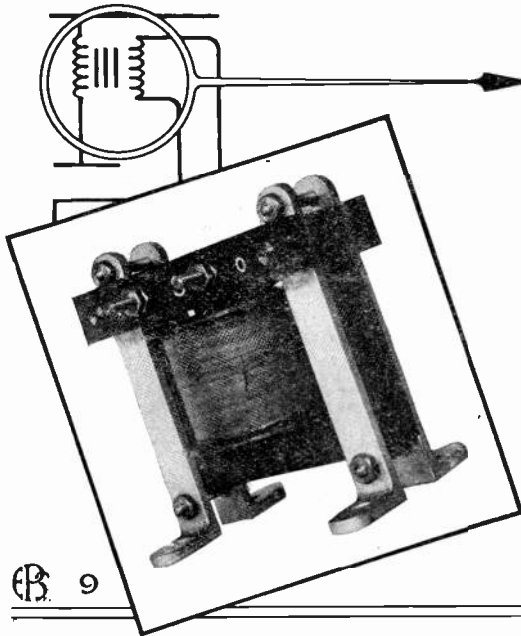

INTERVALVE TRANSFORMERS

Use Fellows Intervalve Transformers, and secure maximum amplification with freedom from distortion and extraneous noises.

British made throughout and guaranteed.

PRICE **22/6** (POSTAGE **6d.**)

FELLOWS MAGNETO CO., LTD.
LONDON, N.W.10.

Telephone :
Willesden 1560-1.

Telegrams :
Quixmag, Phoea, London

B.T.H. Broadcasting Crystal Receivers

APPROVED BY G.P.O.

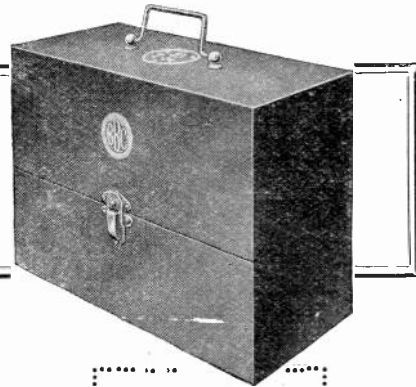

provide perfect reception within any radius up to 30 miles from a Broadcasting Station. This claim has been verified by actual experience on Broadcasting from London, Manchester and Birmingham.

Superlative Design Workmanship and Finish

Supplied ready for immediate use, with set of B.T.H. Patent Head Telephones and complete Aerial Equipment. **Price £7 15s.**

Extra head telephones can be used with this receiver if desired. **Price per set, 30/-.**

*Enclosed
Alternative
Crystals*

*Smooth
Tuning
No Moving
Contacts*

*No Batteries
Required*

An Ideal Christmas Present

Contractors should apply for trade terms immediately. Deliveries from Stock.

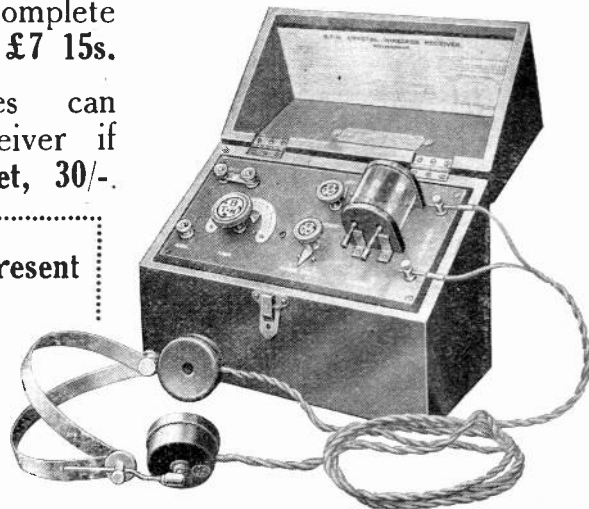

The British Thomson-Houston Co., Ltd.

Electrical Engineers
Head Office & Works



and Manufacturers
:: :: Rugby, England

IMPORTANT NOTICE To the Public and Trade

Our policy has always been one of individual attention and promptness of delivery. Owing to the enormous increase in business we are now greatly extending our organisation.

This is to give notice of the following Changes of Address:

Head Office and Wholesale Showrooms

are now located at
HASTINGS HOUSE, NORFOLK STREET, STRAND, LONDON, W.C.2

to which address *all correspondence* should be sent.

Demonstration and Retail Showrooms

are now located at
179, STRAND (Corner of Norfolk Street), LONDON, W.C.2

ALL GOODS are to be sent to our **WAREHOUSE AND WORKS,**
Providence Place, West End Lane, Kilburn, London, N.W.6

LESLIE McMICHAEL Ltd.

EXAMPLES OF VALUE

ENGRAVED CONDENSER DIALS, POLISHED, 1/6, with knob, 2/3.
CRYSTAL DETECTOR. Complete with crystal, terminals, latest adjusting movement, on ebonite base, 3/3 each.
SELECTED CRYSTALS, ASSORTED, 2/6 per dozen.
SAXON IMPROVED FILAMENT RESISTANCE, 3/3 each.
ALUMINIUM CONDENSER VANES, BEST QUALITY, 8d. per dozen.
POLISHED KNOBS, 1½" diameter, 4½d., tapped and bushed, 6d. each.
SAXON LOW FREQUENCY TRANSFORMER. One of the best and most efficient transformers obtainable, 18/6 each.
Ebonite Rod and Tube, see November 25th issue.
Polished instrument cases, see December 2nd issue.
SAXON COILS AND COIL HOLDERS. See December 9th issue.
BEGINNER'S GUIDE TO WIRELESS. See December 9th issue.

EBONITE CIRCULAR DISCS

BEST VALUE OBTAINABLE.

Diameter	1"	1½"	2"	2½"	3"	3½"	4"
1/16" thick	1d.	1½d.	2d.	2½d.	3d.	3½d.	4d.
¼"	1½d.	2d.	2½d.	3d.	4d.	5d.	6d.
3/16"	2d.	3d.	3½d.	5d.	6d.	7d.	8d.
½"	2½d.	3½d.	4½d.	6d.	7d.	8½d.	11d.
¾"	3d.	4d.	5d.	7d.	9d.	11d.	—
1"	3½d.	4½d.	6d.	8½d.	11d.	—	—

SAXON RADIO CO. Actual Manufacturers of
Wireless Apparatus.
Henry St. Works, South Shore, BLACKPOOL
32 page Catalogue, 3d. post free.

"OOJAH" BASKET INDUCTANCES



We have pleasure in announcing that owing to the reduction in the price of wire and greatly increased output we are able to lower the price of OOJAH BASKET INDUCTANCES to

PER **5/-** SET

Postage 4d.

LIBERAL DISCOUNT TO FACTORS.

All "OOJAH" Inductances are wrapped in a transparent covering and sealed with the Registered Trade Mark "OOJAH."

The Seal is a guarantee of quality.
None are genuine without.

"OOJAH" Basket and Slab Inductances are being extensively copied, as most good things are, and purchasers are advised to not only specify "OOJAH" Brand in their order, but to see that the seal is intact.

GREENSLADE & BROWN
LANSDOWNE ROAD, CLAPHAM, S.W.9

Telephone—BRIXTON 639 & 3251.

LESLIE M^c MICHAEL LTD.

BROADCAST RECEIVING SETS

The following are a few of the many Receiving Sets which we manufacture for the use of those holding either Broadcast or Experimental licences :-

RADIOMAC CRYSTAL, MARK III. The range of this set is about 50 miles, wavelength 50-700 metres; covering the entire broadcasting and range used by shipping. Brand new in mahogany box complete, with pair of 4,000 ohm telephones.
 Price, including Broadcast Fee. **£10 10s.**

RADIOMAC 2B. A two-valve set in polished mahogany box, range covers all broadcasting. The set has provision made for "plug-in" coils, in order to cover all wavelengths.
 Price of set **£9 9s.**

Accessories to make complete receiving station, **£5 2s.**
 Licence Fee payable through us to the British Broadcasting Co. **£1 15s.**
 Total cost of complete station **£16 6s.**
 Carriage paid.

RADIOMAC 3B. A three-valve set of greater efficiency. Price **£12 12s.**
 Accessories suitable for same **£5 19s. 6d.**
 Licence Fee payable through us to the British Broadcasting Co. **£2 5s.**
 Total cost of complete station **£20 16s. 6d.**
 Carriage paid.

All our valve apparatus is manufactured under Marconi Licence.

We guarantee all the above sets which were originally purchased by H.M. Government. They are new and in perfect condition.

London Showrooms : 179, STRAND (Corner of Norfolk Street), W.C.2
Head Office, to which all correspondence should be sent :
HASTINGS HOUSE, NORFOLK STREET, STRAND, LONDON, W.C.2

Extracts from our Catalogue.



LOUD SPEAKER



HEAD PHONES

(3s. POST FREE)	
<p>Aerial Insulators, Shell Type, 2 1/2" x 2 1/2" approx., best finish each 1/3</p> <p>Aerial Insulators, Reel Type, 2 1/2" dia. approx. each 3d.</p> <p>Aerial Insulators, Strainer, 2 1/2" x 1 1/2" approx. each 8d.</p> <p>Aerial Leading in Tubes, sturdy ebonite, 6" overall, each 1/8, 12" overall each 2/-</p> <p>Aerial Pulleys, small 2 1/2" each 1/-</p> <p>Brass Rod, Screwed, 4 B.A. in 12" lengths each 4d.</p> <p style="padding-left: 20px;">5 B.A. in 12" lengths each 3 1/2d.</p> <p>Brass Washers, 2, 3, 4 or 5 B.A. doz. 2d.</p> <p>Brass Nuts, 2, 3, 4 or 5 B.A. doz. 4d.</p> <p>Batteries, Flash Lamp, 5/- doz. Terminals to fit contacts of Flash Lamp doz. 2/-</p> <p>Condenser Vanes, 2 1/2" diam., in .022" hard drawn aluminium doz. 9d.</p> <p>Condenser Vanes, other sizes see list.</p> <p>Condenser Spacing Washers. Accurate, large 6d. doz., small doz. 2/-</p> <p>Condensers, fixed, .0001 to .0005 each 2/6</p> <p style="padding-left: 20px;">.001 to .002 each 2/3</p> <p style="padding-left: 20px;">.003 to .004 each 3d.</p> <p>Crystal Cups (with screw to fix crystal) each 3d.</p> <p>Contact Studs (superior finish, 1/4" x 1/4", with nut and washer) doz. 1/-</p>	<p>Aerial Pulleys, large 5 1/2" with tackle, hook and bucket. each 2/6</p> <p>Accumulators (Oldham's Special Process)</p> <p style="padding-left: 20px;">4 volt 40 amp. I.C. each 20/-</p> <p style="padding-left: 20px;">4 volt 80 amp. I.C. each 22/6</p> <p style="padding-left: 20px;">6 volt 80 amp. I.C. each 27/6</p> <p style="padding-left: 20px;">8 volt 80 amp. I.C. each 32/6</p> <p>Brass Rod, screwed, 2 B.A. in 12" lengths each 5d.</p> <p style="padding-left: 20px;">3 B.A. in 12" lengths each 4 1/2d.</p> <p>Copper Foil Sheets (uniform thickness, 12" x 3") each 3d.</p> <p>Core Wire, soft iron in straight lengths lb. 2/4</p> <p>Coil Mounting Plugs, with screw connections each 1/6</p> <p>3 Coil Holders for panel mounting each 12/6</p> <p>Ebonite Engraved Dials each 1/6</p> <p>Ebonite Sheet, best quality, light not loaded lb. 5/-</p> <p>Filament Rheostats for Panel Mounting, the best offered each 3/6</p> <p>Grid Leaks and Condensers (tested with proper instruments) each 5/6</p> <p>Instrument Wires. Hundreds of miles in stock, competitive prices.</p> <p>Insulated Sleeving, 1 1/2 m.m. yard 6d.</p> <p>Inductance Sliders, with spring and plunger each 6d.</p> <p>Inductance Sliders Rod, in 13" lengths each 4d.</p> <p>Ivory Scales, engraved, not printed each 10d.</p> <p style="text-align: right; font-size: small;">Please include ample postage, balance will be returned.</p>

Wholesale Distributing Agents for Scotland :-
J. GORSTON SINCLAIR & CO., 47, Waterloo Street, Glasgow.



(Dept. W.) 24, LONDON ROAD, MANCHESTER.
 Works : Berry Street.
 Phone : Central 4209. Grams : "Pladuram, Manchester."

Retail Agents for Bradford :-
THE GRAMOPHONE STORES, Bowling Old Lane.



Series No. 4

Makers of over Half
the World's Telephones.

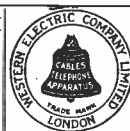

Western Electric

LOW FREQUENCY AMPLIFIER

Supplied in either one or two stages complete
in a compact case of polished mahogany.

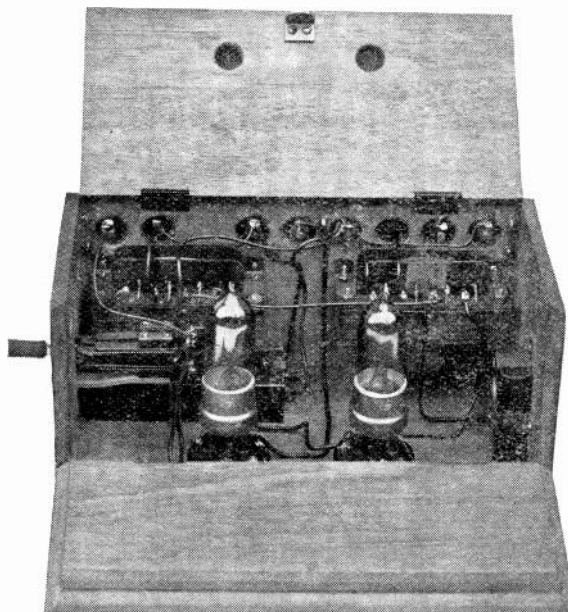

The stages of amplification are controlled by a key fitted at one end of the case. The filament can be seen and inspected through a window in the case and ventilation discs control the temperature of the compartment. Simply designed, this Western Electric Low Frequency Amplifier can be depended upon for unflinching efficiency.

Western Electric Company Limited.

62, Finsbury Pavement, London, E.C.2
Telephone—London Wall 7608

WORKS:—

North Woolwich, London, E.16
Telephone—East 3840 (10 lines)

Also at BEXLEYHEATH, KENT, and NEW SOUTHGATE, N.11

Birmingham—Grenville Buildings, 12, Cherry St.
Leeds—Standard Buildings, City Square.
Cardiff—Motor House Chambers, 1, Wood St.

Manchester—Northern Assurance Buildings.
Newcastle—20 Saville Row.
Glasgow—49, West Campbell Street.



Components

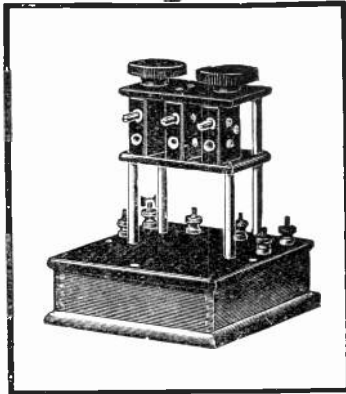

*Every Article
made by
Auckland's
is in a Class
by Itself.*

- Series Parallel Switches 4/6
- Table Coil Holder 3 way 18/-
- " " " 2 " 15/-
- Fil. Resistances 3/9
- Interval Transformers 20/-
- Igranic (Auckland)
Coils from 5/-

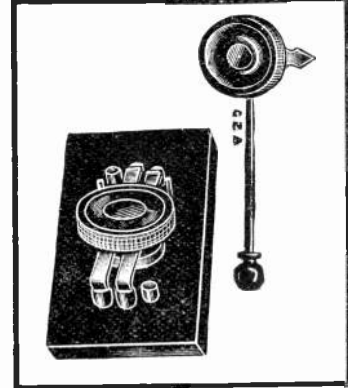

CATALOGUE FREE

- Telephone Transformers 13/6
- " " Mtd. 17/6
- Extended Knobs and
Pointer 1/6
- Condenser Dials and
Knob 3/9
- Coil Plugs 1/6
- Fibre Strip 4' 6" 1/-
- Uni Wave Slabs—Set . . 12/6
- Grid Leak and Con-
denser 4/6
- Pin Type H.F. Trans-
former for Broadcast 5/-

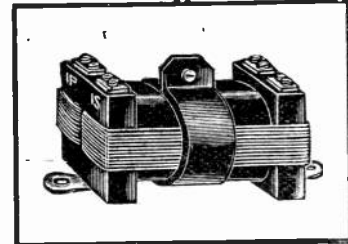

We carry stocks of all makes of H.T. Batteries, Phones and Valves, and supply from stock.

Why not make use of our World Wide Service? It will pay you, especially if you say

*“Auckland
Products”*

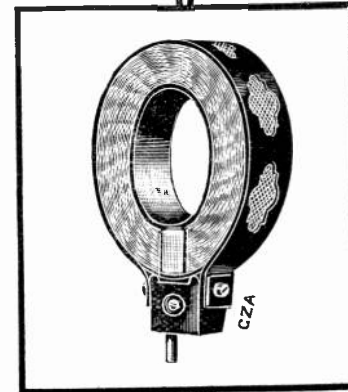
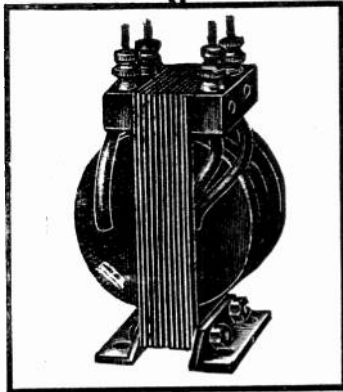

G. Z. AUCKLAND & SON,
Factories—ISLINGTON, N.

WIRELESS INSTRUMENT MAKERS

LONDON OFFICES:
395, St. John Street, E.C.1
'Phone 3178 CLERKENWELL



Introducing the new

CLEAR SPEAKER Peto-pan

—a real Clear Speaker

Purity of sound has been the ideal aimed for in the design of this Loud Speaker. Too many Loud Speakers give an immense volume of sound but only at the expense of its quality. The Peto-pan is not the loudest, but it is certainly the clearest of them all.

If you want to fill a hall, don't buy a Peto-pan, but if you want to sit by your fireside and enjoy a concert, hearing every word and every note faithfully reproduced, this is certainly the Loud Speaker you need.

Not a telephone earpiece on the end of a horn, but a Reproducer specially designed for its job and fitted to a horn complying with the requirements of the laws of acoustics—in short, *the Ideal Loud Speaker.*

Three special features :

1. The diameter of the reproducer is almost twice the size of the ordinary 'phone. This gives extreme sensitivity and volume without distortion.
2. An external lever permits the pitch of the note to be easily adjusted.
3. The long straight horn—free from curves or bends to deflect sound—gives a full clear sound free from any disagreeable metallic ring.

4000 ohms only

50/-

Broadcasting Co.'s
Royalty 3/- extra

Offices and Showrooms :

FEATHERSTONE HOUSE,
64 HIGH HOLBORN, W.C.1



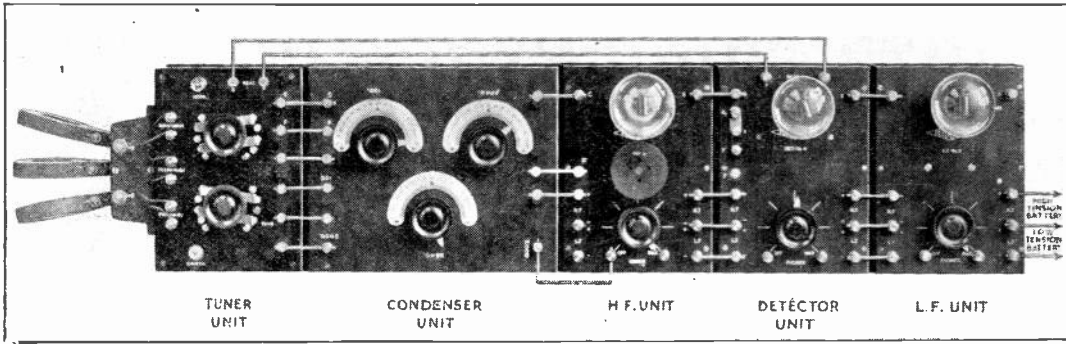

Treat yourself to a sensible Xmas Gift

—one all the family can enjoy 365 days in the year



Reproduction of illustrated instructions supplied with No. 4 (Detector) Unit. Note how every point is fully explained.

All Peto Scott Standardised Radio Units sold under licence from the Marconi Co., Ltd.

If you can use a screwdriver and a pair of pliers you can easily build up a Peto Scott standardised Radio Unit.

Look at the Three-Valve Set illustrated above. Isn't it an instrument you would be proud to own? Such a set supplied ready for home construction, complete with full instructions, would cost you but a fraction of the price you would have to pay for a ready-built 3-valve. Work out its cost from the table of prices given below.

Why not treat yourself to a Radio Set—there's just time, if you order right away, for you to have it working in time for the Christmas holidays.

Our Booklet "Radio" shows how easy it is for a novice, with absolutely no previous experience, to build up a Multi-Valve Set of high efficiency. Fully illustrated—6d. post free. 32-Page Catalogue free with every Booklet.

PRICE LIST OF SETS OF PARTS

Unit.	Description.	Price.	Cabinet.
1	Condenser Unit.	42/-	7/-
2	Tuner Unit (without coils)	27/6	3/6
3	H.F. Amplifying Unit.	18/6	3/6
4	Detector Unit	17/6	3/6
5	L.F. Amplifying Unit	33/6	3/6

Postage 9d. per unit extra, but paid on all orders of £2 and over

OFFICES & SHOWROOMS :

**Featherstone House,
64, HIGH HOLBORN, W.C.1**

No. 4 (Detector) Unit

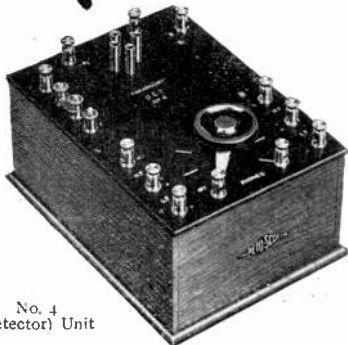

MARSHALL AD.

Charging Radio Batteries at Home

If you use valves in your radio receiver you use a storage battery.

If you use a storage battery it must be charged.

Charge your storage battery at home with a Tungar Battery Charger.

Without taking the battery out of the house—in fact without moving it at all—you can charge it easily and quickly at a minimum of expense and trouble.

Isn't this much better than taking the battery to an electrician, leaving it a day or two, paying a few shillings and then carrying it back again?

**B
T-H** **Tungar**
BATTERY CHARGER

for use on A.C. Circuits.

The Tungar is a small, compact rectifier which connects to any lamp-holder or wall plug on an alternating current lighting circuit and requires no attention while operating. Its first cost is not high and it can be used by anyone without the slightest risk of injuring the battery.

Send for booklet No. L228.

The British Thomson-Houston Co. Ltd
MAZDA HOUSE, 77 UPPER THAMES STREET, LONDON, E.C. 4
BRANCHES IN ALL LARGE TOWNS.

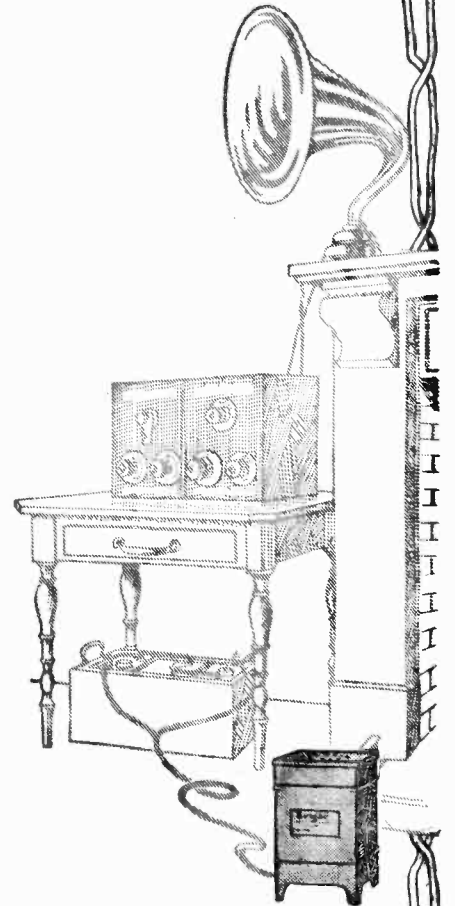

2 amp Tungar connected to Radio Battery and to wall plug by the fireplace.

WIRELESS TRAINING COLLEGES, LTD. MARKET BUILDINGS, CARDIFF, & ALBERT RD., BOURNEMOUTH

The above Colleges are amongst the Most Successful in existence. We are NOT A BOOM FIRM but have 10 years reputation for not only Passing our students, but what is most vital, **GETTING THEM BERTHS WHEN QUALIFIED.** This past three months we have placed over 30 Youths in Permanent Berths. We instruct on Valves, and 1½ kW. Marconi Sets. We have NOT a Qualified Student out of berth to-day. Also Wholesale Distributing Superintendent for Messrs. Stuart Wireless Telephone Co., the Valve Set which NEVER FAILS YOU. *Agents Wanted. Wholesale Only.*

Principal : HON. LT. COMMANDER J. R. SCHOFIELD, M.B.E., R.N.V.R. (C).

P.S.—Students taken individually, so can enter any day suitable.

BROADCASTING

You cannot beat this

B.R.C. 1 Crystal Receiving Sets, specially designed by an ex-Marconi Engineer and Chief Inspector to Government Telegraphs, 19 years experience. It comprises Brown's Headphones 4,000 Ohms, Sliding Inductance Range up to 3,000 Metres, fixed Condenser with Mica Dielectric, Variable Condenser, ¼" Ebonite Panel, Crystal Detector, Universal Ball and Socket Adjustment, Complete Aerial and Earth Equipment.

The set is compact, portable and enclosed in a polished oak case. It will receive Telephony up to 25 miles and Paris Time Signals and other principal stations. No batteries required. Approved by P.M.G. Reg. No. 207.

Price including the Broadcasting Fee
£4 10s. 0d. complete.

Demonstrations given any evening on this or our Valve Sets.

**THE BIRMINGHAM
RADIO COMPANY**
Carlton House, BIRMINGHAM

Telephone : Central 8025.

VARIOMETER

Our Latest Type for PANEL MOUNTING, made in Ebonite, in 3 windings :—

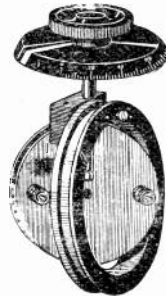

Max. Wave 200 Metres
" " 600 "
" " 1300 "

Price - 12/9
without knob & dial

Knob and Dial, as illustrated, 1/9 extra, postage 9d. Complete set of parts for making up, all work done without wire, 9/6. Large Stock. Immediate delivery.

**GOOD DISCOUNT TO TRADE-
F. Y. S.**

Accumulators

Best and Lowest Price.

4 volt 100 Amp. - - - - 30/-
6 volt 100 Amp. - - - - 43/6

Write for Lists.

F. YATES & SON, LTD.
WHOLESALE ELECTRICIANS,
144, Church St., Kensington, London, W.8

The London Telegraph Training College, Ltd.

Telephone : WESTERN 2696. Morse House, Earl's Court, S.W. ESTABLISHED 25 YEARS.

**OFFICIALLY RECOGNISED BY THE WAR OFFICE AND POST OFFICE AUTHORITIES
CABLE AND WIRELESS TELEGRAPHY.**

PARENTS desirous of placing their sons in either of the above Services and of affording them the best training facilities should apply for particulars of Courses and the methods of instruction which place this Institution in the first rank. **Cable Telegraphy** offers at the present time excellent prospects to youths from 15 years of age and upwards, and the College has exclusive facilities for obtaining posts for qualified students in the leading Cable Companies at commencing salaries of £150 to £300 per annum, with yearly increments of £12 to £25, and ultimate possibilities of obtaining positions as Supervisors, Assistant Superintendents, Managers, etc.

In the Wireless Telegraph Service the commencing remuneration at the present time is approximately £150 per annum, and Operators, when qualified by obtaining the Postmaster-General's Certificate of Proficiency, are nominated by the College for appointments. **No Correspondence Classes or Branches.**

DAY AND EVENING CLASSES.

Prospectus containing all information will be forwarded on application to THE SECRETARY (DEPT. H.), 262, Earl's Court Road, Earl's Court, London, S.W.5.

Sole Proprietors of the "Scott" Training Disc, which contains useful formulæ and other information for Wireless Telegraph Operators and is invaluable to Army Signalling Officers for range finding, etc.

Price, complete with instructions for use, 1/- Postage 2d.

THE WIRELESS WORLD EXCHANGE AND MART

TARIFF. Advertisements are accepted for this Section at the rate of twopence per word, with a minimum charge of two shillings. The advertiser's name and address will be charged for, and single letters and single figures will be counted as words. Compound words will be counted as two words.

DEPOSITS. All advertisements must be prepaid in the form of Postal Orders, the remittance being forwarded to Messrs. Bertram Day & Co., Ltd., 9 & 10 Charing Cross, S.W.1.

Intending purchasers may deposit the purchase money of any article advertised or sold by advertisers with Messrs. Bertram Day & Co., Ltd., who will acknowledge its receipt to the vendor and the depositor, the full addresses of whom should be given. Subject to special agreement between the parties, it is understood that all goods are sent on approval, each party paying carriage one way in the event of the goods being returned. The deposit will be retained until due advice of the completion of the purchase has been given or until the articles have been retained and accepted. In order to cover postage, etc., a fee of 6d. in respect of sums of £1 and under and 1s. for sums in excess of £1, must be paid at the same time as the deposit. For persons not resident in the United Kingdom these fees are doubled. We cannot undertake to receive any deposit less than 2s. 6d.

FOR SALE.

Variometers-Variocouplers, range 250 to 1,000 metres, especially necessary for Armstrong super sets. Prices 18s. and 25s. respectively. Cash with order.—M. ADAIR, 30, Bedford Place, London, W.C.1.

Brown H.I. Loud Speaker, 120 ohms, practically new. Perfect condition. Best offer taken. Transformer for same, 10s.—A. S. MILLS, 38, Mattison Road, N.4.

Amateur has For Sale.—Brown's Army Microphone Amplifier, perfect, £3 10s. Brown's 120 telephones, 30s. Mark 3 three-valve amplifier, with H.T., £3 15s. Loose couplers, £1 10s. and £1.—Telephone, Watford 71. BARKER, 85, Market Street, Watford.

Wireless Uniform. Height, 5' 10", £2.—Write L. CHORLEY, Bramble House, Fleet, Hants.

Burndept Two-Valve Panel, as new, £10.—DENNE, 16, South Terrace, Littlehampton.

Mark III Tuners, £8 10s. Brown's "A" Type telephones, 8,000, 42s. Valves, Amphon Junior Loud Speakers, £2 7s. 6d. Trade supplied at special terms.—TAYLOR, 41, Newlyn Road, Tottenham.

Amateur Wireless Experimenter, remodelling his station has for disposal—Tingey (brand new), three-valve receiving set, also two "A" coils, £7. Mark III* Tuner (brand new), converted to single-valve receiver, £9. 50-Watt (brand new) combined spark transmitter and crystal receiver, £5. 120-Watt Wilson Transmitter with D.C. motor and interrupter (as new), £5. Mark III Tuner (as new), £5. Three-valve C. Mark II L.F. amplifier (as new), £4.—"H," 129 Wells Road, Bath.

Two-Valve Detector Amplifier (L.F.), with two variable condensers in mahogany cabinet, £4 10s.—WAYFIELD Hurstwood, Uckfield.

Bankrupt Stock.—Huge advantageous purchase of wireless and electrical apparatus of South Coast Radio Co.'s stock, enabling us to offer at extraordinary prices. Everything new and guaranteed—must be sold regardless of cost.—Write stating requirements; stamps for list. PARAMOUNT RADIO Co., 10, Pelham Place, Seaford.

Sullivan Radio Frequency Tapped Transformer, new, £1 5s. Also Sullivan Inductance single layer, with magnetic reaction, as new, cost £5, accept £2 10s.—COMMON, Murray Place, Sterling.

.0005 Variable Condenser in polished wood case, 12s.; crystal detector, 3s.—HUNT, Drumberg, Burcott Road, Purley, Surrey.

Amateur has for Sale.—Three-valve receiver, tuner includes main and vernier condensers. Burndept coil holder, the valve panel is of the sloping type and may be extended, includes three filament resistances, two low frequency transformers, grid leak condenser. May be seen and tested after seven, by appointment. £15 or near offer.—WALKER, 17, Selborne Road, Handsworth Wood, Birmingham.

All Wireless and Electrical Goods stocked at 9, Colonial Avenue, Minories, near Aldgate Station. Handiest place for City buyers.—LESLIE DIXON & Co., Telephone No. Avenue 4166; B.A. Screws, Nuts and Washers, assorted gross 2s., lists 2d.—J. H. BENNETT, Station Road, Willesden Junction.

Wireless Masts.—Improved Girder Type, light and strong, 30 to 50 ft., at 1s. ft.; 50 to 100 ft., at 1s. 6d. ft. Cash with order, carriage forward.—F. ARMSTRONG, Weybridge.

Agate Cylinders, etc., for loud speaking apparatus from JAMES R. GREGORY & Co., Mineralogists, 139, Fulham Road, S.W.

Loud Speaker Horns, guaranteed perfect acoustics. Enamelled black matt, complete with polished aluminium base for receiver, 4s. 6d. Post, etc., 1s.—MIDLAND RADIOPHONE Co., Hearsall Works, Coventry.

Wireless Masts—Light and strong. Easily erected. Complete equipment, 16', 12s. 9d.; 22', 27s. 6d.; 45', 50s. Also parts and fittings. Stamp.—DERWENT MAST Co., 61, Arthur Street, Derby. Trade supplied.

Condenser Cases, finest quality teak, French polished, size 5 1/2 x 5 1/2 x 4 1/2, 3s. 6d. each. Other sizes proportionate, delivery from stock.—HITCHCOCK Colchester.

SPECIAL LOW FREQUENCY TRANSFORMER.

At the low price of 10/6 post free. Usual 20/- RADIOELECTRICO, 4, LITTLE TITCHFIELD STREET, OXFORD CIRCUS, LONDON, W.1.

High Frequency Transformers, Ranges with a .00025 Variable Condenser across the primary winding:



No. 1.	150-300 metres	3/6
No. 2.	300-600 "	3/6
No. 3.	500-950 "	3/9
No. 4.	900-1,800 "	4/-
No. 5.	1,700-3,000 "	4/6

These have an efficiency equal to any on the market.

A. WOOD, MANUFACTURER, 44, BRACEBRIDGE STREET, NUNEATON.

Your Case Work

Let us quote you for your wireless casework. We are specialists in this class of work and feel sure our workmanship and prices will interest you.

Phone—L.W. 2720.

CARRINGTON & NEWBERY LTD., 18/20, Normans Buildings, Old Street, E.C.

ELECTRADIX WIRES

Highest Conductivity at Lowest Prices.

Gauge.	D.C.C.	S.S.C.	D.S.C.
16	1 7/8	—	3 6
18	1 11/16	—	3 9
20	1 11/16	4 0	4 0
22	2 5/16	4 6	5 0
24	3 0	5 0	5 9
26	3 6	5 6	6 6
28	4 2	5 9	6 10
30	5 2	6 6	8 1 1/2
32	6 6 1/2	8 2	9 0
34	7 9	9 6	10 7
36	9 2	11 3	12 3 1/2
38	11 10	13 6	17 3
40	16 2 1/2	17 0	23 5

Other sizes in stock. Prices at per lb. 3d. extra for reeling off in small quantities and spool. Postage extra. 7/22 Hard Drawn Copper Aerial Wire. 4/6. Enamelled Copper 5/6 per 100 ft.

EVERYTHING FOR WIRELESS IN STOCK. **LESLIE DIXON & CO., 9, Colonial Avenue, Minories, E. 1** (near Aldgate Station.) Telephone: Avenue 4166.

ALL WIRELESS AND NAUTICAL INSTRUMENT WORK HIGHLY FINISHED.

Complete Sets and Parts quoted for. Makers of "Broadwave" Receiving Sets. P.O. Registered No. 168.

MOORES & GRIFFITHS LTD., BEXLEYHEATH.

Phone, Bexleyheath 114.



WESTON MOVING COIL RELAYS,

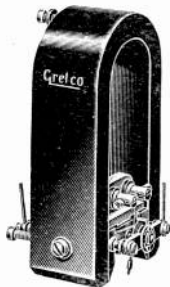

Undoubtedly the most Sensitive Relay made.

Platinum Contacts, eminently suitable for wireless recording or experimental work. Perfectly new as received from makers.

Price, 20/- each. Packing and post, 1/6. Note: These originally cost the trade £8 to £10 each.

Basket Coils (150 to 4,500 metres), excellent for telephony. Per Set ... 5/-

- Grid Leaks (enclosed), 2 meg. ... 1/-
- Aerial Wire, stranded, 7/25, 100' ... 3/-
- Filament Resistances ... 3/6
- Perikon Detectors on ebonite, complete with crystals ... 4/-
- Valve Holders, screwed legs ... 9d.
- Highly Glazed Green Egg Insulators. Best for aerials ... 4d.
- Knobs, best quality, with 2 B.A. brass inset ... 4d.
- Siemens Halske Valves, excellent for amplifying and rectifying ... 7/6

All Goods dispatched the same day as order received.

Catalogue in preparation.

Postage extra.

Grafton Electric Company

Showrooms—54, GRAFTON STREET, TOTTENHAM COURT ROAD, LONDON, W.1. Telephone—Museum 241. Works—Slough.

THE WIRELESS WORLD EXCHANGE AND MART

Wireless Insurance!

LIVERPOOL MARINE AND GENERAL INSURANCE CO., LTD.

London Office: 7, Angel Court, Throgmorton St., E.C.2.

FIRE. ACCIDENT. MARINE.

Write for particulars of our SPECIAL WIRELESS POLICY (Annual Premium 7/6) which covers fire and other damage to the complete Wireless Set and also indemnifies the Owner against claims arising from damage to property or persons through the breakdown of outside aerial and its supports.

To the Trade

CONNOLLY'S (Blackley) LTD.

Blackley, Manchester.

ENAMELLED WIRES for MAGNETS and AERIALS

London Office: 18, Victoria St., S.W. 1
Tel. Vic 6368. Telegrams: Lifehold, Vic

HEATH & Co., Ltd.

Instrument Works, New Eltham, S.E.9 are prepared to undertake in their fully equipped works—Wireless Apparatus and Parts for the trade. Quotations given to Blue Prints. Immediate attention.
Phone—Lee Green 301. Wire—Polaris, London.

PRESSLAND ELECTRIC SUPPLIES LTD.

Managing Director: CLIFFORD PRESSLAND, A.M.I.E.E., HAMPTON-ON-THAMES.

WHOLESALE ONLY.

Our 1923 Radio Catalogue is now ready and will be sent on application to any Bona Fide Trader.

WIRELESS SETS and PARTS

FREE The first order opened each morning for a month will be executed free (except for carriage), as an advertisement.

Send stamp for our Price List now.

WICKS & HAWKINS,

92, Kineswood Road, Brixton, London, S.W.

THOMPSON'S GOVERNMENT SURPLUS

Xmas Bargains

WIRELESS

100 COMPLETE RECEIVING CRYSTAL SETS.

All fittings on ebonite panels with tuner, one pair of best quality, highly sensitive Ericsson's 'phones or G.P.O., as requested, 100' aerial wire, insulators and 6 spare crystals, range 100 to 600 metres. Price, for complete set, 20/-. 'Phones alone worth the money. These sets are produced of all ex-Government surplus, and have been fully tested on broadcasting with excellent results.

1,000 PAIRS of ex-Government Wireless Head

'Phones, 7/6 a pair, less head band for crystal or valves. Ex-Army Telephone Transformers for these, 6/- each.

200 COMPLETE TRANSMITTING SETS, 65 metre,

containing 1" Sterling spark coil ebonite panels, condenser, high class spark gap and adjuster, large ebonite adjuster for trembler, cords and plug, beautiful folding transmitting key. These numerous parts, together with other fittings, are contained in one set, and all fitted in mahogany case, cost £12 each. Our price 17/6. No licence required to purchase.

WHEATSTONE BRIDGES, brand new, in cases,

good value, 20/- each, 100 in stock.

GALVANOMETERS, high class, Silvertown, useful

for above and sensitive testing, 10/- each.

PORTABLE FIELD TELEPHONES. Complete

in Teak Cases. Magneto ringing, transmitting and receiving. Cost £6, our price 15/- each.

RECEIVERS. Watch pattern, 75 ohms, complete

earpiece with cords. 1/9 each.

EX-ARMY MORSE TAPPERS AND SOUNDERS

OR BUZZER, mounted on polished base with heavy terminals and condenser. Cost £6 each, price with points 8/- each. Minus points, 6/-

HAND COMBINATION 'PHONES, complete

transmitter and receiver, and cords, useful for house or office 'phones, 4/6 each.

TELEPHONE MAGNETOS reduced to 5/- each.

SCRAP EBONITE, 1/- per lb., and 6d. per lb.

per quality of size.

BRAND NEW WATCH PATTERN MICRO-

PHONES, complete with insets and cords, aluminium cases. There is 1/6 worth of platinum in each of these. Cost 20/- each, our price 2/6.

DEWAR SWITCHES, 2/- each for wireless.

TELEPHONE TRANSFORMERS, 2 - each.

500 1-M.F. MANSBRIDGE CONDENSERS. New,

9d. each.

TERMINALS. Brand new I.B.A. 2/6 per dozen.

THOMPSON'S—continued.

A.C. MOTOR, 1/2 h.p. 200-250 volts, single phase, 50 periods. Makers Crypto, £4 10s.

Telephone switchboards, 'phones, field 'phones, as scrap, all useful for parts, 40/- per cwt.

PLUGS AND JACKS, per pair, 1/-.

TEAK CASES (GOVERNMENT), for mounting 2 or 3 valve sets with lock hinged lid. 2/6 each.

500 CHOKE COILS, 500 ohms each with iron core enclosed, useful for making transformers, etc. 1/6 each.

1,000 OHM CHOKE COILS, 1/- each.

TRANSMITTERS. W.T. sets forward spark. 20 watt, B., M.K. II rear, transmitter 80 (or 65) metres. These sets contain high class 1" Sterling spark coil, beautiful aluminium polished spark cap, with adjuster, condenser, ebonite adjuster, on and off switch, and battery plug, all mounted in mahogany case, waterproof. These sets are also brand new, costing £12 10s. each, to work off 6 volts. Price 20/- each.

Notice.—Amateurs are not required to have a transmitting licence to purchase any of the goods we advertise, and should therefore take advantage of our offer. Receiving came with a boom, and so may transmitting in the future.

3 H.P. CRYPTO, alternating current, 200 volt. 50 period, 2-phase motor with starter, a snip. £10 10s.

ARC LAMPS, 50 volts, 50 periods, makers A.E.G., all brand new and not out of wrappers, with electric variable rotator automatically adjusting carbon. Cheap enough to break up for experimenting. 18/- each, cost £4 10s.

CRYSTALS, GOVERNMENT SURPLUS.

CARBORUNDUM, selected crystals, 7/6 per gross.

2/- per doz.

COPPER PYRITES, selected .. 6/- per gross.

2/- per doz.

SILICON CRYSTALS, large .. 10/- per gross.

2/6 per doz.

GALENA CRYSTALS .. 7/6 per gross.

2/- per doz.

WOOD'S METAL, 8/- per lb. 800 lb. in stock.

We hold the largest stock of crystals in the country and should be pleased to receive tenders for above crystals and Wood's metal in hundred-weight lots.

DYNAMOS, 8 only, 75 volt 25 amp. shunt wound, 4 pole, brand new, speed 900, £15 each.

1" WIRELESS SPARK COILS, STERLING, 7/6 each.

1 1/2" WIRELESS SPARK COILS, 10/6 each.

FIELD SERVICE SEPARATORS, containing choke, 3 condensers, bridge and plugs, and numerous fittings in case. 7/6.

Notice.—Postage must be enclosed with order, all goods sent on 3 days approval against cash

Traders wishing to get a Xmas Stock, send at once.

T. W. THOMPSON & CO., GOVERNMENT SURPLUS DEPOT, 39, London St., Greenwich, S.E.10

THE WIRELESS WORLD EXCHANGE AND MART

GECOPHONE RECEIVING SETS APPROVED BY THE POSTMASTER-GENERAL FOR THE RECEPTION OF ALL BROADCASTING

No. 1 Crystal Set. Range 25 miles, £5 10s.
 No. 2 Crystal Set. Range 30 miles, £9 15s.
 complete with buzzer combined for fine adjustment of crystal. The above sets complete with aerial and all accessories.

Two-Valve Set Complete in mahogany cabinet with mahogany case for 'phones, and teak case with straps for accumulator. Range 100 miles, £25.

All the above sets are manufactured and guaranteed by The General Electric Co., Ltd. Write for Illustrated Lists.

WIRELESS SUPPLY,
 21, GEORGE STREET, HULL.

ESTABLISHED TWENTY-FIVE YEARS.

J. W. B.

ACCUMULATORS

RESULT OF OVER 40 YEARS' EXPERIENCE.

4v. 40a. .. 18/- 6v. 40a. .. 26/-
 4v. 60a. .. 21/- 6v. 60a. .. 31/-

PLATES, SETS, BOXES, SEPARATORS, REPLACEMENTS, EXPERT REPAIRS.

J. W. BARNARD

WORKS: 45, GT. ORMOND STREET, LONDON, W.C.1, and 4, GT. WINCHESTER STREET, LONDON, E.C.2

The Proprietor of the Patent No. 139496 for improvements in or connected with receivers of high frequency sound waves is desirous of entering into arrangements by way of licence and otherwise on reasonable terms for the purpose of exploiting the same and ensuring its full development and practical working in this country. All communications should be addressed in the first instance to **HASELTINE, LAKE & Co.**, Chartered Patent Agents, 28, Southampton Buildings, Chancery Lane, London, W.C.2.

The Proprietor of the Patent No. 139494 for improvements in or connected with multi-step thermionic amplifiers is desirous of entering into arrangements by way of licence and otherwise on reasonable terms for the purpose of exploiting the same and ensuring its full development and practical working in this country. All communications should be addressed in the first instance to **HASELTINE, LAKE & Co.**, Chartered Patent Agents, 28, Southampton Buildings, Chancery Lane, London, W.C.2.

The Proprietor of the Patent No. 139497 for improvements in or relating to electrically operated sound generators is desirous of entering into arrangements by way of licence and otherwise on reasonable terms for the purpose of exploiting the same and ensuring its full development and practical working in this country. All communications should be addressed in the first instance to **HASELTINE, LAKE & Co.**, Chartered Patent Agents, 28, Southampton Buildings, Chancery Lane, London, W.C.2.

The Proprietor of the Patent No. 139498 for improvements in or connected with receivers for use in connection with signalling by sound waves is desirous of entering into arrangements by way of licence and otherwise on reasonable terms for the purpose of exploiting the same and ensuring its full development and practical working in this country. All communications should be addressed in the first instance to **HASELTINE, LAKE & Co.**, Chartered Patent Agents, 28, Southampton Buildings, Chancery Lane, London, W.C.2.

WORKS FOR SALE.

PLANT FOR MANUFACTURING OF WIRELESS RECEIVING SETS.

Splendid works in South West London for sale. Complete with small modern machine tools, including lathes, gear hobbors and cutters, tapping machines, screw fly presses, polishers, grinders, etc. Works can be seen by appointment. Apply Mr. G. W. MARTIN, Sardinia House, Kingsway, London, W.C.2.

BACON AND COATES,
 Radio Supplies Depot, Royal Arcade, Keighley.
SPECIAL THIS WEEK.

- Flash Lamp Batteries for H.T., new, doz. 5/6
 - Flash Lamp Batteries for H.T., soldered .. 6/6
 - 100' 7/22 Copper enamelled wire. 5/-
 - Aerial Insulators, non-hygroscopic, each 4d.
 - Filament Rheostats, extra smooth, each 4/6
 - H.F. Transformers, 300, 400 and 600 metres 3/9
 - H.F. Transformers, formers only, each 2/3
 - L.F. Transformers, tested 1,000 volts .. 22/6
 - Switch Arms, 4-ply copper 2/6
 - Ebonite (guaranteed) 1b. 4/6
 - Contact Studs with nuts doz. 1/6
 - Condenser Vanes, polished pair 13d.
 - Condenser Washers, fixed vanes doz. 3/6d.
 - Condenser Washers, moving vanes, doz. 6d.
 - Condenser Spindles, according to length.
 - Condenser Screwed Rod ft. 6d.
 - Condenser Scales, engraved ebonite, each 3/6
 - Condenser, complete, '0005 each 13/6
 - Condenser, set of parts per set 11/6
 - Sistoflex, strong doz. 6d.
 - Terminals doz. 2/6
 - Dublier Condensers each 2/6 and 3/6
 - Do. Grid Leaks, 2 megohm each 2/6
 - Brown 'phones, new, 4,000 ohm pair 30/-
 - Stop Pins doz. 4d.
 - Split pins doz. 1/6
 - Mullard ORA Valves, tested each 15/-
 - B.T.H. Valves, tested each 15/-
 - Polished ebonite knobs each 6d.
 - Ebonite Valve Sockets, polished, screwed legs each 1/4
 - Ebonite Valve Sockets, polished, with flange each 1/10
- Orders over £2 carriage paid.

RESULTS

Whether as a source of practical information for the Amateur or as a valuable medium for every Advertiser, the **best results** are invariably obtained "Wireless World" through the

BERTRAM DAY & CO., LTD.
 Complete Advertising Service,
 9 and 10 CHARING CROSS, S.W.1

Portland's Parts by Post.

"EBONITE"

	s.	d.		s.	d.		
4 x 4	1	3	12 x 7	5	2		
7 x 5 1/2 .. .	2	8	12 x 8 1/2 .. .	6	5		
8 x 6	3	0	12 x 10	7	6		
9 x 6	3	5	15 x 8 1/2 .. .	8	0		
10 x 6	3	9	12 x 12	9	0		
12 x 5 1/2 .. .	4	2	17 1/2 x 8 1/2 ..	9	6		
9 x 8 1/2 .. .	4	10	14 x 12	10	5		
7 x 5	5	3	18 x 18 (1/2-shee.)	12	10		
			36 x 18	£1	3	0	
7 lbs.	£1	3	0	28 lbs.	£4	0	0

No charge for cutting, waste or postage.
 Delivery by return of post.
 Quality A 1. DRILLING, manufacture—BRITISH
 Thickness One Quarter: Surface Mat.

JAMES PORTLAND
 39, Sinclair Road, Olympia, W.14
 N.B.—Mr. Portland stocks 200 Wireless Parts.

SPLENDID CHRISTMAS PRESENT

ESTABLISHED **ALLISON & CO.** 20 YEARS

"SETS" CRYSTAL £3 with 4000 ohms
 VALVE £5 DOUBLE HEAD PHONES

ALL SETS WILL BE MARKED **B B C** AND **P M G**

Send for particulars and testimonials

46, 46d and 50, 50a, CHURCH ROAD, ACTON

EBONITE SHEET.

LOW PRICES. HIGH GRADE MATERIAL. USUAL SUBSTANCES IN STOCK.
 FULL SIZE SHEETS OR CUT TO SIZE. Quotations on receipt of particulars.

R. C. HILLS, 48, FENCHURCH STREET, LONDON, E.C.3

THE WIRELESS WORLD EXCHANGE AND MART

**Have you seen them ?
Have you heard them ?**

L.F. TRANSFORMERS.
The last word in efficiency. Price 21/- each

H.F. PLUG-IN TRANSFORMERS.
350-450 metres Price 6/6 each
900-1,100 metres Price 7/6 each

Manufactured at our Works.
Liberal discounts to the Trade.

P. H. BOYS & CO.,

Electrical and Wireless Engineers,

187, Goswell Road, London, E.C.1.

'Phone : - - - - - Clerkenwell 4454.

MISCELLANEOUS.

If you require a full experimental receiving and transmitting licence you must satisfy the G.P.O. that you have a sufficient knowledge of W.T. science to warrant the issue of such a licence.—THE LONDON TELEGRAPH TRAINING COLLEGE, LTD., will give you the necessary qualifications in 12 lessons. Write for full particulars of evening lectures to Secretary (Dept. A.T.), 262, Earl's Court Road, S.W.5.

East Ham, Wanstead, Ilford, Manor Park and Forest Gate. Amateurs should not fail to come to the **RADIORENDEZVOUS**, 709, Manor Park, Broadway (over Lipton's). Club open till 10 p.m. nightly.

Telephones Rewound to any Resistance. Telephone re-windings a speciality. 11s. to 4,000, 12s. to 8,000. Returned 24 hours. Cash with order.—**MAGNETO SERVICE CO.**, 4, Newington Causeway, S.E. Hop. 2627.

Telephone Receivers Rewound up to 1,000 ohms, 5s. each, 2,000 ohms 7s. 6d. Cash with order.—**M. E. HAMPSHIRE**, 139, Sydenham Road, S.E.26.

FOR SALE—continued

Huge Purchase of Ex-Government Wireless Stock.—Write for list giving full details. 150-watt dynamos, £1; loud speakers, 200 ohms, 7s. 6d.; 1" spark coils, 10s.; 1½" spark coils, 12s. 6d.; Morse tapping keys, 3s., etc., etc., etc., etc. Three days' approval against cash, or please call. Write for detailed price list of all goods.—**E. J. GALPIN**, 16, Loampit Hill, Lewisham, S.E.13, London.

Woodsmetal. 3 cwt. Best offer in large or small quantities.—**B.S.A. Birmingham.**

SITUATIONS WANTED.

Engineer (22), First-class P.M.G., used to small fitting, turning, etc.—**A**, 59, Palmerston Road, Buckhurst Hill.

Wireless Operator (22).—Four years' experience, seeks situation.—**B**, '9, Gew's Corner, Cheshunt, Herts.

TRADE ENQUIRIES.

Will Manufacturers of Wireless Sets kindly forward trade lists and agency terms to—**J. A. MARNIE**, Wireless Engineer, 107, High Street, Montrose.

Wireless Dealers throughout Great Britain are strongly advised to stock parts for making up wireless sets. Buy your parts direct from the factory at wholesale prices.—**NEWTONIA WIRELESS FACTORY**, 13 and 15, Whitcomb Street, W.C.2.

AGENTS WANTED.

"Daco" High Tensile Tapered Steel Masts.—The best for strength, durability, scientific construction and appearance. Provincial agents wanted.—**"A"**, 93, Stamford Street, London, S.E.

Old-established London Firm, making one to five-valve broadcast receivers, desires provincial agents. Every assistance and good terms offered.—**Box 76, c/o F. ALDRIDGE**, 26, Paternoster Row, E.C.4.

ALL BRITISH PHONES

21s. per pair. Post Free. (4,000 ohms)

Illustrated Catalogue including List of Stations, 6d. Post Free.

BOYS WIRELESS SUPPLY CO.,
:: :: 115, Fleet Street, E.C.4. :: ::

The Christmas Gift this year, the perfect Wireless Receiver, made by Marconi's.—**PRICES**—Crystal-Junior, £5 15s. Crystal A, £9 10s. Model V.2, £25. Broadcasting has been heard over 100 miles with the V.2 Model. The guaranteed range of 50 miles ensures very clear reception.

We are Marconiphone Distributors—Write Now
COLCHESTER WIRELESS INSTALLATION CO., STANWAY, COLCHESTER.

BOOKS.

Technical Books.—Second-hand and New Books on every conceivable subject. Catalogue free. State wants. Books sent on approval Books bought.—**FOYLE**, 121, 125, Charing Cross Road, London.

Radio Magazines, all the latest, "Radio World," 10d.; "Popular Radio," 10d.; "Radio Broadcast," 1s. 6d.; "Radio News," 1s. 6d.; "Science and Invention," 1s. 9d.; "Scientific American," 2s. 6d. Post free.—**INTERNATIONAL NEWS COMPANY, LTD.**, 15, Bream's Buildings, London, E.C.4.

TELEPHONES

BROWN, A. (new ex-Gov't)	£	s.	d.
8,000 ohm	...	2	9 6
120 ohm	...	2	2 6
SULLIVAN (new ex-Gov't)			
8,000 ohm	...	1	16 6
120 ohm	...		12 6
Best Cords for above	...		3 6
British made Phones, with			
Cords, 4,000 ohm	1		1 0
French made Phones with			
Cords, 4,000 ohm		18	0

ACCUMULATORS

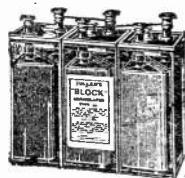

FULLER BLOCK	£	s.	d.
16 amp. ign.		7	0
40 "		16	3
80 "	1	4	0
120 "	1	8	0
FULLER PLATE			
30 amp. ign.		9	0
80 "		14	0

Parliphone Loud Speakers ... £1 12 6

EVERYTHING FOR WIRELESS. 3 Valve L.F.-Amplifiers £4 : 5 : 0. Crystal Outfits, Complete from £2 : 7 : 0. Valve Sets for 1 to 4 valves. All Accessories and Parts at competitive prices. Postage free on orders over £1. For smaller orders please enclose sufficient postage, any surplus will be returned.

H. V. ALBROW

WIRELESS ENGINEER.

'Phone :
Mayfair 5842.

56, GEORGE STREET,
BAKER STREET,
LONDON, W.1.

2 minutes walk to the rear of Selfridge's.

ATMOSPHERICS

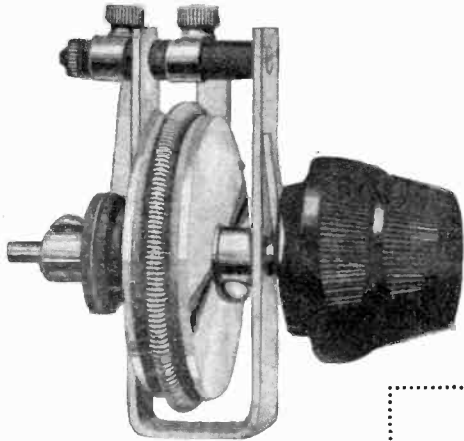

Type No. 11601/HI Filament Rheostat with Vernier Adjustment.

IT may be an easy explanation for your friends when these ear-splitting sounds occur, but come down to facts. Your filament rheostat or intervalve transformer may be the seat of trouble.

“IGRANIC”
Filament Rheostats
 and
Intervalve Transformers
 were designed to eliminate all such troubles.

ASK your dealer to demonstrate to you on a set with these items incorporated.

THE clarity of tone and freedom from “statics” will be a revelation to you.

Fit them on your own set. Your dealer can supply them from stock. Write for descriptive pamphlet U1.

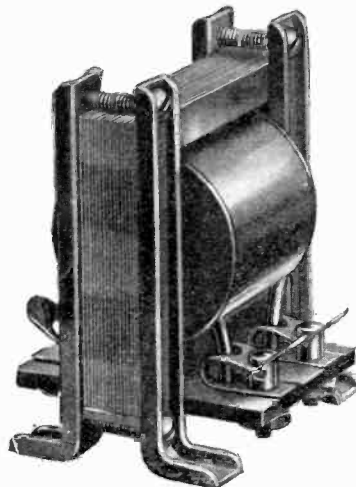

Low Frequency Intervalve Transformer

Manchester—30, Cross Street
 Birmingham—73, 4, Exchange Buildings
 Glasgow—50, Wellington Street

**149, Queen Victoria St.,
 LONDON**



Cardiff—Western Mail Chambers
 Bradford—18, Woodview Ter., Manningham
 Newcastle—90, Pilgrim Street

**Works :
 Elstow Road, BEDFORD**

C.A.Co.

An Ideal Xmas Gift—Order Now

The Best Value in Single Valve Panel Sets on the market

No Finer Set could be built if 20 times the price were paid

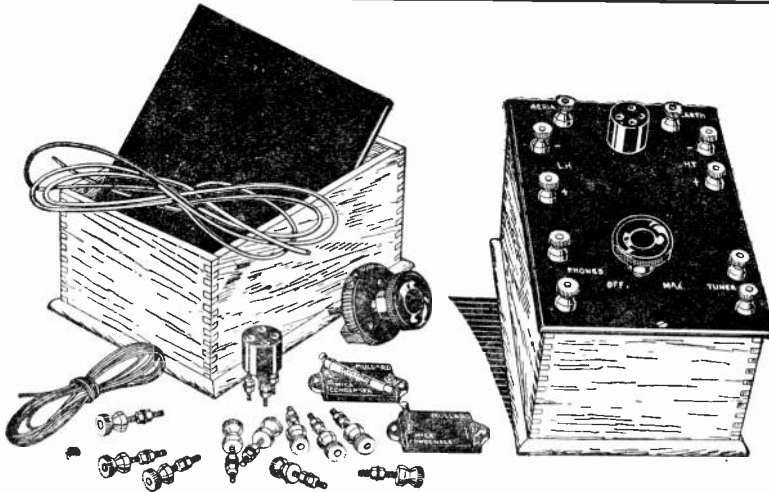

30/-

Complete

Comprising — Handsome polished mahogany cabinet, panel of best quality ebonite, well finished and bevelled edges, valve holder, filament resistance, 2 Mullard's Condensers, .0003 and .0002 mfd. Mullard's Grid Leak, 10 Terminals, 10 engraved terminal tablets, coloured systoflex and copper wire, blue print with full instructions.

Hundreds of these sets have already been sold. As will be observed, **ONLY THE VERY BEST COMPONENTS ARE SUPPLIED.** This is the secret of the success and popularity of this panel.



A Good Pair of Phones makes an exceptional Xmas Gift that will be appreciated by the recipient.

BROWN "A" TYPE, Aluminium Diaphragms at much below makers' prices.		(Cords 3/6 extra)
120 ohms (maker's price 58/-)	£2 2 6	
120 ohms Complete with Telephone Transformer (Value 25/- in Iron Case)	2 15 0	
8,000 ohms (maker's price 66/-)	2 9 6	
SULLIVAN PHONES (with Brown's Aluminium Headbands).		
120 ohms	12 6	
120 ohms Complete with Telephone Transformer (Value 25/- in Iron Case)	1 10 0	
8,000 ohms	1 18 6	

All our goods are sent on approval, against cash, for seven days.

THE CITY ACCUMULATOR CO., 79 Mark Lane, London, E.C.3

Phone: AVENUE 1316.

Wholesale and Retail Distributors for Messrs. BURNDIPT, Ltd. Same Trade Discount Allowed as by Manufacturers.

AGENTS—London: H. V. ALBROW, 56, George Street, Portman Square, W.1.

Glos.: BRISTOL WIRELESS Co., 52, Cotham Hill, Bristol.

Leicester: WALTER ROWE, LTD., 96, Granby Street, Leicester.

S. Wales: SOUTH WALES WIRELESS INSTALLATION Co., LTD., 18, West Bude Street, Cardiff.

N. Wales, Lancs., Ches. & I.O.M.: THE "ALL-BRITISH" WIRELESS MANUFACTURES Co., LTD., 18, Vauxhall Road, Liverpool.

C.A.Co.

IMPORTANT NOTICE to all Amateurs, Experimenters, Manufacturers and Retailers.

We have completed the purchase of the largest stock of

Ex-Govt. Wireless Material

Ever handled by an individual firm, and it is our intention to offer the same for re-sale at astonishingly low prices in accordance with our inevitable rule to

SHARE OUR BARGAINS WITH OUR CUSTOMERS

We would again emphasise the fact that

It is unnecessary to pay fancy prices for ex-Disposal Board Wireless Apparatus.

As an example of the bargains that are to follow, we are offering the following preliminary items :

RECEIVERS, C.W. MARK III

This set comprises a complete 2-valve Receiving Set, with a wave-length range of 350-1,800 metres. The addition of High and Low Tension Batteries, valves, and phones completes the entire receiving station. For the reception of Broadcast concerts this set is ideal, the strength and clarity of the signals being absolutely wonderful. London readers should take the opportunity of hearing this set working at our Showrooms. **Only 200 left. Price £9 9s.**

Complete with 4-volt 40-amp. Fuller Block Accumulator, 60-volt H.T. Battery, 2 Mullard "ORA" Valves, and pair of Brown "A" Type Headphones, complete with cords **£15 10s.**

AMPLIFIERS, C. MARK IV

This instrument is a complete 3-valve low frequency amplifier, and can be used in many ways without modification.

The C. Mark IV Amplifier is an improvement on the C. Mark III (the latter being sold by other dealers at £6 5s. each without cases), inasmuch as the C. Mark IV contains terminals and change-over switch, allowing the use of the instrument for either high or low-frequency amplification.

The price at which we are offering these amplifiers is less than the actual value of the transformers contained in the instrument. **Price, complete in Mahogany Case.. £4 5s.**

INSULATED AERIALS

40-feet, 1s.

60-feet 1s. 6d.

Kindly note that the above prices do not include packing and carriage. Please add, therefore, an appropriate amount to cover this. Any surplus will be refunded.

C.W. TRANSMITTERS, MARK III, 30-WATT

For two valves. Complete, with aerial, ammeter, platinum-pointed Morse Key, in mahogany case. Wavelength range, 300-1,800 metres.

NOTE.—This set can be conveniently converted into a 2-valve **Detector-Amplifying Receiver.**

Price **£3 5s.**

B MARK II RECEIVERS

Vertical pattern. Can be easily converted to any wavelength.. .. **£3 15s.**

Above, fitted with Variable Air Condenser, .0005 mfd., in place of change-over switch. **£4 15s.**

HETERODYNE WAVEMETERS, 500-3,000 METRES

For Receiving, without Galvanometer **£2**

For Transmitting and Receiving, containing Weston Galvanometer **£3**

AERIAL MASTS AND EQUIPMENT

15-foot Steel Masts in Sections, each 2 ft. 8½ ins. complete with Halyard, Pulley, and Stays. Can be erected by one man, and are portable. The height can be increased up to 30 feet by the use of extra stays. **Per Set Complete, 15s.**

30-foot DITTO, in SECTIONS, each 4 ft. 3 in. (without stays). **Per Set Complete .. 17s. 6d.**

SULLIVAN HEADPHONES

120 ohms **12s. 6d.**

SULLIVAN HEADPHONES

120 ohms complete with new Telephone Transformer (value 25s.) in iron case **£1 10s.**

THE CITY ACCUMULATOR CO. 79, MARK LANE, LONDON, E.C.3

Phone—AVENUE 1316.

Wholesale and Retail Distributors for Messrs. BURNDEPT, Ltd. Same Trade Discount Allowed as by Manufacturers.

AGENTS

London: H. V. ALBROW, 56, George Street, Portman Square, W.1.
Glos.: BRISTOL WIRELESS CO., 52, Cotham Hill, Bristol.
Leicester: WALTER ROWE, LTD., 96, Granby Street, Leicester.

S. Wales: SOUTH WALES WIRELESS INSTALLATION Co., LTD., 18, West Bude Street, Cardiff.
N. Wales, Lancs., Ches. & L.O.M.: THE "ALL-BRITISH" WIRELESS MANUFACTURES CO., LTD., 18, Vauxhall Road, Liverpool.

EXPERIENCE

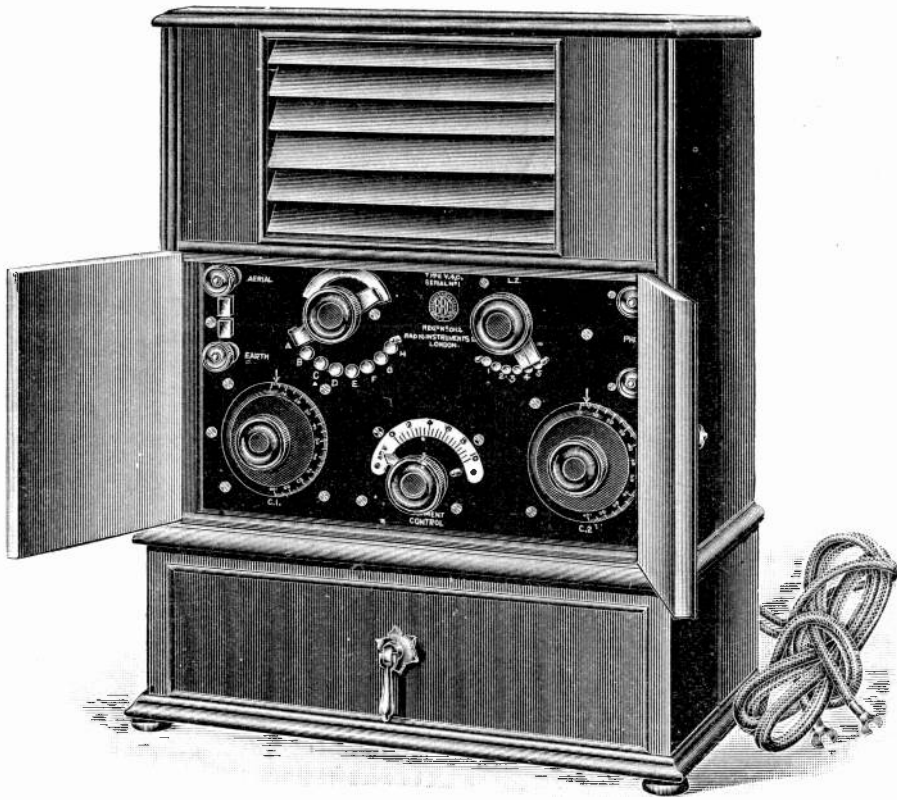

An Ideal Xmas Present :

The Lyrian

The latest and most efficient Table Cabinet Receiver for broadcasting.

This portable cabinet of classic design is a 4-valve Amplifying Receiver, comprising one high-frequency, one detector and two note magnifiers. A powerful Loud Speaker giving the clearest reproduction, sufficient to fill a drawing-room, etc., is contained inside the cabinet with a concealed type of horn.

Everything is self-contained except the accumulator battery. The Cabinet is designed to close up without removing any wires so that it is always ready for use.

In flats and places where the erection of an aerial is not suitable, it can be used in conjunction with our approved frame aerial. The price includes the accumulator battery and broadcasting royalty ..

45 Guineas

Agents.

London :—Harrods, Ltd.

Manchester (Sole Concessionaire for the North of England) : Northern Radio Co., 30, Arcade Chambers, St. Mary's Gate, Manchester.

Birmingham (Sole Concessionaires for the Midland Counties) : Electrical Trades Supply, Ltd., Gt. Charles Street, Birmingham. Sheffield and District : Wilkins & Jackson, Ltd., 22, High Street, Sheffield.

Aberdeen and North of Scotland : Lawson, Turnbull & Co., Ltd., 8 to 18, Mealmarket Street, Aberdeen.

Swansea and District : Dan Morgan, 218, Oxford Street, Swansea. Cambridge : Baily, Grundy & Barrett, Ltd., 2, St. Mary's Passage, Cambridge.

Liverpool : Lewis's Ltd., Ranelagh Street, Liverpool. Reading and District : Reading Radio Supplies, 32, Castle Street, Reading.

Oxford : F. E. Wootten, Ltd., 56, High Street, Oxford. Glasgow : Rex Import Co., Ltd., Rex House, 202, Bath Street, Glasgow.

Glasgow : Archibald Low & Sons, Ltd., 28a, Renfield Street, Glasgow.

Rochdale (and Branches) : Dean & Holt, 78, Yorkshire Street, Rochdale.

RADIO INSTRUMENTS LIMITED

Managing Director : J. Joseph, M.I.E.E., late Manager to Mr. H. W. Sullivan, Chief Designer : W. A. Appleton, M.B.E., M.I.R.E., late Admiralty Technical Research Officer.

ONLY ADDRESS.
Works, Offices and Showrooms :
Telephone : Regent 1908.

12, Hyde Street, NEW OXFORD ST., W.C.1

Telegrams : Instradio, London.

(B.P.S.18)



Reliance Radio Service Co.

THE "RELIANCE" CRYSTAL RECEIVING CABINET.

CONSISTING of Ebonite Panel mounted in Oak Cabinet with lid; Tuning Coil and condenser, Patent Crystal Detector totally enclosed in glass; 4,000 ohms; Double Headphones; 100 feet stranded copper wire; 2 shell insulators. No further outlay. No batteries required. Each set has been tested and carries our guarantee, and we confidently assert that for the price it is the most compact and reliable that is obtainable.

PRICE COMPLETE

£3 : 5 : 0

INSTRUMENT ONLY

£1 : 12 : 6

We have also a complete range of Valve Sets in stock from £7 to £20. Call and inspect the famous FELLOPHONE 2-Valve and 4-Valve Receiving Sets, prices complete, £10 10s. to £17 10s. respectively. Also the FELLOCRYST SUPER Crystal Receiving Set, price £4 7s. 6d. complete. All our sets are passed by the P.M.G. for reception of broadcasting. All sets open to inspection at our London address. Demonstrations given daily. Hours 10 a.m. to 6.30 p.m.

Illustrated Catalogue post free.

RELIANCE RADIO SERVICE Co.

283, St. John Street, Clerkenwell, London, E.C.1

PHONE—CLERKENWELL 4290.

RADCOM TRIPLUG TUNERS



Consisting of three separate units for Panel Mounting complete with spring clip terminals

Price 8/6

Extension Handles, extra per pair 1/6

Triplug units assembled on base, ready for Panel Mounting, complete with spring clip terminals

Price 16/-

Extension Handles, extra per pair 1/6

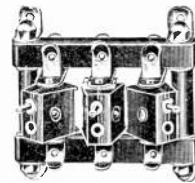

Independent Type.

RADCOM RHEOSTATS, TRANSFORMERS, BATTERIES. Write for Catalogue.

Assembled Ty e.

Radio

COMPONENTS LTD.

12/13, HENRIETTA STREET,
LONDON, W.C.2.

'Grams: Radponents, Rand, London. 'Phone: Gerrari 792 E.P.S.

WITH GOOD APPARATUS YOU
CAN GET GOOD RESULTS
THE "W.P."

Morse Practice Key

Well Made. First-class Finish. Thoroughly Reliable.

Price 7/6 Post Free

THE WIRELESS PRESS, LTD.
12-13, Henrietta Street, London, W.C.2

Questions and Answers COUPON

To accompany Questions
sent in during the week
commencing Dec. 16th, 1922.

VOL. XI, NO. 11.

See Conditions on Page 383.

Christmas Presents

INSTRUCTIVE
AMUSING
ENTERTAINING

The "Broadway" Crystal Set—Type A

Approved by the Postmaster-General for the Reception of Broadcasting. Regd. No. 263.

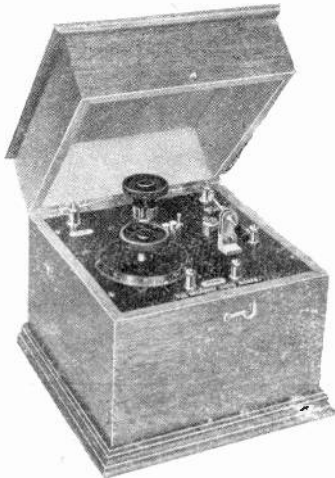

Similar to set we illustrate, but slightly larger. Designed to receive the **TIME SIGNALS** from the **EIFFEL TOWER**, as well as **BROADCASTING STATIONS** and **Amateur Telephony**.

Complete with pair of First Class High Resistance Telephones, 100 ft. Stranded Aerial Wire, 2 Shell Insulators, and Aerial Pulley.

PRICE £5 : 15 : 0

The "Broadway" Note Magnifier

Single Low Frequency Units to fit above Crystal Set, in French Polished Mahogany Cabinet, Matt Ebonite Panels, Bevelled Dial on Filament Rheostat. First class finish.

Approved by the Postmaster-General. Reg. No. 3073.

PRICE OF INSTRUMENT ONLY, £4 : 0 : 0

Including Royalties.

Price of Instrument complete with H.T. Unit and Fuller Block Accumulator, £6 : 10 : 0.

TRADE ENQUIRIES SOLICITED.

The Broadway Radio Works,
DEVONSHIRE ROAD, BEXLEYHEATH, KENT.

The "Sound Wave"

AND

Gramophone Journal

TRADE AND TECHNICAL

The most authoritative Journal in the Kingdom on matters pertaining to the Gramophone.

SPECIAL ARTICLES ON

MUSIC - - - ACOUSTICS

SOUND BOXES

TONE ARMS

TONE CHAMBERS - STYLI

and all other accessories incidental to Gramophone construction.

100 Pages. 4^d Monthly.

From usual newsagents or direct from the publishers—Messrs. DUNLOP & CO., 1 & 2, Whitfield St., Tabernacle St., London, E.C.2

Dry Batteries for Wireless Sets

No 1 W. Standard Pocket-lamp size, 4½ volts (as illustration), with patent spiral wire terminals for connecting in series.

Insert straight terminal in spiral of next battery and bend same, no soldering required.

PRICE 7/- Per doz.

NOTE.—(1 doz. = 54 volts).

NEW TYPE.

No. 2 W. Slab.

15 volts, 1 screw terminal, 5 plug sockets, 3-volt tappings with wander plug.

Size . . .
9" x 2½" x 2½"
high.

PRICE

3/-

EACH

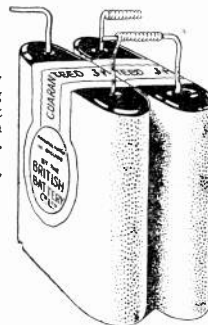

NEW TYPE.

No. 4 W.

36 volts, 1 screw terminal, 12 plug sockets, 3-volt tappings with wander plug. Size 9½" x 1½" x 2½" high.

PRICE

7/-

EACH

No. 1 W.
Connect as illustration.
(Patent applied for).

BRITISH MADE—CARRIAGE PAID.

Manufactured by—
THE BRITISH BATTERY Co., Ltd.
Clarendon Rd., WATFORD, HERTS.
(Telephone : Watford 617.)

GREAT BARGAIN OFFER

To Readers of the "Wireless World"

For a short time only
— while the stock lasts.

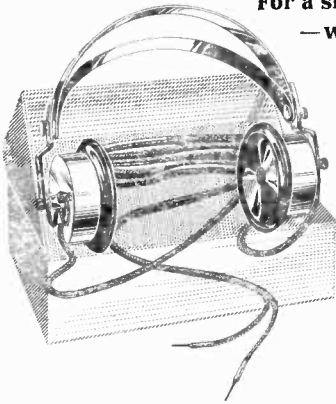

2,000 Pairs only

4,000 ohm

PHONES

(NEW)

at

17/6

PER PAIR.

Postage 9d. extra.

Fitted headbands and cords, beautifully finished, thoroughly efficient. Each pair carefully packed in box. Satisfaction guaranteed.

A wonderful bargain, never before offered and cannot be repeated. Readers of the "Wireless World" are urged to take advantage of this astonishing offer immediately. All orders will be executed in strict rotation.

Broadcasting Receiving Apparatus

The "JOYPHONE" (Reg. No. 0133) Approved type.

2-Valve Set complete from £15 : 0 : 0

TERMINALS.

4 B.A. Double Solid Brass or Plated, 2/- per doz. (post. extra)
2 B.A. Single " " " 9d. " " " "

Special Offer at Reduced Prices of our

NEW Intervalve Transformer

Owing to the unexpectedly large sale of these instruments, we are enabled to reduce the price to "Wireless World" readers to—

14/- postage 9d. extra.

Fitted with panel fixing plate and earthing wire for iron core. Fully tested. Ratio 5 : 1.

To obtain goods at these special bargain prices, please mention the "Wireless World"



We have ENORMOUS STOCKS OF EX-W.D. WIRELESS GEAR, too numerous to mention, at absurdly low prices. Write for particulars of your requirements or, better still, call and see our enormous stocks.

All valve apparatus manufactured by us is duly licensed under Marconi patents for amateur use in Gt Britain. Approved by Postmaster-General.

J. LIPOWSKY & CO.
614, Old Ford Rd., Bow, London, E.3

Telephone—East 3345.

Near Old Ford Station, N.L.Ry.

Nos. 8 or 39 'Bus

A BARGAIN
£85

Cannot replace under £285

Electric Lighting & Power Plants
for Country Houses
Workshops, Cinemas

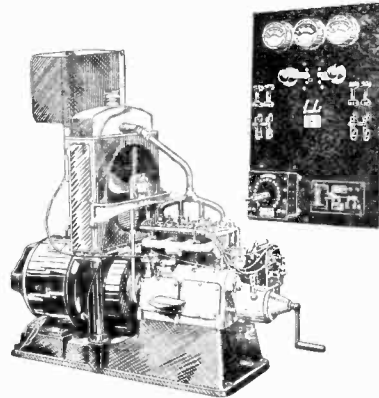

AUSTIN and STANDARD 3½ K.W. and 4½ K.W., 110 volt, direct coupled LIGHTING AND POWER PLANTS, complete with ordinary switchboard £85 f.o.r. Special battery charging switchboard as above, £15 extra. Every set guaranteed. Suitable for either 110 volt or 50 volt country house lighting, garage, workshop or cinema plants.

DOUGLAS 2 cylinder, 3½ K.W. plants in stock, all prices. Large quantities of spare parts for all above sets always in stock at low prices. Complete workshops, Drummond and Colchester 5½ in. lathes, Luke and Spencer grinders, Wolfe electric drills, wall drills, etc., together with 110 volt meters.

C. H. & L. O. SMITH,
75, Canal St., Nottingham

HEADPHONES !!

Buy French Headphones Now and Save £ s. d.

Headphones of French manufacture are seldom equalled for sensibility and workmanship. Efforts are being made to prohibit importation. Therefore buy now. Owing to the present favourable rate of exchange, we can offer various makes at the following extraordinary prices :—



List No.	Make.	Total Res. in ohms.	Brief Specifications.	Retail price.	Postage.
201	Picard	4,000	Moulded ebonite receivers, double duralium straps, fully adjustable	21/-	9d.
202	"	8,000	Ditto	22/6	9d.
203	"	2,000	Receivers only, complete with cords	8/-	5d.
204	Brunet	4,000	Aluminium receivers, double oxidised steel straps, fully adjustable, extra long cords	23/6	9d.
205	Thomson-Houston	3,000	Highly polished detachable receivers, single nickel-plated light steel spring strap. Particularly suitable for ladies	23/6	9d.
206	"	3,000	As above, but with double straps, fully adjustable	24/6	9d.
207	"	4,000	As above, single strap	24/6	9d.
208	"	4,000	As above, double straps	25/6	9d.

Satisfaction Guaranteed. Liberal Trade Terms. Send for List to-day.

W. JOANES, 42 Jenner Rd., Stoke Newington, London, N.16
(PARIS and LONDON.)

RIMAR COILS MARK A CONSIDERABLE ADVANCE TOWARDS THE IDEAL INDUCTANCE

It is no longer possible to annul the high resistance of aerial coils by reacting into them. The great loss of signal strength which is experienced when sets are altered to conform to the present regulations is not wholly caused by the disuse of reaction, but to a large extent is due to the fact that the performance of poor inductances can no longer be bolstered up by regeneration.

THE RIMAR COIL is the only commercial plug-in coil which has been specially designed to meet the changed conditions.

THE RIMAR COIL is a first-class coil.

RIMAR COILS are based on the best practice of the present day.

RIMAR COILS have in their smaller sizes a self capacity of from one-fifteenth to one-twentieth that of much boosted "Patent" coils, and below 600 metres range are constructed of properly cottoned Litz. conductor, larger sizes being crosswound with ample sized wire by special machinery.

RIMAR COILS are fitted with solid and genuine polished ebonite plugs and plated brass parts.

RIMAR COILS are damp proofed with finest synthetic resin and are neatly taped.

EVERY RIMAR COIL is guaranteed to be free from signal wasting internal shorts.

RIMAR COILS ARE GUARANTEED TO BE FREE FROM INFRINGEMENT OF THE DE FOREST PATENT.

The smaller RIMAR COILS can also be supplied wound with solid 18 to 20 S.W.G. wire.

Technical and Commercial Particulars mailed on request by the Sole Manufacturers :—

THE RIMAR COIL MANUFACTURING CO., 11, Vowler St., London, S.E.17

The FELLOCRYST SUPER



WIRELESS BROADCASTING

This is a high grade crystal detector especially designed for receiving broadcasting, and complies with all regulations. Beautiful pure clear speech and music are received, and as many as 3 pairs of Fellows 4,000 ohms double headphones can be simultaneously used. The "Fellowcryst Super" is mounted in a highly polished oak cabinet and is sent out complete with 100 ft. coil of 7/22 stranded copper aerial wire, two shell insulators and one 4,000 ohms double headphone, and is **British Made Throughout.**

PRICE COMPLETE £4 : 7 : 6

POSTAGE 2/- EACH.

EXTRA 4,000 OHMS DOUBLE HEADPHONES 21/-

POSTAGE 1/-

FELLOWS MAGNETO Co., Ltd.

LONDON, N.W.10.

Telephone: Willesden 1560-1.

Telegrams: Quizmag, Phone, London

For they are jolly good Fellows

BROADCASTING RECEIVERS

□□□

All Sets Bear the B.B.Co. Seal and are Fully Approved by H.M. Post-master-General

□□□

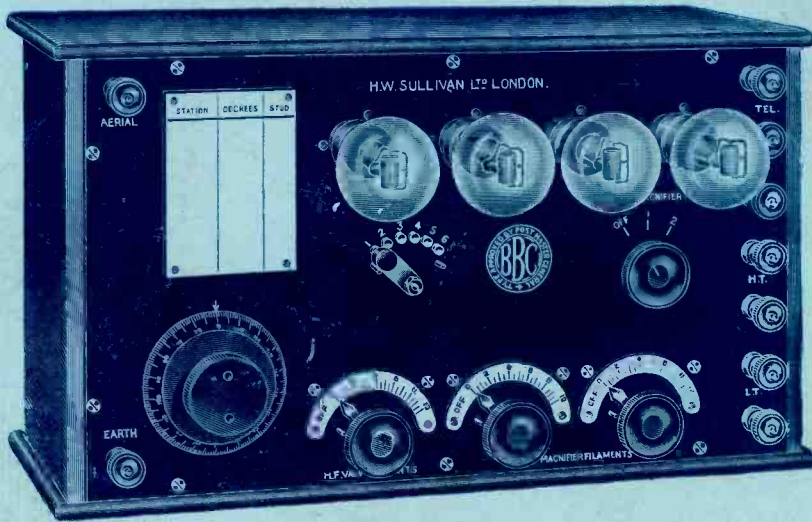

□□□

All Prices Include B.B.Co. Commission and Royalty to Marconi's W/T Co. Ltd.

□□□

LIST No. 514 A

Crystal Receiver, Patent applied for -	List No. 500	£2 17 6	
Crystal Receiver, with Phones and Aerial -	List No. 500A	4 17 6	Valves
Single Valve Note Magnifier for above -	List No. 501	4 12 6	for
Two Valve Note Magnifier for above -	List No. 502	7 2 6	These
Combined Crystal and Valve Set -	List No. 503	9 5 0	Sets
Complete Two Valve Cabinet Receiver -	List No. 512	14 15 0	M.O.
Complete Three Valve Cabinet Receiver -	List No. 513	19 0 0	Type
Complete Three Valve Cabinet Receiver -	List No. 513A	21 0 0	17/6
Complete Four Valve Cabinet Receiver -	List No. 514	23 15 0	Each
Complete Four Valve Cabinet Receiver -	List No. 514A	26 5 0	
Complete Five Valve Cabinet Receiver -	List No. 515	30 7 6	

□□□

WRITE FOR OUR CATALOGUE OF BROADCASTING RECEIVERS, Now Ready

□□□

DEMONSTRATION AND SHOWROOMS: Liverpool House, Middlesex Street, E. 1
Two minutes walk from Liverpool Street and Broad Street Stations. **TRADE TERMS ON APPLICATION.**

Works :

"LIVERPOOL HOUSE,"

H. W. Sullivan, Ltd.

Offices :

WINCHESTER HOUSE,

Middlesex St., LONDON, E.1

Formerly H. W. SULLIVAN, Founded in 1900

LONDON, E.C.2, ENGLAND

Phone—Avenue 4871.

Telegrams—"Deadbeat, Stock, London."

Phone—London Wall 3518



Printed by Sanders Phillips & Co., Ltd., Chrysell Road, London, S.W.9, for the Proprietors and Publishers, The Wireless Press, Ltd., 12-13, Henrietta Street, London, W.C.2; Sydney, N.S.W., 97, Clarence Street; Melbourne, 422-24, Little Collins Street; New York, 326, Broadway.



WIRELESS WORLD

AND

RADIO REVIEW

No. 175. [No. 12. VOL. XI.]

23rd DECEMBER, 1922.

Registered at the G.P.O. as a Weekly Newspaper.

BURNDEPT

WIRELESS APPARATUS

*The Ideal Receiver
for the Ideal Home*

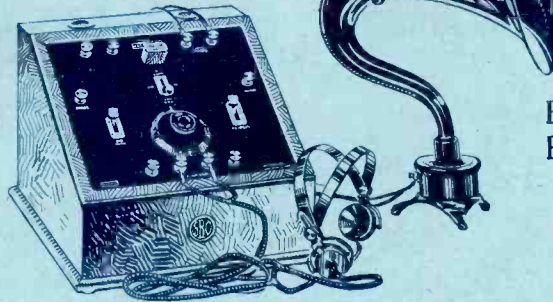

Ethophone III.
Broadcast
Receiver

34
GUINEAS.

All **BURNDEPT** Valve Apparatus is duly licensed under Marconi Patents for amateur use in Great Britain.

BURNDEPT LTD., 15, BEDFORD ST., STRAND, W.C.1

City Depot—79, Mark Lane, E.C.

London Assurance House,
Bond Place,
LEEDS.

93, Holm Street,
GLASGOW.

Bank Buildings,
Middle Street,
YEovil.

Aerial & Eastnor Works, Blackheath, S.E.3

Exchange Buildings,
133, New Street,
BIRMINGHAM.

91, Bridge Street,
MANCHESTER.

WESTON ELECTRICAL MEASURING INSTRUMENTS

THE WESTON MODEL 280 VOLT-AMMETER

Triple Range. 150/15/3 Volts. 15/1.5/0.15 amps.

This Precision Instrument is especially suitable for Wireless Research Work, i.e.

3 Volt Range.—Testing accumulator cells, dry batteries, measuring fall of potential across potentiometers.

15 Volt Range.—Testing 6 or 12 volt accumulator supplying voltage to valves, etc.

150 Volt Range.—Testing H.T. Batteries, etc.

0.15 Amp. Range (150 M.A.).—Measuring H.T. Current to transmitting valves, determining resistance of Transformers, chokes, telephones, rheostats, etc.

1.5 Amp. Range.—Adjusting filament currents, etc.

15 Amp. Range.—Measuring output or charging current of accumulators, etc.

NOTE.—The 3 volt range may be used as a sensitive low range Milli-Ammeter. SEVEN INSTRUMENTS IN ONE CASE.

PRICE £10. Leather Case 15/-

Write for further particulars.

WESTON ELECTRICAL INSTRUMENT CO., LTD.

Audrey House, Ely Place, Holborn, E.C.1

Telephone: Holborn 2029.

Telegrams: "Pivoted. Smith. London."

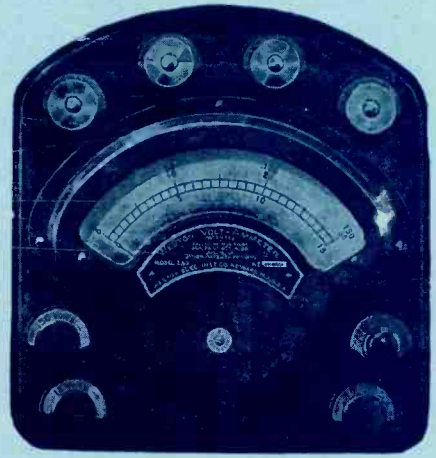

MODEL 280

The YEAR BOOK of WIRELESS Telegraphy and Telephony 1922

1476 Pages.

Price 15/- Nett.

Demy 8vo.

Postage Inland 1/-.

Abroad 1/4.

CONTENTS :-

Record of the Development of Wireless Telegraphy—National and International Wireless Laws and Regulations—Directory of the World's Land and Ship Wireless Stations—International Allocation of Call Letters—Alphabetical List of Call Letters—Meteorological Section—International Time and Weather Signals—National Résumés of Progress in Wireless Telegraphy—Particulars of Wireless Telegraph Patents, 1921—Aviation Section—Tabular List of Aviation Stations—Useful Data Section—Wireless Terminology—Conventional Signs used in Wireless Diagrams—Companies Engaged in the Commercial Development of Wireless Telegraphy—Biographical Section—Literature on Wireless Telegraphy and Telephony—Directory of the World's Wireless Societies—Directory of Wireless Colleges and Schools—List of Licensed Amateur Transmitting Stations—Code Section—Special Articles on "The Earthing Resistance of Antennae," by Dr. Miessner—"The Recording of Wireless Signals," by Dr. Abraham—"The Birth and History of Long Distance Wireless Telegraphy"—"The Rectification Effect in its Reaction to the Composition and Structure of Crystals."

A valuable feature of the present issue is the specially drawn map, which gives, for the first time, a simple means of finding the distance and true direction of Wireless Stations in all parts of the World, from London as the centre.

THE WIRELESS PRESS, LIMITED,

DEPT. W.W., 12-13 HENRIETTA ST., STRAND, LONDON. W.C.2



TYPE F. "Featherweight."
Actual weight, including cords,
is 6ozs. only.

BROWN'S



HEADPHONES

British and Best

The Finest Headphones Procurable for

30/-

This price is for one pair of either
120 or 4000 ohm 'phones, including
cords of good quality.

Catalogue Post Free.

Head Office and
Works:
Victoria Road,
North Acton, W.3

S. G. BROWN, Ltd.

London
Showrooms:
19 Mortimer St.,
London, W.1

Engrave this Official Sign



Every receiving set must now bear the
official mark.

All amplifiers, head receivers, loud speakers
and valves must also bear this mark.

We can supply Set Copy which, used
with the Taylor-Hobson Engraving Machine,
enables you to engrave this sign on your
apparatus cleanly, quickly and cheaply.

Write for fuller particulars.

TAYLOR, TAYLOR & HOBSON, LTD.

74a, Newman Street, London, W.1

Works: LEICESTER.

Ediswan Valves

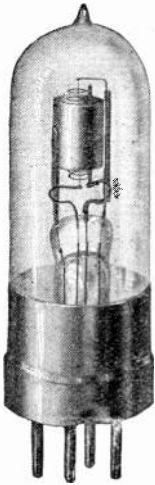

have over forty years' of lamp making experience embodied in their manufacture. The AR Valve illustrated is specially made for amateur reception.

Plate voltage 30-80. Filament volts 3.5-6.0. Filament current 0.75 amperes. High amplification. Silent working.

15/- each

THE EDISON SWAN ELECTRIC Co., Ltd.

Head Office: 123/5 Queen Victoria Street, E.C.4

London Showrooms: 123/5, QUEEN VICTORIA ST., E.C.4
71, VICTORIA ST., S.W.1

Works: PONDERS END, MIDDLESEX

BRANCHES:—

Aberdeen	Bristol	Edinburgh	Leicester	Nottingham
Belfast	Cardiff	Glasgow	Liverpool	Sheffield
Birmingham	Dublin	Hull	Manchester	Southampton
Brighton	Dundee	Leeds	Newcastle	Swansea
Melbourne		Brisbane	Sydney	Adelaide

If you are unable to obtain Ediswan supplies from your usual dealer, write to us for the name and address of the nearest supplier.

EDISWAN BATTERIES H.T. and L.T.

are all manufactured with the same care and attention to details as other Ediswan products. Always insist on "Ediswan" when purchasing Accumulators or Dry Batteries.

HOP
134

IMPORTANT.

HOP
134

WE HAVE OPENED VERY COMMODIOUS PREMISES AT

54 GRACECHURCH STREET, E.C.3

for the demonstration and sale of all types of Wireless Receiving Sets and "Claritone" Loud Speakers. Amateurs and Experimenters will be able to obtain every part required for any type of Set including:—

Transformers, L.F. and H.F. Headphones, all types, all resistances.
Condensers, Variable and Fixed, all capacities.
Vario-Couplers and Vareometers. Coil Holders and Coils.
Anti-Capacity Switches, all types.
Rheostats, all types.
Radial Switches, 5, 10 and 15-way.
Valves, M.O. and Mullards.
Ebonite Valve Holders, Dials, Scales, other parts and in Sheet.

Brass W.O. and Telephone type Terminals, Nuts, Washers, Contact Studs and all other parts.

Accumulators.

Dry Batteries.

Aerial Wire.

Insulators.

Hertzite and Galena Crystals.

Cotton and other Tubings, all colours.

Etc. etc.

PRICE LIST ON APPLICATION.

Pettigrew & Merriman, Ltd., 122-124 Tooley St., London, S.E.1

NOTE.—54, Gracechurch Street, is a few yards from Monument, Eastcheap, Bank, Cannon Street and London Bridge.

TO TEST YOUR HIGH TENSION BATTERY YOU MUST USE A HIGH RESISTANCE VOLTMETER

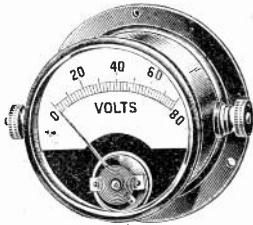

Moving Coil Type
2½ inch dial

We have designed a suitable instrument, to read to 80 volts.

Can be supplied in polished brass or nickelled case

Price 45/6 each

POST FREE. CASH WITH ORDER

WHITE ELECTRICAL INSTRUMENT CO. LTD.

2, 4 and 6, Gloucester Street, Clerkenwell, London, E.C.1

Telegrams : *Voltograph, London.*

Phone : City 8660.

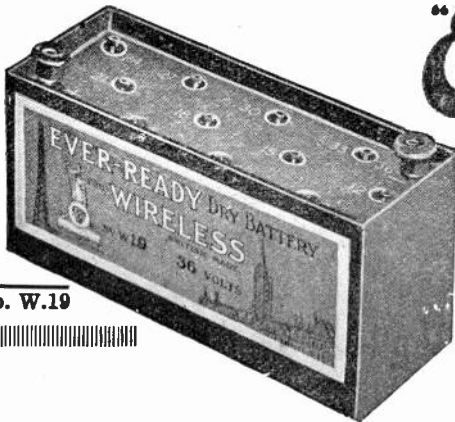

No. W.19

Ever-Ready
British Made

DRY CELLS and BATTERIES

for High & Low Tension

THE STANDARD OF QUALITY



UW.1

HIGH TENSION BATTERIES

Any size or voltage with any tappings or sockets at 3 or 6 volt intervals for use with Wander Plugs can be supplied to order
With 13 sockets as illustrated.

No. W.19, 36 volts, 24 cells, 8/6 each. Size 6½ × 2½ × 3½.
Weight 2 lb. 8 oss.

Wander Plugs 1/- per pair. With 2 Spring Contacts.

No. W.11, 15 volts, 11 cells, 3/6 each. Size 9½ × 1 × 2½.
Weight 1 lb. 2 oss.

THE UNIT DRY CELL

"Build up your batteries as you build up your Marconi Sets."

Unlimited flexibility in size, voltage and intermediate tappings. Each cell is fitted with brass screw terminal and looped wire, and they are efficiently insulated to prevent current leak.

No. UW. 1, 7/6 per dozen. E.M.F. 1½ volts.
Weight 3¼ oss. Dimensions 2½ × 1 5/16 diam.

Art Catalogue of Standard Sizes and Voltages and list of Accumulators for Valve Filament Supply sent on request. Dept. D.L.

THE EVER-READY WORKS, Hercules Place, Holloway, N. 7.

DUTCH CONCERTS

ON A
HOME MADE
2 VALVE SET
THIS IS WHAT

CONQUEST

OFFERS YOU
IN THE JANUARY ISSUE.

Price 1/- net. Post free 1/3

Full working details with "fool proof" diagrams and illustrations of how to make this set are given.

Granted that it's not the smartest looking set made, but it works, and works well, too.

This is not a theoretical set; it's practical; it's been tried and proved to be

AN ABSOLUTE SUCCESS

This one constructional article alone is worth more than the shilling charged for the magazine.

Get the January number which will be published on December 20th.

IT WILL PAY YOU

CONQUEST

The Magazine of Popular Science,
12/13 Henrietta Street, London, W.C.2

NOW READY

BINDING CASES VOL. X.

The
**Wireless World
& Radio Review**
(INCLUDING INDEX)

Price **2/6** nett.

(Post free 2/11.)

INDEX (IF PURCHASED SEPARATELY)

Price **8d.** Post free.

A limited number only of
COMPLETE BOUND VOL. X
(April—September, 1922)

Price **25/-** nett.

(Post free 26/-)

For the benefit of those of our readers who desire to have their parts bound, we shall be glad to undertake this for them upon receipt of the copies and remittance of 8/6 which includes cost of Binding Case, Index and return postage.

The WIRELESS PRESS Ltd.
12-13, Henrietta St., London, W.C.2



1923
DIARIES

Let your 1923 Diary be a
Wireless one.

The Amateurs'
Diary and Notebook

Consisting of Charles Letts & Co.'s standard diary, with the addition of a section giving useful Circuits and Diagrams, List of Chief Regular Transmissions, Memoranda Pages for recording new call signals, and general data of value to Wireless Experimenters and "Listeners-in."

The Diary is encased in pig-skin grained "slip-in" covers with pockets for cards, stamps, etc.

Price **2/6** Complete. Post free **2/9**

The Wireless Press, Ltd.
12-13 Henrietta St., London, W.C.2

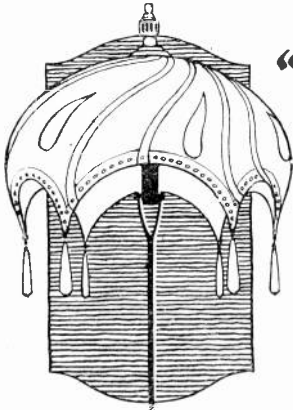

“Better than a frame aerial”

The “Ducon”

If you have electric light, the “DUCON” gives you all the advantages of a frame aerial, such as neatness, compactness, no outside aerial and far better results. All you have to do is to plug the “DUCON” into a lampholder or wall socket and connect to your wireless set.

**For all electric light circuits,
the “DUCON” ... 10/- each**

of all leading wireless dealers, electrical contractors and stores, or direct from the makers.

Dealers not yet stocking should write for trade terms.

Over 50,000 in use.

The DUBILIER CONDENSER CO. (1921) Ltd.

Ducon Works, Goldhawk Road,
Shepherd's Bush, London, W.12

Telephone : : Hammersmith 1084.
Telegrams : “Hivolcon, Phone, London.”

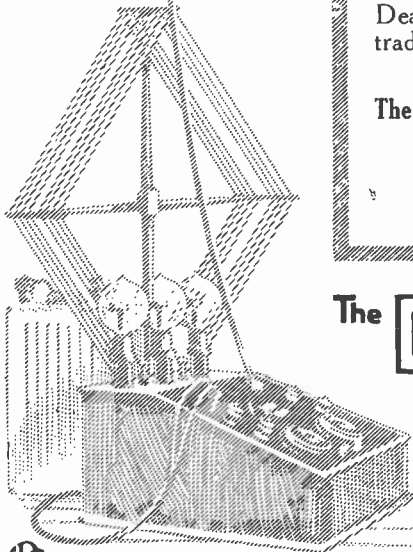

The DUCON



FOR USE WITH ANY SET

8

Wireless Made Easy

with the

JOYPHONE

2 - VALVE
Receiving
Set

COMPLETE

Price

£15

No Extras
Whatever

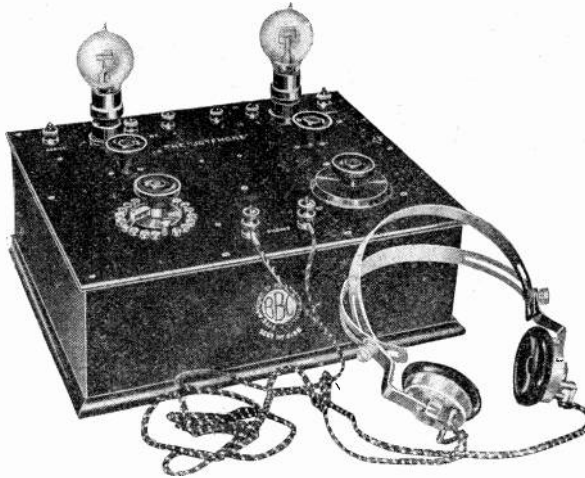

PRICE INCLUDES



Batteries
Accumulators
Aerial Wires
Aerial Insulators
Leading-in Tubes
2 Marconi "R"
Valves, 1 pair
4,000 ohm Head-
phones, and all
necessary
accessories

Nothing Extra
To Buy

(G.P.O. Reg. No. 0138).

The JOYPHONE 2-Valve Set *complete* has been specially designed for the reception of broadcasting in general. It is the result of long and careful experiment on the part of highly skilled experts, and embodies the finest British workmanship and materials. (Approved by the Postmaster-General.) The Joyphone is thoroughly tested, remarkably efficient and so simple that a child can operate it.

INSTALL A JOYPHONE in your home and every evening enjoy the broadcasting concerts and hear the latest news.

We can give immediate delivery and can arrange to fix the Joyphone within the London area.

This is a *complete set* ; no further accessories are required, and no additional expense necessary.

Install a Joyphone in Your Home

All valves apparatus duly licensed under Marconi patents for Amateur use in Great Britain. Approved by Postmaster-General.

You are cordially invited to call any evening and hear the daily broadcasting received to perfection on the JOYPHONE.

The BRITISH JOYPHONE CO.

614, Old Ford Road, Bow, London, E.3

Telephone :
East 3345.

Near Old Ford
Station, N.L.Ry.

No. 8 or 39 'Bus
brings you to the door.

BROAD

HIGH POW

All our Broadcasting

REMEMBER THIS WHEN
BROADCASTING

ALL BEAR BRO

Made under
High Frequency Amplifi-

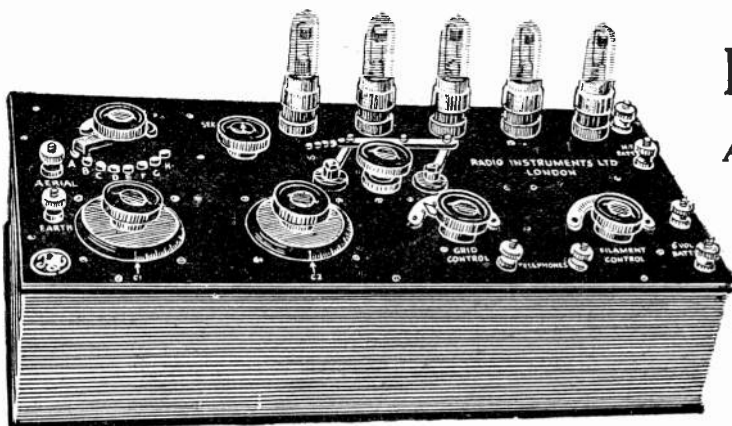

5-VALVE SET.
Price £40.
Price, without
accessories, £32.
P.O. Registered
No. 1108.

A visit to our Show-rooms will convince you that R.I. Sets are the finest on the British market.

IMMEDIATE

The most experienced designers of High Power Receivers in the world.

Our latest attractive Show-receipt of

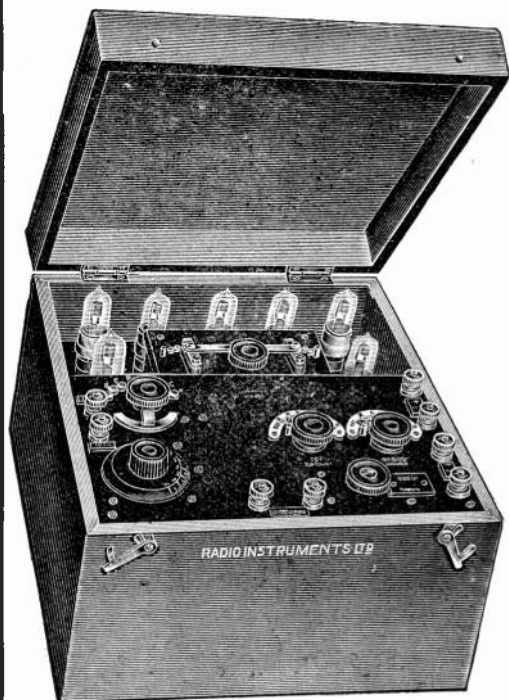

7-VALVE SET
Price, complete
with all acces-
sories . . . £75
Price of Instru-
ment alone, £66.
Valves Extra.
P.O. Registered
No. 0140

RADIO INSTRU

Managing
J. Joseph, M.I.E.E. late, *Mana'er*
Chief
W. A. Appleton, M.B.E., M.I.R.E., late
Research

ONLY ADDRESS: Works,
12a, Hyde Street, NEW OX

Telephone—Regent 1908.

CASTING ER MODELS

Models 300-4000 Metres

COMPARING WITH OTHER SETS.

ADCASTING SEAL

Marconi Licence.
ation on all Sets.

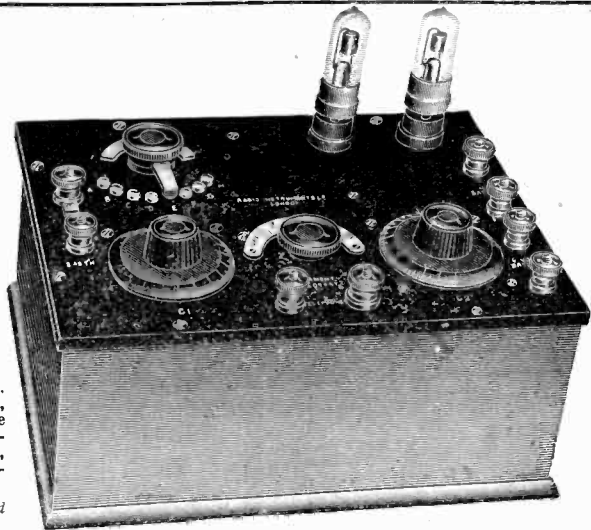

2-VALVE SET.
Price, complete, £23 15s. Valve Amplifying Receiver alone, without Accessories, £18 5s.
P.O. Registered No. 2003.

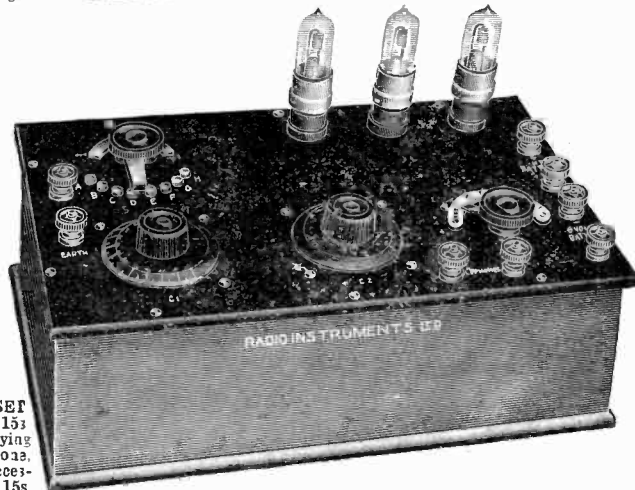

3-VALVE SET
Price £30 15s. Valve Amplifying Receiver alone, without Accessories, £23 15s.
P.O. Registered No. 0109.

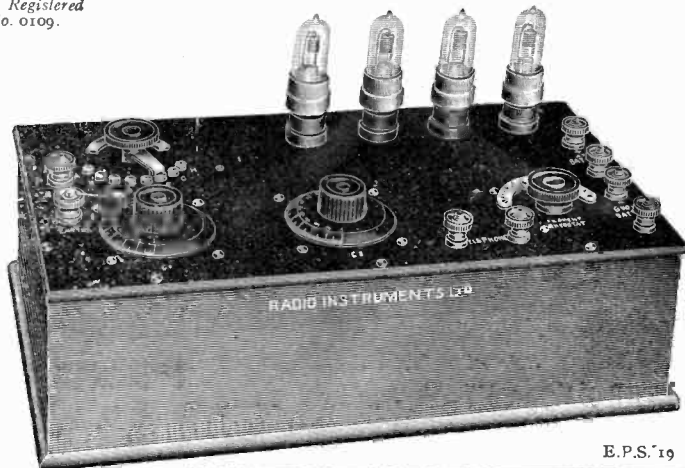

4-VALVE SET.
Price £33 10s. Valve Amplifying Receiver alone, without Accessories, £27 5s.
P.O. Registered No. 0112.

Our own Engineers will demonstrate these instruments. Everything up-to-date is here shown, and demonstrations given of every type of Loud Speaker on the market.

DELIVERY

Write for illustrated Brochure containing full particulars of cabinet models.

card will be sent free upon post card.

MENTS LTD.

Director :
to Mr. H. W. Sullivan.

Designer :
Admiralty Technical Officer.

Offices and Showrooms :
FORD ST., W.C.1

Telegrams—Instradio, London.

Dry Batteries for Wireless Sets

No. 1 W. Standard Pocket-lamp size, 4½ volts (as illustration), with patent spiral wire terminals for connecting in series.

Insert straight terminal in spiral of next battery and bend same, no soldering required.

PRICE 7/- Per doz.

NOTE.—(1 doz.=54 volts).

NEW TYPE.
No. 2 W. Slab-
15 volts, 1 screw
terminal, 5 plug
sockets, 3-volt
tappings with
wander plug.
Size
9" x 1½" x 2½"
high.

PRICE
3/-
EACH

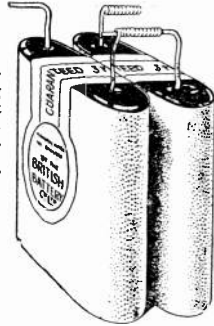

NEW TYPE.
No. 4 W.
36 volts, 1
screw terminal,
12 plug sockets,
3-volt tappings
with wander
plug. Size
9½" x 1½" x 2½"
high.

PRICE
7/-
EACH

No. 1 W.
Connect as illustration.
(Patent applied for).

BRITISH MADE—CARRIAGE PAID.

Manufactured by—
THE BRITISH BATTERY Co., Ltd.
Clarendon Rd., WATFORD, HERTS.
(Telephone: Watford 617.)

FOR WIRELESS INSULATION

USE
"BAKELITE"
(Trade "FORMITE" Mark)
Insulating Material



Sole Manufacturers—
THE DAMARD LACQUER CO., LTD.,
Warwick Rd., Greet, Birmingham

BROADCASTING

You cannot beat this

B.R.C. 1 Crystal Receiving Sets, specially designed by an ex-Marconi Engineer and Chief Inspector to Government Telegraphs, 19 years experience. It comprises Brown's Headphones 4,000 Ohms, Sliding Inductance Range up to 3,000 Metres, fixed Condenser with Mica Dielectric, Variable Condenser, ¼" Ebonite Panel, Crystal Detector, Universal Ball and Socket Adjustment, Complete Aerial and Earth Equipment.

The set is compact, portable and enclosed in a polished oak case. It will receive Telephony up to 25 miles and Paris Time Signals and other principal stations. No batteries required. Approved by P.M.G. Reg. No. 207.

Price including the Broadcasting Fee
£4 10s. 0d. complete.

Demonstrations given any evening on this or our Valve Sets.

**THE BIRMINGHAM
RADIO COMPANY**
Carlton House, BIRMINGHAM

Telephone: Central 6025.

THE MARK OF RELIABILITY

Filament Resistances

2/-

EACH

Panel Type with Knob and Pointer

Potentiometer 300 ohms

4/6

EACH

Panel Type on Ebonite



1 to 12 Volts.

1 to 35 amps.

VOLT & AMMETER

Combined Dead Beat Pocket Type. New and not German. Splendid Instrument in Nickel Plated Case. Ideal for Testing Cells and Filament Current.

POST PAID **5/6** NUMBER LIMITED

OTHER EXCEPTIONAL VALUES

Aerial Wire. Bright Hard Drawn, 7/22 Copper, 3/6 per 100'; same enamelled, 5/-.

Aerial Insulators. 2 x 2½", Shell type, 9d. each; 2" Reel Type, 2d. each.

Telephone Transformers. (Army Type.) 9/- each; L.F. Transformers, 15/- each.

Vernier Condenser. 5-Plate for Panel mounting, 4/- each. -001-58 Plate, 18/-.

Wireless Jacks, with Plugs, 1/- the pair.

High Note Buzzer (Army Type), Worth treble, 3/- each; Tapping Keys, 5/6 each.

Dewar Switches. D.P. Change-over, panel type, 2/- each. Small Switch Arms, 6d. each.

Write for "Complete Supplementary Price List of Exceptional Values," sent Post Free.

All goods sent CARRIAGE PAID, but with orders under 5/6 add 6d. for postage.

J. H. Taylor & Co. Electrical & Radio Engineers.
Macaulay St., Huddersfield.
Telephone: 341. Telegrams: "Thorough," Huddersfield.

Wireless for Christmas



Ideal Christmas Entertainment.

FOR OLD AND YOUNG.

--- Listen to Broadcast Concerts on Winter Evenings.

BRING your children to hear our demonstrations between 6 p.m. and 10 p.m. any evening. In our showrooms you have your choice of Wireless Receivers made by all the leading British manufacturers :

CRYSTAL SETS	-	-	from	£2 2 0
SINGLE VALVE SETS	-	„	7 7 0	
MULTI VALVE SETS	-	„	15 15 0	

(All complete and ready for immediate use)

WIRELESS SERVICE, LIMITED

2, LOWER JOHN ST., PICCADILLY CIRCUS, W.1

Near Regent Palace Hotel.

“RADIO-WAVE” CRYSTAL BROADCAST RECEIVER.

This Broadcast Receiver conforms to the Post Office Regulations for Broadcast Receiving apparatus. There are many receivers being offered to the public which do not conform to these requirements and broadcast licence holders may later experience the annoyance of having them condemned by the Post Office Inspectors. Apart from this there are other reasons why you should not hesitate to fix your choice on the “Radio Wave” Crystal Broadcast Receiver.

- (1) You will not be confined to the reception of Broadcast. Amateur telephony and morse code messages from ships may be tuned in.
- (2) The short wave switch gives **ULTRA EFFICIENCY** on amateur wavelengths.
- (3) The twelve-point inductance switch gives 100 per cent. tuning accuracy. The instrument is therefore extremely **SENSITIVE** to the **WEAKEST OF SIGNALS**.
- (4) Only selected Hertzite crystals are used in the detector.
- (5) The detector is robust, comfortable to handle, and easy to adjust, giving every possible point of contact.
- (6) The detector cup may be easily removed—facilitating rapid replacements.
- (7) Owing to the special care taken in the construction to avoid electrical leakage this instrument should give a slightly larger signal range than the average crystal receiver.
- (8) It is a well made handsome apparatus, metal parts being highly polished and lacquered, and the cabinet work French polished mahogany.
- (9) It is sent out with full instructions, under guarantee.

Price, including cost of aerial wire, insulators, 4,000 ohms resistance headphones, with two earpieces **£10 10.**

MADE BY:

THE MEDICAL SUPPLY ASSOCIATION, Ltd.
167/185 Gray's Inn Road, London, W.C.1. Works: London & Sheffield.

Telephones: MUSEUM 7210, 7211, 7212.

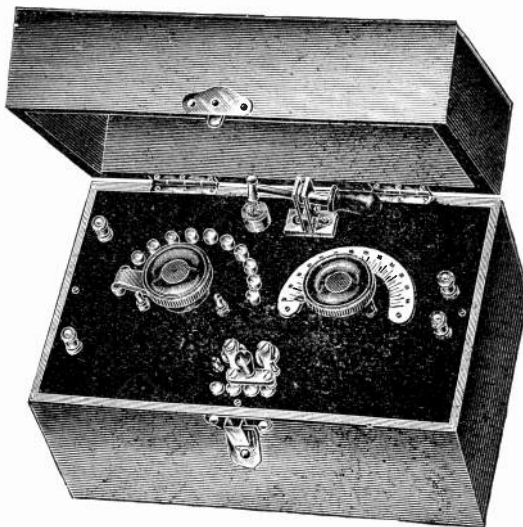

RADION

MAHOGANITE

This is the latest product of our Factories— a superior insulating material for high grade sets, which in grain and colour closely resembles mahogany. Its high insulating and non-warping properties, combined with a beautiful finish, make it an ideal material for Panels.

The Trade are warned against imitations— ordinary mottled Ebonite is *NOT* RADION - MAHOGANITE. All genuine Sheets are stamped "RADION". Enquiries from bona-fide Manufacturers and Wireless Dealers solicited.

AMERICAN HARD RUBBER COMPANY (Britain) LIMITED,
13a, Fore Street, London, E.C.2

TELEPHONE—12754 CENTRAL.

"OOJAH" BASKET INDUCTANCES

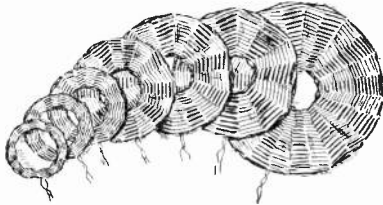

We have pleasure in announcing that owing to the reduction in the price of wire and greatly increased output we are able to lower the price of OOJAH BASKET INDUCTANCES to

PER **5/-** SET

Postage 4d.

LIBERAL DISCOUNT TO FACTORS.

All "OOJAH" Inductances are wrapped in a transparent covering and sealed with the Registered Trade Mark "OOJAH."

The Seal is a guarantee of quality. None are genuine without.

"OOJAH" Basket and Slab Inductances are being extensively copied, as most good things are, and purchasers are advised to not only specify "OOJAH" Brand in their order, but to see that the seal is intact.

GREENSLADE & BROWN
LANSDOWNE ROAD, CLAPHAM, S.W.9

Telephone—BRIXTON 639 & 3251.

GENTS' "TANGENT" FILAMENT RHEOSTAT

STURDY, SOUND & RELIABLE



SEND FOR LATEST PRICES OF—
GENTS' "TANGENT" FILAMENT RHEOSTAT
GENTS' "TANGENT" L.F. TRANSFORMER
GENTS' "DISCOL" H.F. TRANSFORMER
and other Fittings.

GENT & CO., LTD. Radio Dept., Paraday Wks., **LEICESTER**

LONDON: 25, Victoria Street, S.W.1.
NEWCASTLE-ON-TYNE: Tangent House, Blackett Street.

GENUINE HELLESEN DRY BATTERIES

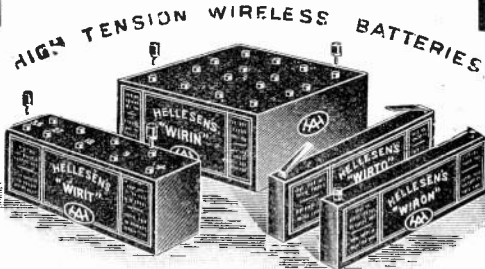

SPECIAL TRADE AND WHOLESALE TERMS

Code word	Volts.	Details.	Price.
"WIRON"	15	Screw terminals	4/- each
"WIRTO"	15	Strip	4/- "
"WIRIN"	30	2 insulated winder plugs	8/8 "
"WIRIN"	60	2 "	14/- "

Winder Plugs and Terminals are included in the price of the Battery and are NOT AN EXTRA.

KNOWN THE WORLD OVER AS THE BEST.

ALL LISTS FREE ON APPLICATION.

A. H. HUNT, LTD.
H.A.H. Works, Tunstall Rd., Croydon, Surrey

Crystal of To-
day and Future

THE GREAT
"HERTZITE"

Price 2/6 post free
With Ball and
Socket Detector 5/6

VALVES :—" C.V.C.," " ORA," " XTRAUDION," " R.M.R." 15/- each.

RUSSELL & SHAW, 38, Great James Street, Bedford Row, W.C. 1

THE WIRELESS WORLD AND RADIO REVIEW

THE OFFICIAL ORGAN OF THE RADIO SOCIETY OF GREAT BRITAIN
A MAGAZINE DEVOTED TO WIRELESS TELEGRAPHY AND TELEPHONY

CONTENTS

The London Station of the British Broadcasting Company. By R. H. White	- - -	389
A Multilayer Inductance Coil. By C. E. Wheeler	- - - - -	392
Concerning an Experimental Licence	- - - - -	394
Electrons, Electric Waves, and Wireless Telephony. By Dr. J. A. Fleming, F.R.S.	- - -	396
Distributing Problems of Radio Manufacturers. By M. B. Sleeper	- - -	401

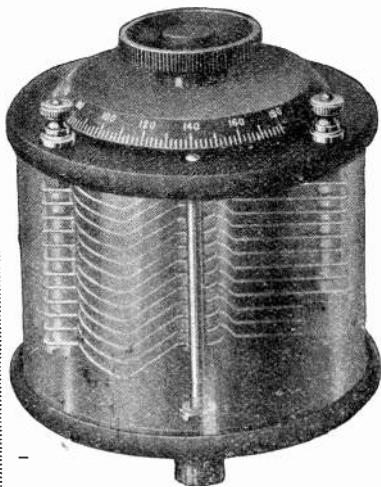

TYPE A.1 Cap. '0005

SPECIFICATION.
Rotary, Air Dielectric, 22 Gauge Aluminium Vanes. Metal to Metal Adjustable Bearings. Contact to moving vanes by copper strip. Spacing between plates sufficient for pressure up to 1000 volts. Built upon Ebonite circular panels. Best Ebonite insulation throughout. Transparent Celluloid dust proof case. Engraved Ebonite Dial.

All Standard Capacities supplied.

PRECISION VARIABLE CONDENSERS

A few points of interest
to Retail Traders.

FALLON Condensers are built up to a standard—not down to a price. The Condenser we illustrate is the Condenser we sell you. Delivery always on time. Trade terms, which are liberal, will be quoted upon application. Colonial orders through British Shippers also receive prompt attention.

Fallon Condenser Manufacturing Co.
230a, Hermitage Road, LONDON, N.

STALLOY	TRANSFORMER LAMINATIONS
	SOLE MANUFACTURERS AND SUPPLIERS JOSEPH SANKEY & SONS LTD
	WORKS: BILSTON, STAFFS. London Office: 168 RECENT ST. W.I.
	TELEPHONE RECEIVER DIAPHRAGMS

CONTENTS *(Continued)*

Experimental Station Design. By F. H. H.	403
Wireless Club Reports	407
Notes	412
Correspondence	413
Calendar of Current Events	414
The Transatlantic Tests	415
Questions and Answers	416
Share Market Report	420

THE WIRELESS WORLD AND RADIO REVIEW is published weekly on Saturdays.

All correspondence relating to contributions should be addressed to THE EDITOR, THE WIRELESS WORLD AND RADIO REVIEW, 12-13, Henrietta Street, Strand, London, W.C.2.

No responsibility can be taken for MSS. or photographs sent without stamps to defray cost of return postage.

Editorial and Publishing Offices 12-13, Henrietta Street, Strand, London, W.C.2.

Telegraphic Address: "Radionic, Rand, London." Telephone No.: Gerrard 2807.

Advertisement Managers, Bertram Day & Co., Ltd., 9 and 10, Charing Cross, S.W.1.

Telephone No.: Gerrard 8063 and 8064

SUBSCRIPTION RATES.

28s. per annum, post free. Single Copies 6d., or post free 7d.

Registered at the G.P.O. for transmission by Magazine Post to Canada and Newfoundland.



We are almost ready to supply receiving sets conforming in every way with the latest instructions of the Postmaster-General as related to Broadcasting.

Write u now concerning your particular requirements; no obligation will be incurred by your so doing. There are no regulations to prevent the sale of our component parts, of which we supply a very large number. Advice and assistance freely given. Write or call and see us. Demonstrations daily.

Offices and Showrooms:

Phone **110, STRAND, LONDON, W.C.2** Phone
8806 Gerrard. 8806 Gerrard.

To the
Discriminating
Experimenter.

A New Filament Resistance

Holders of experimental licences who make their own apparatus are naturally anxious to obtain the highest possible efficiency in every component part. To meet the requirements of the discriminating experimenter the Marconi Scientific Instrument Company, Ltd., are now selling a line of high-grade component parts of the same quality as those used in their own justly famed "Units." As an example, the Marconi filament rheostat illustrated herewith possesses a number of features which make it unique.

Firstly, the resistance wire is heavy enough to carry current for three valves, if necessary, without overheating. The wire itself is wound on a grooved former. Contact is made by a heavy copper spiral which, when rotated by the knurled ebonite knob, moves smoothly from one end of the coil to the other. There are no "jumpy" places, no jolts and jars, and the movement throughout is as smooth as that of a good variable condenser. Contact between the former and the spiral is maintained by the spring shown.

This resistance is supplied ready for panel mounting with high-grade ebonite knob and pointer, together with fixing screws. Mounting is effected by drilling a central hole $\frac{3}{8}$ ths diameter, and three clearance holes for 4 B.A. metal screws. The brass support is supplied already threaded for these screws.

The price—12/6—is very reasonable compared with that charged for the ordinary type of rheostat. A potentiometer wound on the same principle is sold for 15/-, the resistance being 300 ohms.

*The Marconi Scientific Instrument Co. Ltd.
The House for the Discriminating Experimenter.*

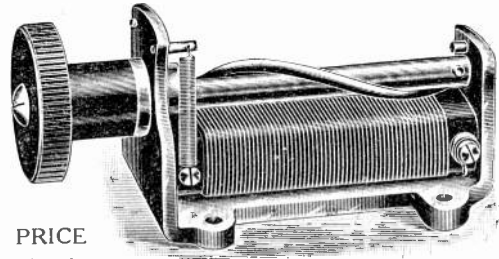

PRICE
12/6

Special Holders for V24 and QX Type Valves

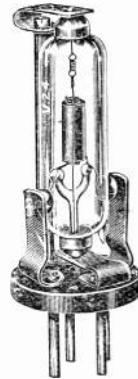

Type D.
PRICE
4/-

Many experimenters are anxious to try the V24 and QX valves in their own receivers. These valves are of tubular form, and are mounted in a manner different from that of the ordinary "four-pin" types. Both valves oscillate very readily on low anode voltages, and the former is very popular for separate oscillators. Both QX and V24 valves have a very low self capacity, and are therefore useful in short wave reception. The Marconi Scientific Instrument Company, Ltd., is now marketing adaptors which will enable these valves to be used in any four-pin socket. They are particularly recommended to those who have constructed heterodynes for either short or long wave work, as they enable very low anode voltages to be used.

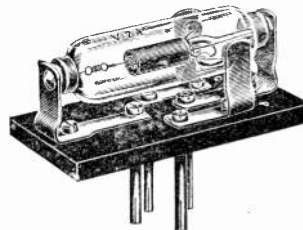

Type E. PRICE 3/6

Are you making wireless gifts for Christmas? Call at our Dean Street Show-rooms, and see the full range of components and complete sets.

The Marconi Scientific Instrument Co. Ltd.

Telegrams : Themasinco, Westcent. 40 Dean Street, Soho, W.1 Telephone : Gerrard 7745.

How did YOU receive the Election Results?

It can be confidently said that all who were listening in with a Wates Set were very pleased with the reception when the election results were broadcasted.

The reception was good—not only because Wates Sets are perfect in manufacture, but also because purchasers can avail themselves of the free advice of our technical experts, who can help them to get the best possible results under varying circumstances.

Not only do we manufacture complete Receiving Sets of the best quality, but also all component parts.

The illustration is that of the PYRAMID H.T. Battery, which we can confidently recommend to help you to get better results. It is priced as follows.—

Filament Resistances	3/9
“Ideal” Valve Accumulator—	
4-Volt 50 amp. -	25/-
(Carriage 2/-)	
6 „ 50 amp. -	35/-
(Carriage 3/-)	
Variable Condensers (of various capacities)	
From	6/-
Fixed Condensers. From	2/6
3-Coil Holder, complete Unit for use with Standard Coils - -	20/-

15-Volt 3/6

30-Volt 7/6

With variable plug connection.

Send 3d. stamps for our Illustrated Catalogue.

List of H.T. Batteries or Accessories—Free.

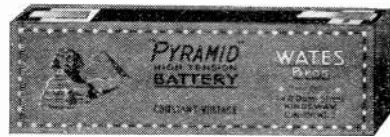

WATES BROS., 13-14, Gt. Queen St., KINGSWAY, LONDON, W.C.2

J. BURNS, LTD. Wangye Works, Chadwell Heath, Essex.

We are actual manufacturers and can offer special advantages to the trade—send us your enquiries.

	Retail price
CONDENSERS.	
001 mid.	13/6 ea.
0005 „	10/- ea.
0003 „	9/- ea.
00005 „	4/6 ea.
Filament Resistances.	
Terminals with high base	1/6 doz.
Contact Studs, with nuts	9d. doz.
Sliders, with springs and studs	9d. ea.
Ebonite Panels, cut to order	3/6 lb.
Ebonite Coil Holders	12/6 ea.
Ebonite Knobs	4/- doz.

Single Valve Panels

fitted with Variable Condenser, Filament Resistance, Grid Leak and fixed Condenser, Engraved Panel and Rosewood finished Box, ready for use - -

£ 4

Vulcanised Fibre and Ebonite Sheets, Rods & Tubes from stock.

WIRELESS PARTS

AND ACCESSORIES AT MANUFACTURERS' PRICES

Aerial Wire, 100', drawn copper, 7/22's	3/6
Aerial Wire, 100', drawn copper, 7/22's, enamelled	5/9
Brass Rod, Square, 13"	6d.
Condenser Vanes, guaranteed accurate per doz.	9d.
Contact Studs. per doz.	1/-
Crystal Detector. New Design. Mounted on ebonite base, universal joint, ebonite handle, heavy brass terminals, without crystal	3/4
Cabinet, 14 1/2" x 12", for sloping panel, beautifully polished and finished each	19/-
Fixed Grid Condensers each	1/6
Slide and Plunger per doz.	7/6
Porcelain Insulators each	6d.
Terminals. Solid brass, knurled, large, 2/- doz. ; 21/- gross.	
Terminals. Solid brass, knurled, small, 1/5 doz. ; 15/- gross.	
Please include enough for postage. Orders over 20/- carriage paid.	

HANDY BENCH VICE, specially suited for the Wireless Workshop, 2" jaw, all steel, Sheffield make. For a short period only. Carriage paid 8/11

Let us quote you for best quality wireless component of every description. Every article guaranteed, money returned if not satisfied.

Special terms to the trade.

The “Abro” Motor Co.,

Wireless Dept.,

184 & 186, London Road, Manchester.

Works : 73 & 75, Downing Street and Hague Street.
Phone—Central 6142.

THE WIRELESS WORLD AND RADIO REVIEW

THE OFFICIAL ORGAN OF THE RADIO SOCIETY OF GT. BRITAIN

No. 175 [No. 12. VOL. XI.] DECEMBER 23RD, 1922.

WEEKLY

The London Station of the British Broadcasting Company.

By R. H. WHITE.

POWER is derived from the Electric Supply Co.'s mains, which in this case is at a pressure of 200 volts D.C. Arrangements are made so that the supply may be changed over from the ordinary supply network, to the London theatre supply main, thus being assured of two separate and distinct sources. The direct current is taken through

a switchboard and so to a 10 H.P. direct current motor which is directly coupled to a 6 kW. single phase, 300 cycle alternator. This alternator supplies power at 500 volts A.C., thus providing an ample margin for any increase in power which may be authorised at a later date, the present power being $1\frac{1}{2}$ kW. to the oscillation valve. The

motor alternator sets are also in duplicate, and are arranged so that a single throw-over switch disconnects one set and connects the other. Arranged on the wall above these sets are two remote control automatic starters which are operated from the wireless room at the top of the building. The alternating current from these sets is taken by cable to the top of the building, where it is supplied to the primary of a 6 kW.

transformer, which again has a second transformer installed beside it with a change over switch so that either transformer may be used. The secondary windings of these transformers gives a normal working potential of 22,500 volts, and they are connected to a high tension link board so that either transformer may be connected to the wireless transmitter.

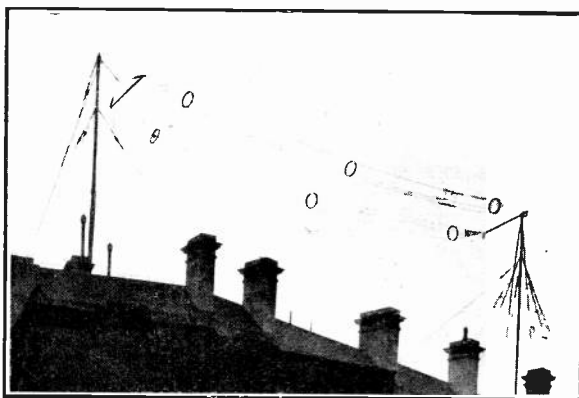

The Aerial of the London Broadcasting Station (2 LO).

We now come to the actual wireless transmitter, which consists of four separate panels as shown in the photograph. Each panel is mounted in a frame entirely enclosed in plate glass or metal, so that all the apparatus mounted within the frame is thoroughly protected from dust. Special ventilation is provided for the valves and

this protection also prevents the danger of electrical shock to persons having access to the wireless room.

The first of these panels is for accommodating the rectifying apparatus, and its function is to convert the alternating current into direct current at a pressure of approximately 10,000 volts.

The method by which this function is performed is that now common to wireless practice

and is attained by the use of two thermionic rectifying valves. The filaments of these valves are lighted from a highly insulated transformer, the primary of which is connected to the 500 volt alternating current supply through a variable inductance, and also through a compensating inductance. The function of the former is to regulate the filament voltage, whilst that of the latter is to compensate for line drop when the power load is thrown on to the line. This is accomplished by means of an automatic switch which short circuits the compensating inductance the moment the load is switched on. The secondary winding of each power transformer has a central connection which is joined to the earth of the wireless system. The two ends of the secondary winding are joined to the anodes of the two rectifying valves. The filaments of these two valves become the positive high tension direct current pole of the wireless circuit.

As soon as the alternating voltage is applied to the rectifier lighting transformer the filaments are lighted and the alternating current is applied to the rectifier anodes. The current will pass through the rectifying valves in one direction only, alternating first through one and then through the other at the frequency of the alternator, *i.e.*, 300 times per second through each valve, and in such a manner that both sides of the alternating wave are rectified, so that we have a unidirectional current having a ripple on it of 600 per second. This current is then applied to the smoothing or filtering system, which consists of a large condenser connected between the earth and the positive direct current pole. This condenser tends to smooth out the ripple which is on the top of the direct current. The current after passing through this condenser has to flow through a large iron-cored inductance, and so to a second smoothing condenser of a similar capacity to the former. By the time the current leaves the second condenser it is to all intents and purposes a smooth direct current, and is in fact, far smoother than the current which would be obtained from a direct current generator, as such current has always a certain amount of ripple caused by commutation and also an irregularity caused by slight brush-sparking. Directly connected across the last condenser is a very high resistance with a voltmeter in series with it. This voltmeter serves two purposes—firstly it measures direct current voltage and secondly it

automatically discharges the condensers after the current has been interrupted. This prevents danger from shock which would occur if this leak were not connected. The high tension direct current passes through a milliammeter and so to the second panel.

The second panel consists of an oscillatory circuit which in this instance is called the drive oscillator. The circuit is one which is common to most wireless transmitters and consists of a closed circuit composed of an inductance and condenser, one end of the inductance and one end of condenser being connected to earth, whilst the high potential end of the condenser is connected to the anode of the oscillating valve, and the grid of the same valve is inductively coupled to the same inductance. The grid is also connected to earth through a high resistance across which is a small condenser. The anode of this valve is fed from the positive high tension direct current, from the positive busbar through a milliammeter, whilst the valve filament is connected—one end to the negative earth busbar and the other through a variable resistance to the positive low tension busbar. These two busbars, *i.e.*, positive and negative low tension, are continuous throughout the drive panel as well as the amplifier panel, which we are about to consider, and the modulator panel. They are connected by means of a switchboard to a low tension accumulator battery of 40 volts and 330 ampere hour capacity.

The next panel to be considered is the amplifier panel, and this panel is in many respects identical with the drive panel. In it are mounted a closed oscillating circuit consisting of an inductance and capacity, one end of the condenser and one end of the inductance being connected to the earth busbar as in the drive panel. Connected to the high potential end of the inductance is the anode of the second valve which in its turn is again fed from the high tension busbar, whilst its grid is connected back to the drive panel, and is there taken through an inductance which is coupled to the oscillating circuit of that panel. At the same time this grid is connected to another inductance which is coupled to the closed oscillating circuit of the amplifier. We thus have a transmitting valve the grid potential of which is controlled from two sources, *i.e.*, the drive or the amplifier. The setting of these two reaction coils is of considerable importance, and should be so arranged that the grid is maintained in a state

of varying potential by the oscillator, whilst the other reaction coil which is coupled to the amplifier is used merely to stabilise this action.

In the positive high tension lead to this valve is inserted a large inductance which is known as a speech choke, and it is by means of this choke that the potential to the anode of the oscillating valve is varied. Each variation is carried through to the aerial and this superimposes on the carrier wave from the aerial a

We now come to the modulator panel which consists of two valves—the first of which is the control valve, whilst the second is the sub-control valve. Both these valves are lighted from the common low tension busbars which, as already mentioned, are connected to the low tension accumulator battery. The anode of the first valve is connected through the high resistance and through a protective choke to the speech choke, which is also

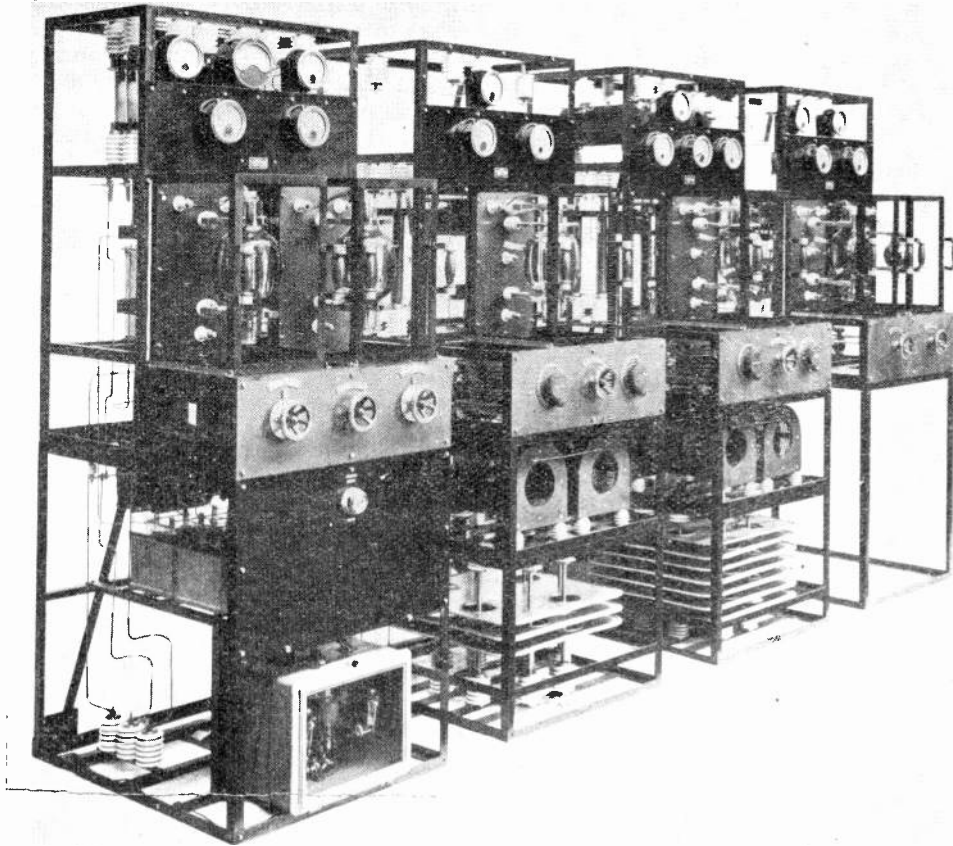

The Type of Transmitting Apparatus employed at the London Broadcasting Station.

complex ripple corresponding to the speech modulation. The aerial circuit is also connected in this panel and consists of an aerial terminal and variable inductance known as the aerial variometer and a coupling coil which is coupled inductively to the primary oscillating circuit. The end of this coil is connected through an aerial ammeter to the negative earth busbar.

connected to the positive high tension busbar. The grid of this valve is connected through a resistance to the negative busbar and also through a condenser to the anode of the second valve. This valve also takes its high tension current for the anode through a resistance and the protector choke from the positive high tension busbar, whilst its grid is connected through a transformer to the negative

busbar. The primary of this transformer is connected to the microphone in the Concert Room. When the microphone is spoken or sung into, the variation in its resistance produced by the voice causes a variation of the current flowing through the speech transformer, and causes a varying potential on the grid of the sub-control valve which in its turn causes a still larger variation on the grid of the main control valve, whilst this varies the anode potential of the amplifier valve, thus causing a speech ripple on the top of the carrier wave which is being radiated from the aerial.

The aerial of 2 LO consists of two cage or sausage type aerials, each of which have four wires, stretched between two masts which are nearly 50 feet above the roof, and approximately 100 feet apart. The lead roof of the building, the steel framework and the lightning conductors are bonded together to form a common earth for the system.

The Concert Room has received special attention, and although not ideal from the acoustic point of view, has been brought as near perfection as is possible by means of curtains suspended away from all the walls and hanging from the ceiling, whilst a thick

carpet covers the floor. The microphone is arranged near the centre of the room in such a manner that it picks up the sound from the various instruments which are grouped around it at distances which have been found to be correct, in order that no one instrument may predominate over the others.

Other special facilities which are already in use, or are contemplated, consist of a private line direct to Reuters, so that the latest news may be received whilst transmission is actually in progress, and it is hoped that a line may be connected direct with the Greenwich Observatory so that time signals may be radiated.

The photograph of the transmitter shows the four panels in the order mentioned. The left-hand one is the rectifier, which turns the alternating current into high tension direct current. The second panel is the drive oscillator, the third is the amplifier, whilst the fourth is the modulator panel.

The Station has a normal working range of seventy-five miles for reception on a two-valve set, but has been favourably reported on from as far away as Lerwick in the Shetland Islands—a distance of 550 miles, where Mr. Charles Coutts reports receiving its transmission on a single valve.

A Multilayer Inductance Coil.

THE CONSTRUCTION OF A ROBUST COIL HAVING VERY LOW SELF CAPACITY.

By C. E. WHEELER.

The serious experimenter occasionally requires a multilayer coil of exceptional y low self-capacity, and the writer proposes to give details of one form which was intended to be covered by a patent, but which however, was dropped whilst in the provisional stage.

Briefly, it consists of a coil wound in such a way that the individual turns and layers of wire are almost entirely

separated by an air space. Further, that when complete, it is hermetically sealed.

The method of construction adopted needs no particular skill—the principal requisite being a little patience. The exercise of the latter quality results in the production of a multilayer inductance coil having electrical properties probably as yet unequalled from a radio point of view



Low Capacity Coil sealed in cellulosid container.

The accompanying detailed illustration is almost self-explanatory, and for those who desire to make a few coils for themselves, the following particulars are given. Celluloid (the non-explosive variety) 40 and 20 mils thick should be obtained. The 40-mil material should be "loaded," and white celluloid will serve admirably. The 20-mil celluloid should preferably be transparent. These two items can be bought in sheets about the same size as foolscap paper. One or two ozs. of acetone, some 26 S.W.G. copper wire, silk or enamelled, and a 20-to-the-inch outside thread chaser are also required. All these materials are inexpensive, and the cost per coil need not therefore exceed a few pence.

The first operation should be to temporarily fix a sheet of 40-mil celluloid upon a flat surface, and with the aid of any convenient straight-edge as a guide, the chaser is drawn down the sheet parallel to one edge several times until grooves made by the chaser teeth are deep enough to accommodate the wire. The straightedge should be removed after a few distinct scores have been made. These will, in themselves, be sufficient guide for completion. The correct depth can easily be ascertained

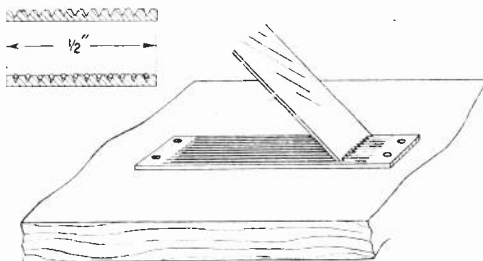

Making the grooves in celluloid with a chaser.

by placing a small piece of wire into a groove and putting a flat article upon the strip and noting whether the wire beds down satisfactorily. When the grooving process has been completed, the strip can be broken off the sheet and is then ready to be cut up into small pieces about $\frac{1}{8}$ in. long. This is easily accomplished in the following manner. The grooved strip is laid on a flat surface, and at intervals of $\frac{1}{8}$ in. a sharp carpenter's chisel, somewhat wider than the strip, is firmly pressed upon the grooved side of the celluloid. It is not desirable to force the chisel right through—the only thing necessary is to make cut marks upon it at intervals all the way along. Then with a small pair of flat-nosed pliers the strip can be broken up at the cut marks

into the small pieces previously referred to. The object of these small grooved pieces is for the purpose of separating the turns and layers of wire uniformly as will be seen in the illustration.

The next requisite is a short length of tube of ebonite or, preferably, celluloid. In the latter case two pieces will be required 40 mils thick, and the same width as the grooved strips. One of these should be a little longer than the other, and in order to form a short length of tube the following method is advised. A piece of metal tube, 5 or 6 ins. long and 2 ins. in diameter is procured, and the shorter of the two pieces of celluloid is made to encircle the metal tube and held in position by tightly binding with ordinary cotton tape. The whole is then plunged into a basin of hot water for about a minute, and then withdrawn. When cold the tape is unwound and the second piece of celluloid tied upon the first and plunged again into the hot water. These operations complete the forming of the tube rings. The next step is to place the smaller ring within the other with their joints 180 degrees apart. A turn of tape will be required to hold them closely together, and then a few drops of acetone is applied to the edges of the rings. This liquid will cause them to adhere and form one substantial ring or short length of tube. This ring can now be mounted in a chuck or other suitable winding device, and scratch marks made upon its periphery 36 degrees apart; the circumference of the tube will be divided into 10 equal parts.* Now 10 small grooved strips are neatly secured with a drop of acetone at each division and the winding of the first layer commenced. On completion of this layer, another set of 10 grooved strips is placed upon the first set and each secured as before. The wire at the end of the first layer is then carried across the coil, and the second layer proceeded with. In this connection it may be as well to mention that the operator should consistently wind all coils in one direction.

From this description a coil can be wound for any desired inductance. The final operations consist of enclosing the coil. Two circular discs of 20-mil celluloid, a little larger than the outside diameter of the coil are prepared, also a strip of the same material the width of the grooved strips and half an inch longer than the outer circumference.

* This operation can easily be effected with dividers if necessary.

Two small holes are made in the latter to allow for the ends of the winding to be externally available for connections. This strip is held securely around the coil by one or two turns of tape, and where the ends of the celluloid overlap a spot or two of acetone is applied. In a few minutes the tape can be removed. The coil is then laid on one of the circular discs and a few drops of acetone introduced at the inner and outer circumferences. After a few minutes have elapsed the celluloid covering the hollow part of the coil can be cut away with a small sharp knife. The coil is then turned over and the remaining disc fixed in a similar manner.

Owing to the great rapidity with which acetone evaporates when exposed to air, it will be found particularly advantageous to dissolve a little celluloid in some of this liquid and thus slow up evaporation. This solution however, should only be used for fixing grooved pieces one upon another. In all

cases the acetone and acetone solution should be applied with a small camel-hair brush.

Most 20-to-the-inch outside chasers will give nine grooves, and in cases where more than this number are required it is quite a simple matter to shift the chaser to one side in order to obtain any desired number of grooves.

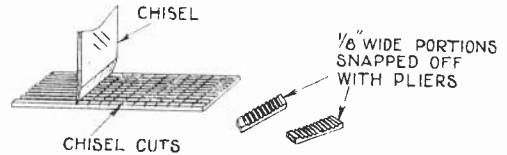

Cutting off the spacing pieces.

It should be noted that celluloid can be easily and accurately cut into strips. First mark off the widths, and using a metal straight-edge score a line with the point of a sharp pocket knife. It will then be possible, by bending, to break away the strip. In fact this operation very much resembles glass cutting.

Concerning the Experimental Licence.

AT the present time there is a good deal of uncertainty regarding the experimental licence and the conditions under which it is granted.

The purpose of the following article is to endeavour to explain the situation. Our own interpretation of the position will be given and in doing so perhaps some helpful suggestions may be put forward for the guidance of those who wish to avail themselves of the privileges which an experimental licence carries with it.

Prior to the introduction of broadcasting and the broadcast licence, the position was, of course, quite simple. Anyone who wished to conduct experiments in wireless applied for an experimental licence through the General Post Office, and obtained it with very little difficulty. At that time the authorities were not so seriously concerned with the question of radiation from oscillating receivers, since for the most part the radiation which took place interfered only with other amateur stations, and naturally this was no particular concern of the authorities who were only called upon to intervene when interference with commercial or Government stations was reported.

With the introduction of Broadcasting, however, a very different situation arose. The Post Office immediately became responsible

for seeing that the Broadcasting Service was not spoilt for those who paid for apparatus and licences to avail themselves of it. That the service would have been spoilt there is little doubt if the restriction that broadcast receivers should be *incapable* of oscillation had not been imposed. Judging from experience, especially in the London area, it is doubtful if even this restriction has entirely averted the danger.

In view of these circumstances it is not surprising that, when the issue of broadcast licences commenced, it became quite a difficult matter to obtain an experimental licence. Here we see the Post Office in a rather difficult position, for on the one hand it has pledged itself to take care of the interests both of the broadcast licensee and of the firms who jointly, as the British Broadcasting Company, were to undertake the broadcasting service; whilst on the other hand those who applied for experimental licences were clamouring for the same facilities to be granted to them as had been given to others who had applied for experimental licences at an earlier date.

From our own observations it appears that the course lately adopted by the authorities has been something in the nature of a compromise. At the time of writing, experimental licences are certainly being granted on a more

generous scale, but with the essential stipulation that the experimental set, when used on broadcasting wavelengths, must be so arranged as to be *incapable* of oscillation. This is a matter of fundamental importance, but we believe that if this one condition is faithfully fulfilled by the licence holder, then the Authorities will put no obstacle in the way of the man who wishes to experiment or construct his own set.

The majority of those who at the present time are applying for experimental licences, are not in quite the same position as those who made application for such licences prior to broadcasting. It would be absurd for anyone to suppose that broadcasting itself has not provided a very considerable additional attraction for those who take up wireless as a hobby. Probably for every ten applications for an experimental licence before broadcasting came into existence, there are now at least fifty. One cannot help feeling that a great number of these applicants, with perhaps a little knowledge of wireless, do not, at any rate at the moment, desire to conduct actual experimental work, but on the other hand they do wish to have facilities given them for constructing their own apparatus, and to have the satisfaction of knowing that the results they obtain are mainly the result of their own individual skill in making apparatus or assembling parts.

For the man who takes an interest in hobbies, far more enjoyment can be obtained from a set of home construction than from a receiver of fool-proof pattern purchased complete.

Having assured ourselves, therefore, that the Authorities are not likely to withhold an experimental licence from those who actually wish to make their own sets, it is perhaps as well to consider what is likely to be accepted as a definition of a "home-made" set.

First of all, it should be quite apparent that the assembling of units which simply require the terminals connecting together, does not constitute making a set; on the other hand we think it would be absurd to stipulate that in a home-made set every part should be of home construction. There are such units of apparatus as valves, telephones, filament resistances, intervalve transformers, valve holders, and so forth, many of which would be beyond the scope of even the most advanced amateur to construct, whilst other parts scarcely justify the time which it would take to make them when they can be purchased

for a reasonable sum from dealers in wireless apparatus. It should be safe to assume, therefore, that the inclusion of parts of this nature in "home-made" apparatus would not be an obstacle to obtaining an experimental licence.

In view of these remarks the particulars asked for under para. 4 of the Post Office Experimental License form seem to call for some modification. This paragraph reads:—

Particulars of the nature and objects of the experiments which it is desired to conduct with the apparatus.

In the case of many applicants for licenses this part of the form cannot be honestly filled up, yet an attempt to do so would probably always be made in the fear that otherwise the application would be rejected. In fact, the position with regard to the issue of experimental licences has been so altered as a result of the introduction of broadcasting that it seems to us there is every occasion for the Post Office Authorities to consider seriously the question of issuing an additional type of licence which would be a stepping-stone between a broadcast licence and the experimental licence which carries such full privileges as the holders of such licences now enjoy. By this it is meant to suggest that the additional licence might entitle the holder to construct for himself a specific set, the details of which, together with a circuit diagram, could be called for by the Post Office to accompany the form of application for the licence. After having held such a licence for a reasonable period of time, the next step might be to apply for a full experimental licence which could be granted by the Post Office with a feeling of greater security than is possible at the present time, when in some cases no guarantee at all can be obtained of the applicant's acquaintance with wireless.

In conclusion, the suggestion is made that when under the present regulations, application is made for an experimental licence, unless the applicant can give very definite particulars as to qualifications, he should accompany his application with full details of the set which he proposes to make, or give reference to say, a constructional article in *The Wireless World and Radio Review* which he desires to follow. Such information we feel sure would be a very valuable guide to the Post Office authorities in making their decision, and would probably be an important factor in speeding up the issue of the licence.

H. S. P.

Electrons, Electric Waves, and Wireless Telephony—XII.

By Dr. J. A. FLEMING, F.R.S.

The articles appearing under the above title are a reproduction with some additions of the Christmas Lectures on Electric Waves and Wireless Telephony given by Dr. J. A. Fleming, F.R.S., at the Royal Institution, London, in December and January, 1921-1922. The Wireless Press, Ltd., has been able to secure the serial rights of publication, and any subsequent re-publication. The articles are therefore copyright, and rights of publication and reproduction are strictly reserved.

3.—DETECTION OF ELECTRIC WAVES.

It will be clear, then, that to detect electric waves passing through space we have to place at that point an oscillatory circuit which is generally of the open circuit or rod type, which must have the capacity of its two parts with respect to each other and the inductance of its rod or wire so adjusted that the natural period of oscillation of the oscillator agrees with that of the wave to be detected. Next, that oscillator must be placed with its rods parallel to the direction of the electric force in the wave. If it is a nearly closed or loop receiving circuit, its plane must be coincident with that in which the electric force component of the wave lies.

The incident electric waves then produce in this receiving circuit a feeble oscillatory current of the same type as that in the transmitting circuit.

To complete the detection we have furthermore to associate the receiving circuit with some device called a *detector*, which is in effect a very sensitive kind of ammeter or voltmeter for detecting high frequency electric currents, and enables us to detect the presence in the receiving circuit of a very feeble electric oscillation.

There are only two types of such detector at present much used, viz., the crystal detector and the thermionic valve detector, but we shall mention first the coherer, as this form of detector enables us to show with great ease many of the properties of electric waves which are illustrative of wave phenomena in general.

It had been known for a long period of time that metallic filings formed a conductor of a peculiar kind, and that a glass tube loosely

filled with such metallic filings had a conductivity which varied in a very irregular manner.

Professor E. Branly, of Paris, drew attention in 1890 to the fact that an electric spark taking place near such a tube of loose metallic filings caused a sudden increase in its electric conductivity. The same thing appears to have been noticed previously in 1887 or 1888, by Professor D. E. Hughes, the inventor of the microphone.

Sir Oliver Lodge observed in 1893 the improved conductivity a loose or microphonic metallic contact produced when an electric oscillation passed through the contact and named the device a *coherer*.

Without entering into historical developments we may say that the coherer in the form given to it by Marconi, consists of a very minute quantity of metal filings, preferably nickel, with a small percentage of silver, which is contained between two silver plugs included in a glass tube.

The tube is exhausted of its air. The plugs are connected to two platinum wires sealed through the glass.

For certain laboratory and experimental purposes the author has used with advantage another form made as follows: A small ebonite box, like a little pill-box, has two nickel or silver wires passed through holes in the sides so that the wires are not quite in line (see Fig. 59). The wires where they pass through the box must be parallel to each other and about two millimetres or not more than $1/12$ th of an inch apart. They must otherwise rest on the flat bottom of the box. A very small quantity of fine clean nickel filings is then laid between them and this quantity has

to be adjusted until the greatest sensitiveness is obtained. The length of wire which projects beyond the box on each side is about three inches. A little stopper of ebonite is provided to close the top of the box. The two wires and the filings connecting them are joined in series with a single dry voltaic cell, and with the wire circuit of a device called a relay.

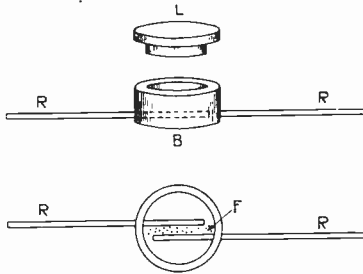

Fig. 59. A type of coherer used by the Author in Hertzian wave experiments.
 RR Metal wires.
 B Ebonite box.
 F Nickel filings between the wires in the box.

A relay consists of a pair of soft or pure iron bars round which are coiled many convolutions of fine silk-covered copper wire, through which the electric current from the battery cell can be sent. The iron then becomes a magnet and the arrangement is called an electromagnet. When the iron bars are thus magnetised, which can be done sufficiently with a very feeble electric current, the poles of the electromagnets are caused to

attract a pivotted piece of soft iron (see Fig. 60), called an armature, and pull it over against a metal stud which effects a contact and completes another electric circuit, which contains a more powerful battery of many cells and some instrument such as an incandescent lamp, an electric bell, or a printing telegraph instrument, which can give a visible, audible or legible signal. The relay is therefore a device by which the starting or stopping of a very feeble electric current can cause another very much stronger electric current to be also started or stopped.

Let us suppose then that we have two metal rods each a few inches long, placed in line with polished metal balls on their inner ends, with a small spark gap between them, so as to form a Hertzian oscillator.

It is desirable that this oscillator should be contained in a metal box with one end open (see Figs. 61 and 62).

By means of an induction coil or electrical machine, electric sparks are created between the balls. This results, as already explained, in the production of electric oscillations in the rods and in radiation of electric waves from them.

The wavelength of the waves radiated is approximately twice the overall length of the

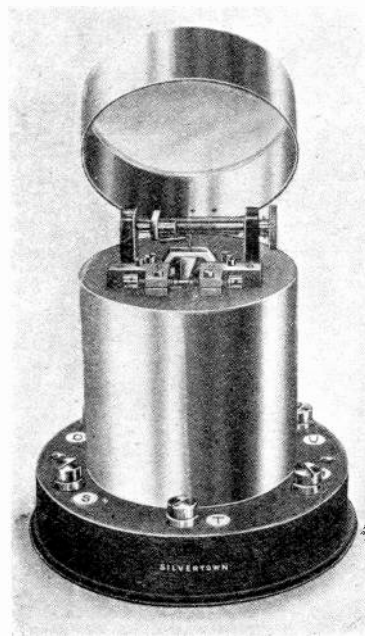
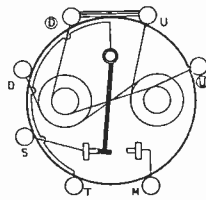
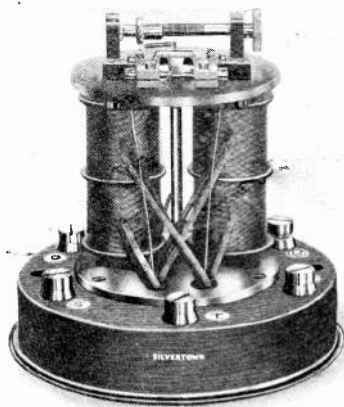

Fig. 60. A telegraph relay with outer case removed.

A telegraph relay.

two rods. Hence to obtain short Hertzian waves, that is, not more than a few centimetres in wavelength, the spark balls and the rods must not exceed in length half the desired wavelength.

It is necessary to connect these rods to the spark producing appliance, which is generally a small induction coil, through tightly wound up spirals of indiarubber-covered wire, called choking coils. The object of this is to hinder the electric oscillations generated in them from passing back into the induction coil. Another precaution is to have the spark balls highly polished, as this helps to produce that suddenness of the electric discharge which is a necessary condition for creating electric waves.

The receiving arrangements, comprising the metallic filings, coherer, and the extended wires, are placed in another metal box, open at one end, the two boxes being arranged with open ends facing each other and at a little distance, and the oscillator rods parallel to the collecting wires of the receiver (see Fig. 62).

It is very important that the wires which lead away from the coherer to the relay and voltaic cell and from the relay to the indicating device, whether lamp or bell, should be enclosed in a metal tube and all joints made tight. The object of this is to prevent the electric waves radiated from the transmitter affecting the coherer otherwise than by entering the open mouth of the receiver box.

To control the emission of waves from the transmitter it is necessary to insert in the primary circuit of the spark-producing coil a

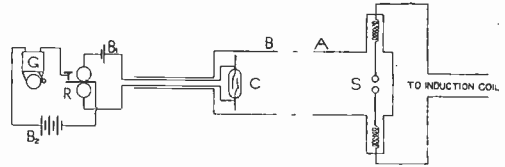

Fig. 61. Apparatus for experiments with short Hertzian electric waves.

- S* Oscillator rods in open mouth box *A*.
- C* Coherer in box *B*.
- R* Relay.
- G* Electric bell.

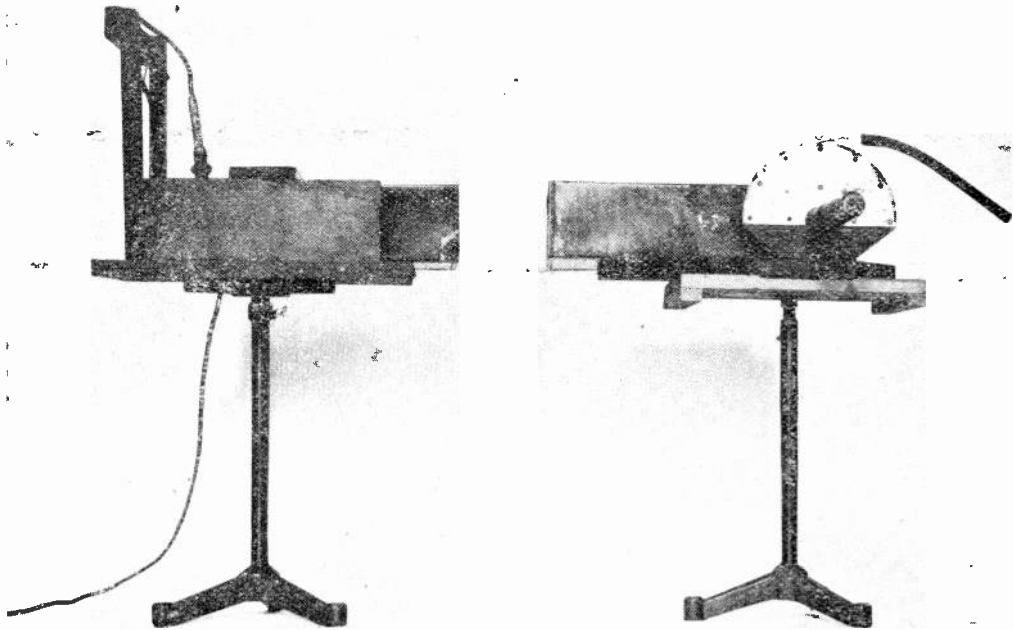

Fig. 62. General view of the Author's apparatus for showing experiments with short electric waves illustrating their similarity to light waves and the opacity or transparency of various substances.

switch or key so that we can create a spark of short duration between the spark balls by closing this switch for an instant.

A train of electric waves having a wavelength of a few inches then emerges from the open mouth of the transmitter box and enters that of the receiver or coherer box. These waves set up electric oscillations in the collecting wires, which causes the metal filings in the box to become highly conductive. The metal particles cling or cohere together. The voltaic cell in series then sends a current through them and through the relay, which in turn operates the detecting device and lights up the indicating lamp or rings the electric bell. This signal then shows that an electric wave has entered the receiving box. If we stop the transmitter spark and give the coherer box a smart tap or blow, this causes the metallic filings to cohere or fall back again into a badly conducting condition and the indicator lamp then goes out or the bell stops ringing.

Provided with this apparatus we can then demonstrate a number of the interesting properties of electric waves having a wavelength of a few inches.

In the first place if we hold between the transmitter and receiver boxes a sheet of metal, even a sheet of tin foil or silvered paper we find that the metal is opaque to these waves, and that the receiver is not affected.

The reason is because the electric waves falling on the metal sheet set up in it oscillatory electric currents, and these are exactly in opposite phase; that means moving in opposite directions to the currents in the oscillator rods which generate the waves. These currents in the metal sheet in turn create waves which, however, being in opposite phase, just nullify the effect of the incident waves on the receiver.

All good conductors are therefore opaque to this type of electric wave.

On the other hand bad conductors are transparent. If we hold a sheet of glass, ebonite or even a thick plank of dry wood between the oscillator and the detector, these electric waves are found to pass through it quite easily.

They pass also through many folds of dry cloth. If, however, the cloth is made wet, even a wet duster will do, it is found to be opaque to them. For this reason the human body, hand, or head, are also opaque, and stop these electric waves on account of the water in the tissues. A number of interesting

experiments may be made with flat glass bottles about 6 inches square and an inch in thickness. It will be found that the empty bottle is quite transparent to these waves. If filled with water it is quite opaque. If filled with paraffin oil, olive oil, turpentine or other insulating liquid it is found to be transparent.

Methylated spirit is transparent if quite free from water, but the water-adulterated mixture is semi opaque.

We learn from these experiments that, generally speaking, good conductors are opaque to long electric waves, and good insulators transparent.



Fig. 63. A grid formed by winding wires round a wooden frame.

This is not the case so strictly speaking for the very short electric waves which constitute visible light. In the latter case many aqueous solutions of salts called electrolytes, because they can be decomposed by an electric current, are transparent to light, and yet are good conductors. The reason is because in light waves we are dealing with electric displacement currents which are reversed hundreds of billions of times per second, and many substances which are good conductors for low frequency currents are not good conductors for such extra high frequency currents. Another interesting experiment can be shown with a grid of wire. If we wind copper wire round a wood frame so as to lay a number of parallel wires about half an inch apart across the frame in one direction (see Fig 63), we find that this grid is opaque to the electric radiation when the frame is held between the receiver and transmitter with the grid wires parallel to the oscillator rods, but is transparent when it is turned into a position such that the wires are perpendicular to the oscillator rods, the plane of the frame in both cases being perpendicular to the line joining the spark balls and the coherer.

The reason is because in the former case electric currents are set up by the electric waves in the grid wires, and in the latter case they are not.

The waves emitted are therefore said to be plane polarised; that means the vibrations are confined to one particular plane. This is the case with light waves when they have been transmitted through certain crystals such as tourmaline.

We can next exhibit the reflection and refraction of these invisible electric waves, and show that they behave like waves of light.

If we turn the transmitter and receiver boxes with their open ends in nearly the same direction, but placed not quite near each other, it is possible to find positions in which the emitted waves do not enter the receiver box and affect the coherer. If, however, we hold a sheet of metal we can reflect the invisible electric beam into the mouth of the receiver box and so affect the coherer.

Moreover, we can do the same thing with a wet duster, and also with the grid of wires provided we hold the grid in such a position that its wires lie in the same plane as the rods of the oscillator.

We shall see later on in speaking of wireless telephony that we can in this manner construct reflectors for electric waves which are not very cumbersome or costly, and especially do not offer much surface to wind.

We can also refract or bend the direction of these waves by means of prisms made of paraffin wax (see Fig. 64).

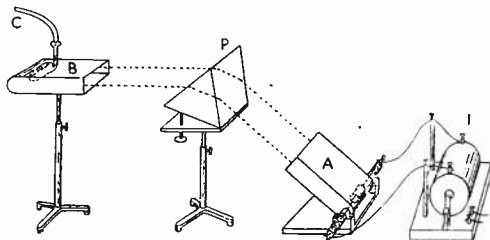

Fig. 64. An experiment with the apparatus shown in Fig. 62 to illustrate the refraction of short electric waves by a paraffin prism.

Again it is possible to produce, as Hertz did, interference effects and to cause two sets of waves to augment or to destroy each other just as in the case with waves on water or waves in air.

In short, we can exhibit with this invisible electric radiation similar phenomena to those with which we are so familiar in the case of

light, viz., opacity, transparency, reflection, refraction, polarisation, and interference. Great experimentalists, following Hertz's initiative, have therefore built up a body of irrefutable proof that in this invisible electric radiation of long wavelength we are dealing with an agency identical in nature with light, except that it cannot affect our eyes but can only influence certain artificial eyes called aerials and detectors.

This is perhaps the best place to mention the range of these known and also of the unknown wavelengths which are comprised by this electric radiation. It will be convenient to adopt a term from the science of music and call an *octave* of radiation all those waves which are included between a certain particular wavelength and a wavelength of exactly double or else half that length.

We may, then, compare the electric waves of different frequency, extending over a great range, with the keyboard of some large organ in which each key corresponds to a different wavelength. In the case of an organ a compass of eight or nine octaves includes all the range of musical sounds, but in the case of electric waves we are acquainted with wavelengths extending over nearly 50 octaves, ranging from the longest athermal billows of 20,000 metres in wavelength down to the tiny ripples of less than 1 Angström unit in wavelength which constitute a certain class of X-ray.

Beginning, then, with the longest electric waves, we can say that the range of wavelength of waves used in wireless telegraphy and telephony extend from 20,000 metres to 10 metres, or, say, over 11 octaves of wireless waves. Then beneath these we have the Hertzian waves which range from about 10 metres to 5 centimetres in wavelength, or, again, about 11 octaves.

Beneath these we have a range of electric waves from about 5 centimetres in wavelength to 0.3 millimetres, or about 8 octaves of radiation, which has not yet been created and are therefore unknown.

Again below these, we find the dark heat-waves stretching from 300 microns (μ) or $\frac{1}{3}$ of a millimetre in wavelength to about 0.8 μ or 8,000 Angström units (A.U.). These 7 or 8 octaves of radiation can make themselves evident by their heating action on sensitive thermometers, but do not affect our eyes as light. Extending in wavelength merely 1 octave

from 0.8μ to 0.4μ in wavelength, we have that small range of electric waves which can affect the human eye as light. Beyond the violet rays there is a range of 3 or 4 octaves or more of invisible light, which cannot affect our eyes but can impress a photographic plate, and produce other effects. These are called the ultra violet waves, and their wavelengths extend from about 4,000 A.U. down to perhaps 500 A.U. or less.

Below these there is another gap of unknown or unproduced wavelengths, and then

we come to the region of X-rays and Y-rays, which are electric waves with wavelength of the order of 1 A.U. or less.

We are therefore acquainted with the properties of a vast gamut of electric waves with, however, two gaps in it of unknown waves, but covering on the whole about 50 octaves of radiation. For all we know there may be in the economy of nature waves of still greater or still less wavelength as yet unproduced.

(To be continued.)

Distributing Problems of Radio Manufacturers.

By M. B. SLEEPER.

In the following article Mr. Sleeper describes some of the difficulties which were experienced in America in the process of establishing the wireless industry on a sound footing.

ALTHOUGH the experiences of radio manufacturers in England may differ from the series of events which have taken place during the first year of broadcasting here, the general outline will probably be the same. Possibly some of the very expensive errors made by the majority of our manufacturers and dealers that have almost paralysed the industry may be worth relating.

Last Christmas the demands of the public upon the dealers were such that they were operating on the daily deliveries from the manufacturers. The latter, sensing a great increase in business, bent all their efforts to enlarge their facilities. New companies sprang into existence, in the main duplicating the products of existing concerns. The newcomers found plenty of orders, because the dealers knew that, of whatever they ordered, only a small part would be delivered. We call it "pyramiding" orders.

For example, a dealer who could sell a thousand rheostats a month ordered two thousand from each of six companies, with the idea that the total of the partial deliveries might make up that amount. Because of this phantom of demand, manufacturers lost their perspective and tried to get on an immediate delivery basis. In the meantime business developed so rapidly that, when they could deliver a thousand rheostats the dealer could sell ten thousand. Moreover, new stores opened up by the hundred, and a certain amount of goods had to be turned out to supply each one.

Jobbers also 'jumped into radio, bringing with them the question of jobbers' discounts.

Many of them, instead of selling to the stores, took advantage of the jobbers' discounts, but sold directly to consumers. Department stores, one after another, opened radio departments, complicating matters by asking for jobbers' discounts. Moreover, machine shops and "cellar factories" made trouble by offering jobbers' discounts to the retail stores. Radio stores included, by the way, ironmongers, chemists, tailors' shops, millinery stores, shoe stores, sporting goods and clothing shops, stationery stores, garden implement houses, motor car accessory shops, garages—in fact, almost any kind of place selling to the public.

Before this time we had had no real jobbers, and no one could definitely define a radio jobber anyway. As a result many manufacturers sold in large quantities to stores whose purchases on credit were really not justified by their normal credit rating. Then however, their turnover was so rapid that they could easily pay their bills and—here is where the trouble came—they were allowed to continually increase the size of their orders.

In May the crash came. The production of established manufacturers, plus that of the newcomers, reached the demand, and the consumers' purchases fell off slightly. Immediately orders were cancelled right and left. A little later goods were returned to the manufacturers. Retailers stopped paying their bills.

The effect was first felt by new manufacturers who had ordered materials in huge quantities, for theirs were the first orders to be cancelled. As a result, they had no accounts

receivable to cover their accounts payable. They had not had time to establish themselves in the minds of the public, nor had they advertised extensively. One after another closed shop in rapid succession.

During July and August the strain was felt by the older concerns, for both orders and collections fell off to almost nothing. Since they sold directly to retailers instead of putting orders through jobbers of high financial standing, they found trade connections, built up at great expense, of no further value. Many retailers, finding business poor during the summer, quickly disposed of their stocks, but showed no interest in paying their bills, because, having made money during the period of great demand, they decided to go back to their old business, that of selling medicine, clothes, shoes, or whatever it was.

This autumn, orders have been very slow at first where, ordinarily, things are in full swing by the middle of September. This was due to the fact that many stores were still stocked with last spring's purchases and the public was waiting for the end of the unreasonably warm weather we were experiencing. Some retailers could not and others would not pay bills dating back to April and May until trade resumed. In the meantime many manufacturers who kept up production right through the summer, in preparation for autumn demands, had not been able to finance themselves, and had gone under. This has put on the market a tremendous amount of merchandise at sacrifice prices. In many cases goods are offered at one-fourth their advertised prices.

All this has benefited, in a way, those who are able to stay in business, though the lessons learned have been dreadfully costly. Credit relations between material supply houses and manufacturers, as well as with the banks, have been strained, often creating a lack of confidences in the manufacturer at a time when he needs the greatest assistance.

A word about discounts may be of interest. Discounts to retailers have been established at 25 and 30 per cent., sometimes running to 33 $\frac{1}{3}$ per cent. Jobbers are allowed 40 per cent., and distributors who cover the territory of several jobbers are given 50 per cent. Distributors have been necessary here because the United States is too large to be covered from one central office. In England, on the other hand, the population is sufficiently concentrated that this necessary evil may not be needed.

Comparatively little of the autumn business is being handled directly with the retailers. Such orders are now filled by shipping the order to the jobber who covers the city where that retailer is located. The goods are billed to the jobber who, of course, has demonstrated his financial standing prior to his appointment. Such distribution has been achieved that the fraction of direct mail orders from the consumer is very small. Manufacturers generally try to sidestep mail orders by advertising that their goods can be purchased in the local stores.

It has not been my intention in the foregoing paragraphs to paint a black picture of the radio situation here as a prophecy of conditions in England. On the contrary, my desire in preparing these notes was to present a rough outline of our experience with the hope that from them some helpful ideas might be obtained by the English manufacturers in whose work I have always been interested, and for whose products, particularly after my visit during the summer, I have the highest regard.

Compact Short-Wave Receiver.

Embodying the tuning principle described in a constructional article in this Journal,* Mr. E. G. Nurse has built this compact crystal receiving set, which he states gives very

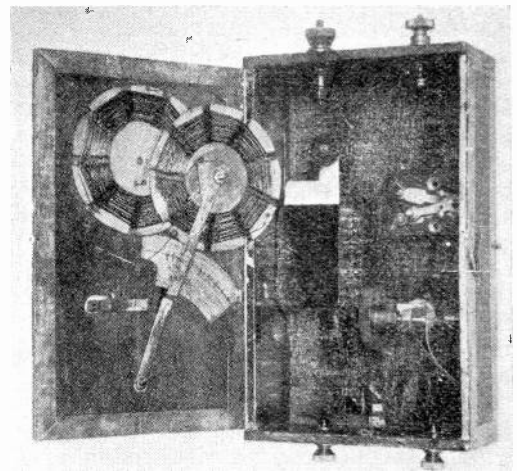

satisfactory results. Tuning is effected by moving the relative positions of two flat coils connected in series. As will be seen, a cigar-box is used as a container for the parts.

* Page 329, June 10th, 1922.

Experimental Station Design.

XVIII.—A 10-WATT C.W. AND TELEPHONY TRANSMITTER.

THIS low power transmitter is designed to embody a minimum of parts and to be operated efficiently with the smallest number of adjustments. Consequently, as will be seen, the anode of the oscillator valve is connected directly to the aerial inductance instead of making use of loose coupled circuits. Such an arrangement is usually quite satisfactory for telephony transmission where considerable damping is introduced, though may cause complications when the H.T. is derived from a source having a potential above earth. It might be mentioned here that where public supply mains are in any way connected in the high tension circuit it is advisable to connect condensers having fixed values greater than 0.005 mfd. in both aerial and earth leads, for although one main may be earthed at the power station it will develop a difference of potential to earth at the experimenter's premises owing to its resistance and the heavy currents that may be flowing.

The components embodied in this set may be wired up to the particular principle most favoured by the experimenter, but the parts shown include those necessary for the various arrangements for different methods of transmission.

The panel, owing to its size and the number of instruments it has to support, should have a thickness of at least $\frac{3}{8}$ in. Its other dimensions will depend upon the particular makes of the components selected, and the one shown measures 13 ins. by $8\frac{1}{2}$ ins. The former for the aerial circuit inductance consists of a piece of ebonite tube having an external diameter of $3\frac{1}{4}$ ins., and a wall thickness of about $\frac{1}{8}$ in to $\frac{3}{16}$ in. It is attached to the panel by two brackets made from $\frac{3}{8}$ in. ebonite sheet and shaped to fit to the face of the tube.

Two 4 BA screws at each end of the tube will secure it to the brackets while 3 BA screws are used to attach the brackets to the panel. A smaller ebonite former is required to rotate inside the aerial circuit former to carry the grid circuit inductance. This should have an external diameter and length of each 2 ins. It is mounted on a spindle which has one bearing in the ebonite panel and the other in the aerial circuit former on the side most distant from the panel. The side of the former

which is nearer to the panel has, of course, a clearance hole. More precise details for fitting up this former were given on page 866, in September 30th, 1922, issue. The spindle is fitted with knob and dial to indicate the setting of the grid circuit coupling.

The winding of the aerial circuit inductance depends upon the dimensions and resistance of the aerial circuit. A small aerial will necessitate the inclusion of many turns to produce a wavelength of 440 metres, whilst a high resistance aerial will also require a large number of turns in order that the anode tap may include sufficient inductance to excite the aerial circuit. Most experimenters are now, however, devoting their attention to wavelengths between 150 and 200 metres owing to the inauguration of broadcasting. For these short wavelengths a special aerial must be erected, and a vertical single wire 50 or 60 ft. in length serves very well; or better still, a vertical iron pipe standing on an insulating base and guyed with well insulated and split up stay wires is very useful for short wave experiments in both transmitting and receiving, as no capacity fluctuations occur as in the case of a wire aerial, due to swinging. For short wavelengths, and with a special aerial, the aerial inductance may be wound with insulated strip wire such as is used for winding transformers, and having a width of about $\frac{1}{8}$ in. and a suitable thickness, say No. 26 S.W.G. The turns should be spaced by either leaving a small gap of about $\frac{1}{16}$ in. between the turns as they are put on, or winding on with the wire and between the turns a piece of thin twine. For the longer wavelength of 440 metres with an aerial approximately the dimensions specified by the Post Office, the inductance may be wound with No. 18 D.C.C.

Every turn should be tapped out to a socket on the front of the panel. If none of the usual types of socket are available, single valve stems may be used for the purpose. Plugs must be provided to fit these sockets for tuning the aerial and connecting the anode tap.

The grid circuit former should be wound with No. 22 D.S.C., and the exact number of turns required must be found by experiment after the grid circuit condenser has been built up. The tuning condenser should be put

in a mid position and connected across the inductance with a crystal detector and telephones, and then by means of a buzzer wavemeter set to the normal wavelength on which it is desired to transmit, the number of turns may be adjusted.

Spacing washers of more than the usual thickness should be used for building up the grid circuit tuning condenser in order to provide for greater spacing between the plates.

A suitable value for the grid leak will depend upon the type of valve used, and two or three leaks should be constructed so that one having the most suitable value can be employed. An approximate value is 10,000 ohms, and it should be made up by winding No. 40 D.S.C. "Eureka" or other resistance wire, non-inductively on a short piece of 1-in. ebonite rod, as shown immediately below the transformers in the diagram illustrating the back

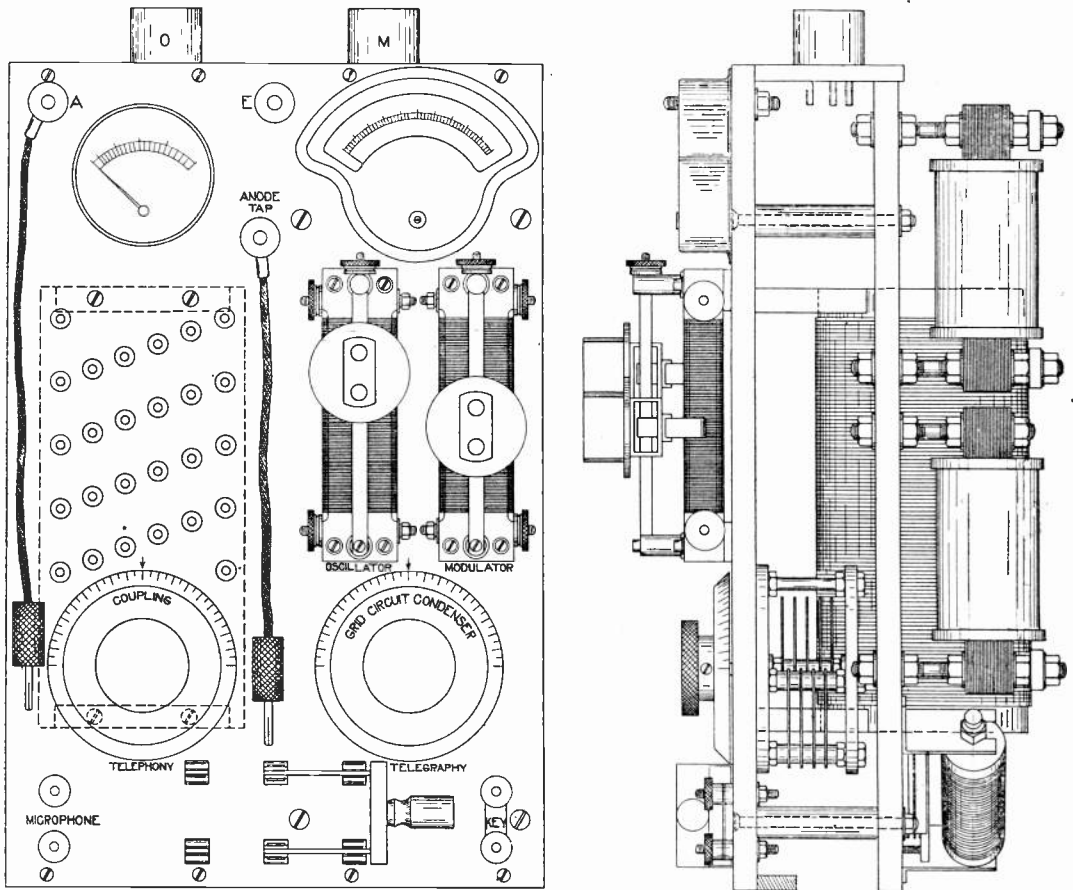

Front and Side views of C.W. and Telephony Transmitter. Scale $\frac{1}{2}$ full size.

The capacity of this condenser need not exceed 0.0002 mfd. if the transmitter is to be used only on one wavelength.

The grid condenser which has a value of 0.002 mfd. must be built to withstand higher potentials than the type of condenser used in receiving circuits. If mica $\frac{2}{1,000}$ in. thick is used for building up this condenser, then it is best made in three sections mounted together and connected in series.

view. The ebonite rod should be revolved, and the wire run on from two reels, the starting ends being joined together. The weight of wire required to produce a given resistance can be calculated and adjusted on the reels before winding is commenced. Another method of winding the leak, and one not so liable to breakdown, is to wind on from one reel only making reversals at intervals. For instance, wind on a single layer for a quarter

of an inch, and then cover this with another layer in the same direction. Loop the wire and for the same number of revolutions, as may readily be determined when using a treadle lathe, by counting the number of times the treadle is operated, wind on two more layers over the first two. Make a number of sections side by side along the former similar to the one just produced, and by this method the potential is distributed.

suitable, and occupy small space considering the high potentials which they are designed to withstand. This condenser can probably be mounted immediately behind the variable resistances.

The high frequency choke coil also is not shown. It may be mounted immediately behind the aerial circuit ammeter. It should consist of a single layer of No. 28 D.C.C. on a 2-in. ebonite former $2\frac{1}{2}$ ins. in length.

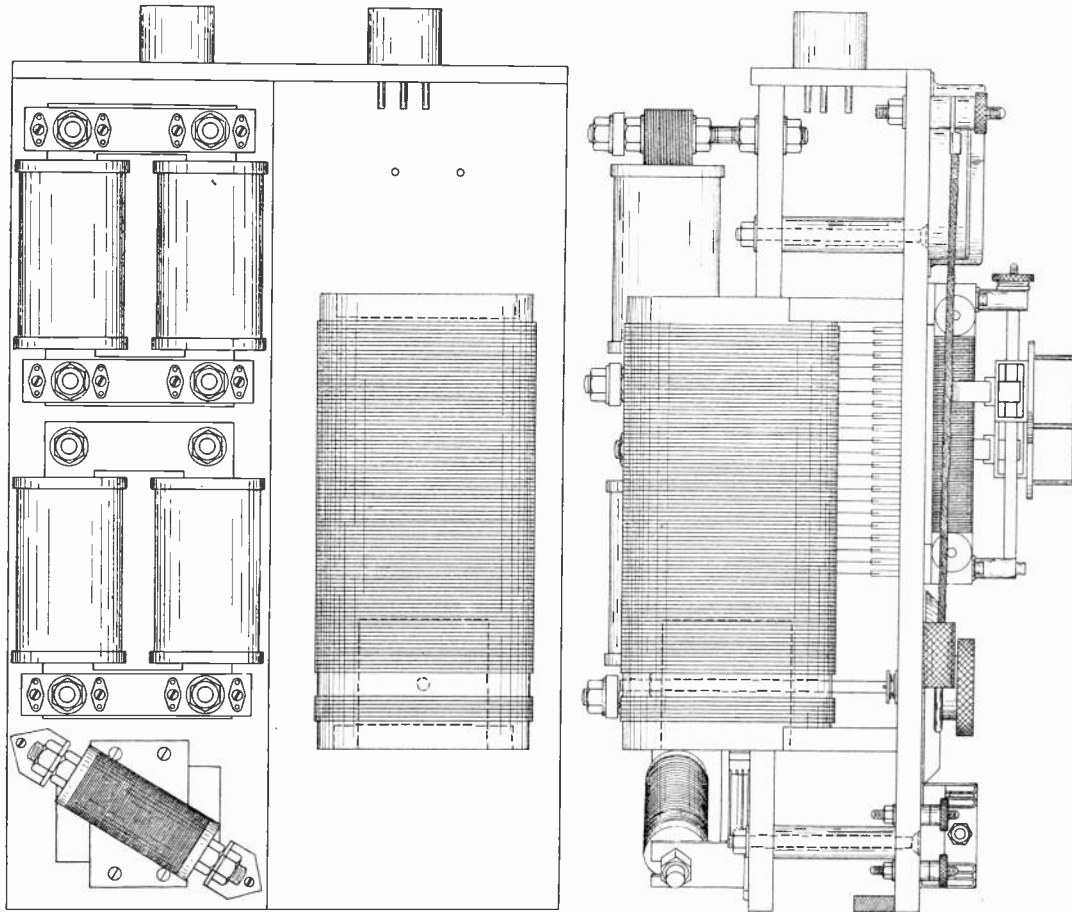

Rear and side views. The wiring and parts liable to confuse the drawing have been omitted.

The condenser in the anode lead has not been introduced into the diagrams as the type selected will depend upon the materials the experimenter may have to hand. It should be designed to withstand a potential of at least 5,000 volts, and may be built up of a number of mica dielectric condensers clamped together and connected in series and buried in good quality insulating wax. Dubilier condensers are, of course, particularly

The iron core choke coil is the lower one in the back view of the panel. Its core is built up from $\frac{3}{4}$ -in. iron strip, and the corners are interleaved, thus, if the sides are 3 ins. by $4\frac{1}{2}$ ins. then the strips will need to be cut to $2\frac{1}{4}$ ins. and $3\frac{3}{4}$ ins. If the strips are held together by bolts through the corners, then clearance holes must be made for the bolts in order that they may be wrapped with mica or thin fibre so as to avoid putting the plates in

electrical contact. Mica or fibre washers should be placed under the nuts, and one side of all the strips should be given a thin coat of varnish or enamel. Unless good tools are available it may be difficult to neatly drill the corners, in which case the ends may be clamped together between $\frac{1}{8}$ -in. thick, brass plates. Strips of ebonite are arranged to carry the connecting tags for soldered connections. The bobbins, having a length of $2\frac{1}{2}$ ins. and a diameter of $1\frac{1}{2}$ ins., are wound full with No. 30 S.S.C., a piece of thin paper being placed between each layer.

The microphone transformer is of similar dimensions to the choke coil, but each bobbin has a primary winding of four layers of No. 26 D.S.C., and a secondary of No. 38 S.S.C.,

A milliammeter is connected in the H.T. + lead, and should read up to 50 or 100 milliamps and should be of the moving coil variety.

A hot wire ammeter having a full scale reading of 0.5 amperes is required in the aerial circuit.

Valve holders are, of course, needed for oscillator and modulator. The valves may be either A.T. 15, 30 or 40X, according to the power used. The use of valves rated to dissipate more energy than that normally used are recommended.

A switch is shown on the front of the panel for working either telegraphy or telephony. This switch is not essential, as when working telegraphy it is only necessary to remove the

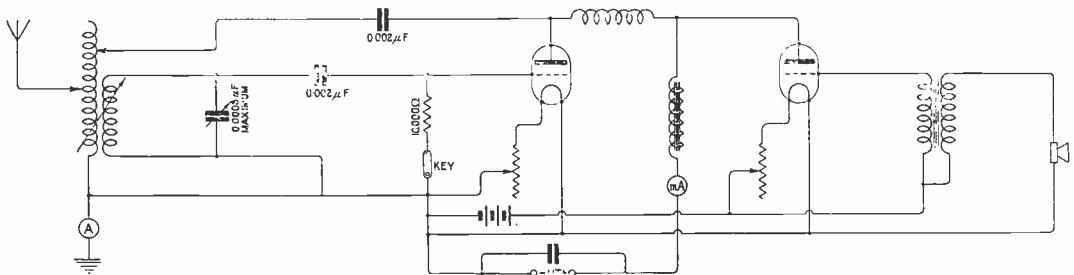

Transmitter Circuit making use of the "Choke Control" method of modulation.

with insulation between layers. Each winding is brought out on to separate tags so that if desired the primary or secondary windings may be paralleled.

The usual type of sparking coil may be employed to replace this transformer when its contacts are screwed up. The secondary winding of a similar coil may be used as a choke.

The selection of the microphone is left to the experimenter, but the "solid back" types as used by the Post Office, and which can be obtained from the telephone manufacturing companies, are specially recommended.

The filament resistances should be capable of passing 4 amperes without heating, and the type illustrated is particularly convenient.

modulator valve and break the microphone circuit. It is intended that one lever of the switch transfers the grid connection of the second valve to the grid of the oscillator valve, whilst the other transfers the modulator valve plate to the oscillator plate lead, thus throwing the valves in parallel.

The terminals for the filament battery and the high tension supply may be arranged at the back of the instrument. The H.T. may be derived either from a D.C. high voltage generator or by stepping up from a high periodicity A.C. supply and using rectifying valves. An instrument making use of the latter method will be described in the next article under this heading.

F. H. H.

ELEMENTARY INSTRUCTIONAL LECTURE.

An experimental Lecture dealing with the Principles of Radiotelephony, and primarily intended for Associates of the Radio Society of Great Britain, will be given by G. G. Blake, M.I.E.E., A.Inst.P., at the Institution of Electrical Engineers on January 12th, at 6.30 p.m. Tickets will be sent to Associates. All interested are invited, and tickets can be obtained by sending a stamped and addressed envelope to Mr. Leslie McMichael, Hon. Secretary, The Radio Society of Great Britain, 32, Quex Road, West Hampstead, N.W.6.

Wireless Club Reports

NOTE.—Under this heading the Editor will be pleased to give publication to reports of the meetings of Wireless Clubs and Societies. Such reports should be submitted without covering letter and worded as concisely as possible, the Editor reserving the right to edit and curtail the reports if necessary. The Editor will be pleased to consider for publication papers read before Societies. An Asterisk denotes affiliation with the Radio Society of Great Britain.

Correspondence with Clubs should be addressed to the Secretaries direct in every case unless otherwise stated.

Wolverhampton and District Wireless Society.*

Hon. Secretary, Mr. J. A. H. Devey, 232, Great Brickkiln Street, Wolverhampton.

On November 28th the above Society held several experiments with regard to the reception of broadcast music, etc., to which many of the leading local scientific gentlemen were invited.

The experiments, which proved highly successful, were made on crystal and valve sets, including an Armstrong super-regenerative set, telephony and music being distinctly heard with the use of the frame aerial, a loud speaker being employed.

The usual Wednesday meeting held on the 29th took the form of five to ten-minute papers given by members on any subject pertaining to "Wireless," some very practical hints being given by Mr. E. Blakemore and Mr. W. Harvey-Marston.

North London Wireless Association.*

Hon. Secretary, Mr. V. J. Hinkley, Northern Polytechnic Institute, Holloway Road, N.7.

At a meeting of the Association, held on November 27th, Mr. F. S. Angel gave his third paper on "The Elementary Principles of Radio Telephony."

Mr. Angel gave an explanation of the general principles of wave-motion, using various analogies to illustrate his points. Two mechanical lantern slides, one for showing transverse and the other longitudinal vibrations, were on loan from the Physics Department.

A discussion took place, from which it was apparent that the lecture had been followed with a great amount of interest.

Hackney and District Radio Society.*

Hon. Secretary, Mr. E. R. Walker, 48, Dagmar Road, London, E.9. (Stamped addressed envelope should accompany enquiries.)

On November 30th it was stated that the lecturer for the evening, Mr. J. W. Francis, who had promised to lecture on "Electrical Units," was unfortunately ill, and the meeting was therefore given over to informal discussion. Various sets of apparatus were exhibited and demonstrated, 2 LO and Birmingham coming in quite clearly. A small neatly-made crystal set was also exhibited, made by a young member of the Y.M.C.A. section of the Society. The Vice-Chairman promised to award a prize to the Y.M.C.A. member making the best crystal set by Christmas.

The Chairman announced that the Mayor of Hackney had agreed to become the first President of the Society, and Sir Arthur Lever, the new M.P. for Central Hackney, the first Patron.

Full details of the subscriptions to the Society appeared in *The Wireless World and Radio Review*, on December 2nd.

Sutton and District Wireless Society.*

Hon. Secretary, Mr. E. A. Pywell, Stanley Lodge, Rosebery Road, Cheam, Surrey.

At the meeting held on November 29th, 1922, one of the members, Mr. J. F. L. Corkett, B.Sc.,

gave a very interesting lecture on "The Wireless Service During the War." This was illustrated with lantern slides, kindly lent for the occasion by Marconi's Wireless Telegraph Co., Ltd. At the close, he was accorded a hearty vote of thanks.

Meetings will in future be held on the second and fourth Wednesdays in the month at the same time and place as previously, namely, 8-10 p.m. at the Adult School, Benhill Avenue.

There are now 36 members.

Leeds and District Amateur Wireless Society.*

Hon. Secretary, Mr. D. E. Pettigrew, 37, Mexborough Avenue, Chapeltown Road, Leeds.

An Exhibition of Apparatus and Demonstration of Wireless Telephony was held on December 1st and 2nd. A large display of members' apparatus was on view.

A general meeting was held on December 8th at the Grammar School, Mr. G. P. Kendall, B.Sc. (Vice-President) being in the chair. A lecture on and demonstration of "Recording Apparatus" was given by the President.

Belvedere and District Radio and Scientific Society.*

Hon. Secretary, Mr. S. G. Meadows, 1, Kentish Road, Belvedere, Kent.

On December 4th Mr. A. H. Norman lectured on "Common Faults in Receiving Circuits." He gave reasons for many of the extraneous noises heard in the 'phones, which tends to make wireless reception uncomfortable, and explained how they may be eliminated.

The Secretary mentioned that the time allotted for questions was not sufficient, so a special evening had been arranged for a discussion on "The Difficulties Experienced by the Wireless Amateur."

Cardiff and South Wales Wireless Society.*

Hon. Secretary, Mr. P. O'Sullivan, 37, Colum Road, Cardiff.

A general meeting of the Society was held at Headquarters, The Engineers' Institute, Park Place, Cardiff, on November 23rd, Mr. E. Ogden presiding.

A letter was read from Commander J. R. Schofield, accepting the office of Presidency of the Society for the year 1922-23.

Mr. Alex Lawrence, who recently left this country in order to take up a position in Persia, wrote resigning from the Committee of the Society. The Secretary commented upon the excellent work Mr. Lawrence had performed whilst he had been with the Society. It was decided that the Secretary write Mr. Lawrence thanking him for all the kindnesses he had rendered in the past, and wishing him every success on his new adventure.

Mr. Norman M. Drysdale lectured on "Radio Telephony." Mr. Drysdale concluded his lecture by having cast on the screen a picture of the transmitting apparatus used at Marconi House.

Many questions arose out of the lecture, a lengthy discussion taking place on the "Heavyside Layer."

Thames Valley Radio and Physical Association.*

Hon. Secretary, Mr. Eric A. Rogers, 17, Leinster Avenue, East Sheen, S.W.14.

It was announced on December 1st that Mr. Becker, M.P., had accepted Vice-Presidency, and that the Association had become affiliated to the Radio Society of Great Britain.

Major-General Shaw was thanked for his gift of a blackboard.

Meetings are to be held weekly in future, alternate weeks to be informal and formal. Minutes are not to be read at the informal meetings.

Mr. Blake gave an elementary lecture on "Broadcasting, the Ether and other Experiments."

A vote of thanks was proposed to Mr. C. Wilson for his generous gift of 12 valves. Forty members and 15 visitors were present, and two new members joined.

Southport Wireless Society.*

Hon. Secretary, Mr. E. R. W. Field.

The third annual meeting was held on December 5th. The Secretary, Mr. R. Brown, reported that the last year had been most successful. The membership had more than doubled, and there was a substantial cash balance in hand. The election of officers resulted as follows:—President, Mr. Taylor; Chairman, Mr. R. Brown; Secretary and Treasurer, Mr. E. R. W. Field; Committee, Messrs. A. Stock, R. Wilde, Capt. F. C. Poulton, O.B.E.

Mr. Field referred to the death of the Vice-President, Colonel A. D. Lomas. It was unanimously agreed not to fill the vacancy for a year, as a mark of esteem for Colonel Lomas. A "hot-pot" supper followed. The programme for the ensuing year was announced, and a vote of thanks to the retiring Secretary, Mr. R. Brown, closed the meeting.

Bradford Wireless Society.*

Hon. Secretary, Mr. J. Bever, 85, Emm Lane, Heaton, Bradford.

Mr. A. Leardet lectured on "High Frequency Amplification" on December 1st.

The Society has purchased a "Lokap" coil winding machine, which will be installed in the instrument room.

Redhill and District Y.M.C.A. Wireless Society.*

Hon. Secretary, Mr. J. S. B. Clarke.

A Committee meeting was held on November 29th, when it was decided that a "Gadget" competition, and a sale of "Junk" should be held on December 20th.

Gadgets to be submitted to Mr. Johnson, Y.M.C.A., Station Road, Redhill, before that date.

The Club held an open night on December 13th, when Mr. Pope lectured and demonstrated.

Manchester Radio Scientific Society.*

Hon. Secretary, Mr. H. D. Whitehouse, 16, Todd Street, Manchester.

Mr. G. G. Boullen occupied the chair on November 22nd. Mr. Holmes lectured on "The Armstrong Super-Regenerative Circuit." Afterwards a frame aerial demonstration was given, 2 ZY Manchester being heard quite distinctly. A hearty vote of thanks to Mr. Holmes was passed.

On November 29th Mr. G. G. Boullen took the chair. New members were elected. Mr. J. R. Halliwell opened a discussion on "Broadcasting."

Ramsgate, Broadstairs and District Wireless Society.*

Joint Hon. Secretaries, Mr. F. Harrison, "Rochester Cottage," St. Lawrence (Ramsgate), Mr. F. C. Marshall, 6, Ramsgate Road, Broadstairs (Broadstairs and District).

On October 21st, Mr. F. Harrison gave a very entertaining and practical lecture on "Valves," kindly bringing various types to illustrate. He was accorded a hearty vote of thanks. The next weekly lecture was given by Mr. P. F. Weeks, M.B.E., who chose for the benefit of the younger members, "A Simple Crystal Set and its Construction," and brought one of his own sets for the members to examine.

A "Question Night" was held the following week. The Society is erecting a two-valve set.

The death of two Vice-Presidents, Mr. W. G. Riddle, and Mr. Charles F. Grossmith, is regretted.

The Society have now permanent headquarters at the Y.M.C.A., Ramsgate, where they will meet every Tuesday.

Mr. W. Ford Wells, of "Wykeham," Broadstairs, has been elected as a Vice-President.

The membership is increasing slowly but surely.

Wireless Society of Hull and District.*

Secretary's address, 79, Balfour Street, Hull.

A departure from the usual programme was made at the bi-monthly meeting on November 24th, when the evening was devoted to a sale of members' surplus apparatus. Mr. Henry Strong was in the chair. Five new members were elected and a vote of thanks passed to the D.P. Battery Co., of Bakewell, for the gift of a volume for the Society's library. There was a good show of apparatus; the attendance was large.

Buzzer practice will take place at 7 p.m. at each meeting. The Society meets on the second Monday and fourth Friday in each month.

Stoke-on-Trent Wireless and Experimental Society.*

Hon. Secretary, Mr. F. T. Jones, 360, Cobridge Road, Hanley.

Mr. F. T. Jones read a short paper on "The Abuse of Reaction," on November 30th, at the Y.M.C.A., Hanley. Mr. Jones clearly illustrated some methods of overcoming reaction difficulty, and a lively discussion followed.

It has been decided to construct a multivalve receiver for the use of the club, and a committee, consisting of Messrs. Bew, Clarke, Steel and Whalley was elected for that purpose. The set will be constructed on Thursday evenings in the clubroom.

Mr. Bew's Morse code competition prize was won by Mr. Warburton.

Oldham Lyceum Wireless Society.*

Mr. A. T. Holmes, of Manchester, lectured on "Amplifier Characteristics." He dealt non-technically with the problem of the best form and combination of different amplifiers.

Mr. I. P. Holden, Chairman, thanked the lecturer.

Manchester Wireless Society.*

Hon. Secretary, Mr. Y. W. P. Evans, 2, Parkside Road, Princess Road, Manchester.

A discussion was held on November 22nd on the various difficulties met with by the members in the reception of telegraphy and telephony. Much of the talk centred around the broadcasting transmissions, particularly with regard to the Manchester station, which, by general consent,

was considered of a very low standard, inasmuch that it could be received on all wavelengths, and was very detrimental to amateur transmitting experiments.

Friday, December 1st, Mr. Bertram Hoyle, M.Sc., lectured on "Radio Frequency Measurements."

The temporary arrangement of the circuit as used at the transmitting station for the transatlantic tests on Sunday, November 23rd, was replaced on December 2nd for a more efficient one by mounting the valves, switches, meters, etc., on a specially prepared panel measuring about six feet by eight, erected on insulators. This work was commenced on Saturday afternoon at 3 p.m., and completed at 11.30 p.m. A preliminary test was made to ensure the connections being O.K., and at 1 a.m. the final tuning of the set was carried out. Owing to a slight error in the transformer adjustment of the power valve filament one valve was burnt out and the spare valve had been loaned for exhibition. The spare valve arrived at 2.30 a.m. Meantime a test had been carried out on the one valve, resulting in excellent re-radiation, and this, coupled with the second, gave a fairly good output, which, by means of a few extra adjustments was increased considerably, and finally, at 5, 6 and 7 a.m., the set was worked at its maximum efficiency with the material in hand. The reception was very poor indeed owing to local conditions, with the result that only about three American amateur stations were heard. 8AQO (N.Y. District) was heard calling Manchester (5MS), but the reply was not answered, and experiments ceased at 7.30 a.m. Further tests will be made on December 24th and 31st.

Clapham Park Wireless Society.*

The fourteenth general meeting was held at headquarters, 67, Balham High Road, at 7.30 p.m. on Wednesday, November 29th, 1922.

Mr. A. E. Radburn was elected Chairman.

After the minutes of the last meeting had been read and corrected, the Hon. Secretary announced that he had received a letter of November 24th, 1922, notifying that the C.P.W.S. had been accepted for affiliation, and enclosing tickets of admission for members to monthly meetings.

After election of new members, Mr. Sinclair confirmed his arrangement to provide a speaker from the Radio Association on December 6th.

Mr. Oswald J. Carpenter, of the Marconi Scientific Instrument Company, was then called upon to give his promised lantern lecture, for which purpose the Hon. Secretary had secured the gracious loan of an arc lantern from Mr. Will Day of the Wireless establishment in Lisle Street, Leicester Square, and Mr. M. P. Prout, the Hon. Treasurer, had made all necessary structural alterations and fittings to install in readiness, Mr. Reitz kindly offering to operate lantern. Mr. Carpenter devoted the major portion of the evening to a discourse on "High Frequency Radio and Audio Amplification," with the aid of blackboard and chalk, answering several questions, and concluding the evening with a few lantern slides relating to popular wireless and Marconi history.

A hearty vote of thanks was accorded to Mr. Carpenter, also to Mr. Will Day for the loan of the lantern and sheet for projection purposes, which he graciously allowed the Hon. Secretary to collect

and deliver for the occasion. Also to Mr. F. H. Reitz, who proved himself a most capable operator, and to the Hon. Treasurer, who is such a valuable and material asset to the Society.

Birmingham Experimental Wireless Club.*

Hon. Secretary, Mr. A. Leslie Lancaster, c/o Lancaster Bros. & Co., Shadwell Street, Birmingham.

At the regular fortnightly meeting, held at Digbeth Institute, Birmingham, on December 1st, a very fine four-valve set was shown by the President, Dr. J. R. Ratcliffe. The set was home-made, but the workmanship throughout was very fine and was much admired. Excellent results were obtained, and a very interesting discussion ensued.

The next meeting was held on December 15th.

Hounslow and District Wireless Society.*

Hon. Secretary, Mr. A. J. Rolfe, 20, Standard Road, Hounslow.

Membership is increasing. A series of lectures has been arranged with well-known lecturers.

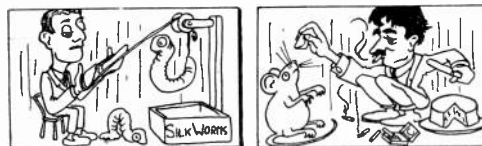
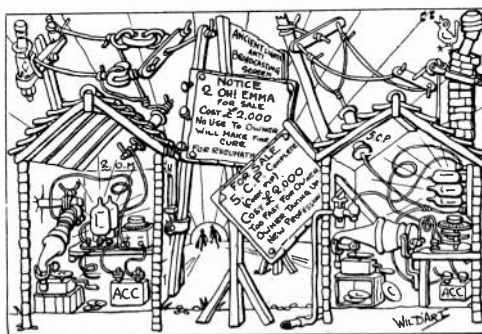

A hint from the Hounslow Society to 2 OM and 5 CP.

On November 9th, Mr. Sydney H. Nayler, lectured on "Wireless for the Beginner." On November 23rd, Mr. Emery lectured on "Constructional Details of a Tuned Set." On November 30th, Lieut. H. S. Walker lectured on "High Frequency Amplification."

A library has been started.

Fulham and Putney Radio Society.*

Hon. Secretary, Mr. J. Wright Dewhurst, 52, North End Road, West Kensington, London, W.14.

After the general business was disposed of on December 1st, Mr. Houstoun gave his experiences and described some wiring experiments he had made with the four-electrode valve. He promised to give a demonstration at an early meeting.

Mr. Calver described the results of trials he had made of various Armstrong circuits as published, and also he mentioned that he had wired up a new circuit which gave good results, and that at an early date he would let the members have full details.

The Society propose to hold a public exhibition and demonstration as soon as the necessary arrangements can be completed.

At a meeting on December 8th it was proposed that at future meetings visitors should be allowed

to take part in the discussions after the general business.

Mr. Calver brought in a very compact portable three-valve set.

Halifax Wireless Club and Radio Scientific Society.*

On November 22nd Mr. J. R. Halliwell of Manchester lectured on the 'amateur's position with regard to reaction and broadcasting. On November 29th the Treasurer, Mr. J. R. Clay, gave a paper on "The Armstrong Circuit."

An "Elementary Mutual Instruction Evening" was held on December 6th, the object being to provide a medium whereby those members lacking in experience might meet informally, those possessing more experience and profit thereby.

Mr. J. G. Jackson, B.Sc., of Sheffield, on December 13th, lectured on "The Electron."

Members joining after December 31st pay half subscriptions only.

Huddersfield Radio Society.*

Hon. Secretary, Mr. C. Dyson, 14, John William Street, Huddersfield.

On December 5th Mr. C. Dyson was Chairman owing to the unavoidable absence of the President.

Mr. George Newby, of the "Flactem Works," Halifax, gave an address on "Valves and Valve Circuits."

Mr. Newby, responding to a vote of thanks, said he would be very pleased to give another lecture in the New Year. The Hon. Secretary, Mr. C. Dyson, spoke on the subject of "Oscillating Valves," and asked everyone to assist in helping to prevent re-radiation. Three new members were enrolled.

Finchley and District Wireless Society.*

Hon. Secretary, Mr. A. E. Field, 28, Holnwood Gardens, Finchley, N.3.

A Carnival Dance was held on December 11th. The Society has now to change its club-room; this has upset arrangements, but it is hoped to put matters right by the New Year.

Attendance is dropping off. An appeal is sent to all members that they will attend as often as they can.

Stoke-on-Trent Wireless and Experimental Society.*

Hon. Secretary, Mr. F. T. Jones, 360, Cobridge Road, Hanley.

At a meeting on December 7th, the first portion of the multivalve receiver, which it was decided to construct, was assembled and tested, prior to being permanently mounted. British Broadcasting stations were clearly heard. One high frequency amplifying valve and a detector valve were used.

Hornsey and District Wireless Society.

Hon. Secretary, Mr. H. Davy, 134, Inderwick Road, Hornsey, N.8. Two meetings were held on November 27th and December 1st. Mr. H. J. Pugh was in the chair.

On the first occasion a "Dutch Auction Sale" took place. There was a large and varied collection of articles for sale. Everybody was satisfied, even the Treasurer.

Mr. C. R. Webster gave a demonstration with a two-valve set and loud speaker on December 1st.

Plymouth Wireless and Scientific Society.

Hon. Secretary, Mr. G. H. Lock, 9, Ryder Road, Stoke, Devonport.

Mr. E. W. Penney lectured on "Amplification," on November 28th, and on December 5th started a course of lectures which will be continued fortnightly and will probably last for six months. The whole range of wireless theory will be gone through.

Oxford and District Amateur Radio Society.

Hon. Secretary, Miss P. I. Thomas, 119, Iffley Road, Oxford.

The third meeting of the Society was held on November 31st, when Mr. R. W. Hardisty, of Trinity College, Oxford, was unanimously elected President.

The following is a list of the officers of the Society: Chairman, Mr. B. A. Canning; Treasurer, Mr. J. Pigott; Secretary, Miss Thomas; Committee, Messrs. V. Whitehead and Russell.

The Society is fortunate in having two gentlemen who hold the P.M.G. Certificate as Morse Instructors.

The Chairman announced that the necessary information had been forwarded to the Radio Society of Great Britain so that the affiliation with that Society might be completed.

Progress is rapidly being made with the Society headquarters, and by the New Year it is hoped to commence work in earnest.

The Secretary would be pleased to forward the Society rules to any lady or gentleman interested in wireless.

Wireless Society of Winchester.

Hon. Secretary, Mr. Albert Parsons, 65, Cromwell Road, Winchester.

The last three meetings have proved of great interest to the members, the first being in the form of a discussion opened by Mr. S. R. Humby on "The Principles of Wireless Telegraphy." Mr. Humby mentioned the work of bygone pioneers, Faraday, Maxwell, Hertz and others and Marconi.

The next topic was introduced by Mr. Earle, "The Construction of the Induction Coil." The lecture was appreciated by all present. The third event was a lecture on the "Microphone," by Mr. Gibbs, who kindly consented to take the place of Mr. Watson, who was to have lectured. Mr. Gibbs ably provided appropriate answers to questions.

Coventry and District Wireless Association.

Hon. Secretary, Mr. H. H. Thompson, 44, Northumberland Road, Coventry.

This Association has been revived. Permanent officers are elected and a definite programme arranged.

A general meeting was held at 128, Much Park Street, Coventry. It was then decided that a meeting should take place every Wednesday evening at 7.30 p.m., when business matters, lectures and other instructive items could be dealt with, and further, that the club-room should also be open every Tuesday evening for an informal gathering of members and friends, when the club's apparatus would be at their disposal. A receiving set specially constructed by members will soon be ready.

A "Questions and Answers" evening has been arranged.

On November 29th, the Chairman, advising a series of technical lectures, volunteered to give a lecture at least once each month.

It is proposed to give every assistance to members desirous of obtaining licences.

Northampton and District Amateur Radio Society.

Hon. Secretary, Mr. H. Barber, M.B.E., College Street, Northampton.

A lecture was given by Capt. Tissington on "Radio Transmission and Reception," on Monday, November 27th. He dealt with the theoretical side of his subject, from an elementary standpoint.

Questions were put into the question box, to be dealt with at a "Question and Answers Night."

Morse classes under Capt. Tissington and Mr. F. Turville were arranged.

On December 4th, at the Exchange Assembly Rooms, Mr. J. Reid presiding, a lecture entitled "Elementary Principles of a Single Valve Set" was given by the Vice-Chairman, Mr. A. E. Turville, who devoted himself mainly to the instruction of members who had little or no experience in wireless experiment.

After discussion, the lecturer connected up the apparatus referred to, and demonstrated by receiving music from Birmingham and London, using an indoor aerial. There were 70 members present.

Radio Society of Birkenhead.

Hon. Secretary, Mr. R. Watson, 35, Fairview Road, Oxtou, Birkenhead.

The second general meeting took place on December 7th. At the buzzer class held by Mr. McKinlay, about eighteen members attended. One lady member was present.

Mr. Hughes occupied the chair. Mr. Waygood lectured on "Transformers." Telephony from 2 ZY was received on Mr. Austin's set. Another meeting was held on the 21st, when Mr. A. P. Hill lectured on "Continuous Waves and their application to Telegraphy and Telephony."

Kingston and District Radio Society.

Mr. J. C. C. Berry, 57, High Street, Hampton Wick.

At a meeting on December 7th Mr. Carpenter tendered his resignation as Secretary owing to pressure of business.

Mr. J. C. C. Berry was unanimously appointed as Secretary, and a ballot was taken when Mr. F. P. Sexton was elected President with a Committee of five.

It was decided that steps be taken to affiliate with the Radio Society of Great Britain, and a programme of lectures and demonstrations be drawn up beginning with a lecture on "The Selection of an Aerial System," by Mr. R. Older.

The Headquarters of the Society are at 45, Surbiton Road, Kingston-on-Thames (entrance in Southsea Road).

Manx Radio Society.

Hon. Secretary, Mr. J. P. Johnson, 16, Hildesley Road, Douglas, I.O.M.

This Society was inaugurated at a meeting held at 19, Hawarden Avenue, Douglas. The following officers were elected:—Chairman, Mr. H. Colebourn; Secretary, Mr. J. P. Johnson; Committee, Messrs. Vick, Gelling, Downward, Axon, Craine, and Hinton.

The Committee was instructed to formulate a policy, frame rules, enquire for suitable quarters, and report to a general meeting to be called as soon as practicable.

Sunderland Wireless and Scientific Association.

Hon. Secretary, Mr. A. Richardson, Westfield House, Sunderland.

A lecture was given on December 16th by Dr. J. A. Wilcken on "Propagation of Electro-Magnetic Waves."

The Association is now situated at Westfield House.

Malvern Wireless Society.

Hon. Secretary, Mr. N. H. Gwynn Jones, Burford House, Worcester Road, Malvern.

On November 29th Mr. N. H. Gwynn Jones lectured on "Electrostatics and Condensers."

A vote of thanks was accorded the lecturer.

On December 20th a public demonstration took place at the Society's headquarters. The occasion marked the welcome of Mr. Dyson Perrins as President of the Society. A silver collection was made on behalf of local charities.

Walthamstow Amateur Radio Society.

Hon. Secretary, Mr. R. H. Cook, 49, Ulverston Road, Walthamstow, E.17.

The Society's three-valve set with loud speaker was used on November 22nd to demonstrate broadcasting reception by Mr. Webb. Very good results were obtained, the set working splendidly.

On November 29th the evening was spent on the general business of the Society for the month, and a discussion on "High and Low Frequency Amplification." The discussion was opened by the President, Mr. Allen. Several members gave their experiences with both circuits, and much useful knowledge was gained by the other members present. An elementary class has been formed and started on December 6th, Mr. Cook acting as lecturer and demonstrator.

Hull Technical College Wireless and Scientific Club.

Hon. Secretary, Mr. W. R. Bingham, 46, Auckland Avenue, Newland, Hull.

A new club was formed on November 7th in the Hull Technical College. There were about 30 students present. Capt. W. E. Dennis was unanimously elected President; Mr. Perkins, Chairman; Mr. W. R. Bingham, Hon. Secretary; Mr. Mould, Treasurer. It was proposed that the President should write to the Postmaster-General for an experimental licence by which a number of interesting experiments could be performed with a set kindly lent by Capt. Dennis. On November 14th Mr. Perkins lectured on "Induction Coils." Capt. Dennis gave one on November 21st on the "Construction of a Spark Transmitter," and Mr. Reeder gave another on November 28th on "Wave Motion." A hearty vote of thanks was passed for the lecturers.

Redditch and District Radio Society.

Hon. Secretary, Mr. A. W. Reeves, The Elms, Alvechurch, near Redditch.

At a meeting on December 1st, at the Temperance Hall, Redditch, details of the proposed installation of a two-valve receiver were again discussed. The outside equipment has been erected.

The Society has about 25 members. Lectures are being arranged. Morse practice is carried out. A public demonstration was arranged for December 13th.

Experimental Transmissions in the London Area.

TWO meetings have been held recently to discuss the situation with regard to experimental transmissions in the London area. These meetings were convened by the Radio Society of Great Britain (late Wireless Society of London). The first meeting was held at the Institution of Electrical Engineers, when a committee composed of the following gentlemen was appointed to consider the question and prepare a report:—

Major H. Hamilton, D.S.O., Major H. C. Parker, Captain R. Tingey, Mr. M. Child, Mr. H. S. Walker, Mr. W. K. Alford, Mr. O. J. Carpenter, Mr. F. Phillips, Mr. L. McMichael (*Hon. Secretary*).

The report was submitted at a further meeting held at the Waldorf Hotel on November 13th, when the decisions arrived at by the Committee were all accepted by the meeting, at which there were about 80 transmitting licence holders present.

The decisions arrived at with regard to experimental transmissions were as follows:—

(1) It is agreed that a voluntary arrangement to be made to stop broadcast music except where special permission has been obtained from the G.P.O. in which case this should be stated before, during, and after the transmissions. Music transmissions (either gramophone or otherwise) not exceeding five minutes in duration

to be permitted for testing purposes, and a total transmission at one time of not more than ten minutes—with a total transmission of four such periods (40 minutes) in all, during any one evening from 6 to 11 p.m.—other hours of the day being free except that the five minutes limit of music transmission shall apply.

(2) These arrangements only to apply to working on the 440 metre wavelength.

(3) Holders of transmitting licences are reminded of the terms of their licence whereby they must use their call sign before and after each transmission.

(4) The use of spark transmissions by amateurs on all wavelengths should be abolished and tonic train on 440 metres wavelength.

Major Hamilton further proposed that a Committee be formed to assist those using experimental transmitting licences, and to generally consider matters affecting them. This Committee to be a sub-Committee of the Radio Society of Great Britain. It was suggested that the Committee be composed of three persons holding high power transmitting licences, three holding small power transmitting licences, and three holding receiving licences, and that out of these nine members not more than three should be engaged in the trade.

Notes

R.A.F. Wireless Officers' Reunion Dinner.

Group-Captain Warrington Morris presided over the annual gathering of officers and ex-officers of the R.A.F. Wireless Training School, held at the Holborn Restaurant.

Speaking of the vital importance of wireless communication in modern warfare, Wing-Com-

enthusiasm shown by the average amateur experimenter. Such men were a credit to the country and their skill and experience would form a national asset in time of need.

Any ex-officers of the school who may desire to attend the next reunion should communicate with the Commandant, at Flowerdown, Winchester.

Port Elizabeth Wireless Development.

The Port Elizabeth Chamber of Commerce is booming wireless telegraphy and telephony in South Africa, says the *British and South African Export Gazette*. Negotiations for the installation of a wireless telephone broadcasting station for disseminating commercial information are well advanced. Meanwhile, interest in wireless in both the Union and Rhodesia grows apace, and such organisations as the Wireless Section of the South African Institute of Electrical Engineers, the Radio Society of South Africa, and a Wireless School recently opened in Bulawayo, are educating the public to the uses of the science.

Duty on Apparatus for South Africa.

Wireless telegraph apparatus, including broadcasting sets, on entering the Union of South Africa, is subjected to duty of 20 per cent. *ad valorem*. A rebate of 3 per cent. is allowed in the case of British goods.

Reception of American Broadcasting Stations.

Reports of Reception of Telephony from American Broadcasting Stations are so numerous that it has not been possible to analyse them for publication in this issue. Details will be given as early as possible.

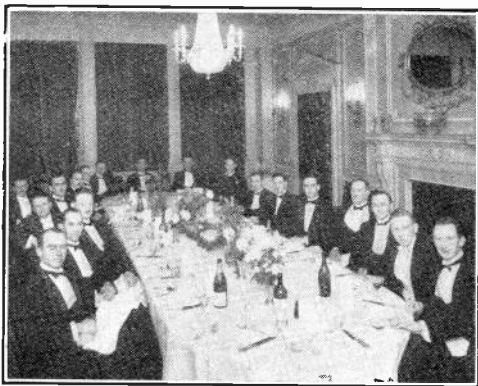

A Royal Air Force Wireless Function.

mander J. B. Bowen paid a warm tribute to the work at present being done in Mesopotamia by the wireless personnel, frequently in the teeth of overwhelming difficulties.

He welcomed the advent of broadcasting, and was particularly impressed by the extraordinary

Correspondence

To the Editor of THE WIRELESS WORLD AND RADIO REVIEW.

SIR,—I am sending you the enclosed photograph of a three-valve amplifier, constructed from details given by Mr. Bull in *The Wireless World and Radio Review* lately. It is made exactly to the instructions, and works very well, two valves being sufficient for the present broadcasting on M-O "R2" detecting, and M-O "R1" L.F. amplifying.

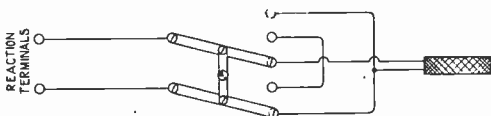

A switch mounted on top of coil holders.

There is one addition, that is the switch mounted on the top of the coil holders; it is inserted between the reaction terminals and reaction coil; it is a double pole switch with both blades linked together; it enables the current in the reaction coil to be reversed and also to cut the coil out if required, instead of the link as suggested in Mr. Bull's article. Above is a rough sketch of the connections.

W. H. DENNIS.

Goodmayes, Ilford.

Book Review

DIRECTION AND POSITION FINDING BY WIRELESS.
By R. Keen, B.Eng. (Hons.). London: *The Wireless Press, Ltd.*, 12/13, Henrietta Street, W.C.2. Illustrated. Price 9s. net.)

The subject of wireless direction finding has had up to the present but scanty attention paid to it by writers of text-books. This is, no doubt, chiefly because its specialised nature requires more than a general acquaintance with the methods and practice of the art. The writer of the present book has evidently had not only a very thorough practical experience of the technicalities of the subject, but has spent considerable time in pondering over its theoretical aspects and in acquiring detailed knowledge from original sources of the progress in this branch of wireless telephony.

The book contains eleven chapters very clearly printed and arranged, and is illustrated with 254 excellent diagrams and photographs. An introduction of an historical nature is followed by a treatment of the theory of direction finding. In this chapter and from henceforward, though not neglecting to explain and briefly describe the other systems, the author pays special attention to the Bellini-Tosi system of direction finding as developed by the Marconi Company, and in three later chapters which respectively describe ship, shore and aircraft installations, very full details are given of this Company's apparatus for these three pur-

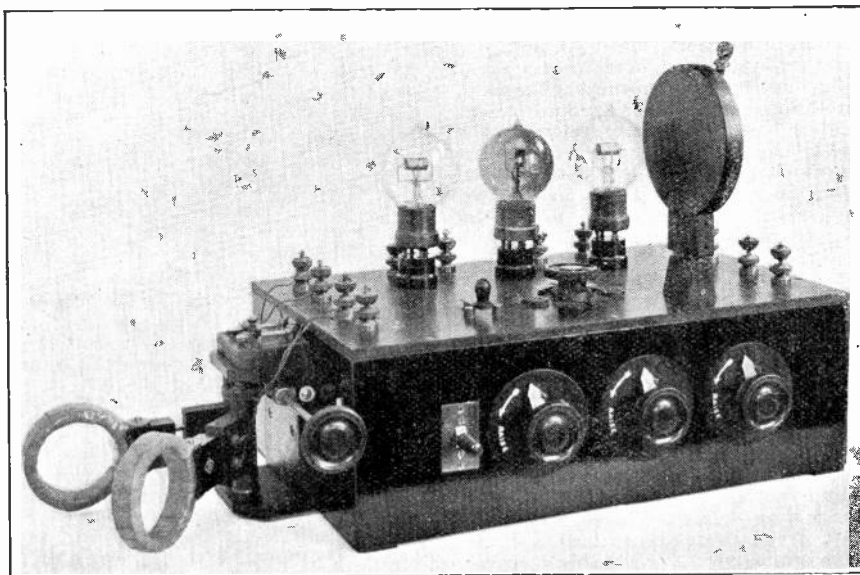

A Three-valve Amplifier constructed from details given in an article published in this Journal by Mr. A. J. Bull (p. 677, issue August 26th).

Books Received

DISCOVERIES AND INVENTIONS OF THE TWENTIETH CENTURY. By Edward Cressy. Second edition. (London: George Routledge & Sons, Ltd. Price 12s. 6d. net. 458 pp. 8½ by 6".)

poses. This chapter is followed by one on the fault-clearing and maintenance of D.F. sets employing the Bellini-Tosi system.

A chapter on maps discusses the use of specially prepared charts (e.g., the gnomonic projection) for the simplification of the plotting of bearings, and

also shows clearly how the Mercator's projection may be employed without error for this purpose. This is followed by a chapter on Position Finding, which gives much interesting and useful information on the use of direction finders on ships and on shore as a means of navigation. Here, as in other parts of the book, the author makes free use of illustrations and of numerical examples to assist his description. With these chapters the last in the book entitled "Notes on Field and Nautical Astronomy" may be conveniently classified. It contains complete explanatory instructions with examples for solving a number of practical problems in navigation and survey work by astronomical methods. The information in these three chapters is extremely useful from the point of view of D.F. work existing as it has up to the present only in scattered form throughout many different publications. Chapter 6 is devoted to the discussion of the freak errors occurring in practice, especially of those known as "Night Effect."

As regards the matter contained in the book there is very little to criticise. The author seems to suggest throughout the book, however, and notably on page 49, that the rotating frame systems are recognised inferior as practical working systems to the Bellini-Tosi system, thus giving a somewhat false impression of the actual state of affairs. For, at the present time the rotating coil D.F. system is probably used on a larger scale than the Bellini-Tosi system; while from all other points of view it is quite an open question as to which of the rival systems is the best. By specialising to such an extent on the Bellini-Tosi system the author has enabled his book to fulfil the dual function of a general text-book and of a handbook on this system for operators and engineers. It cannot but be regretted, however, that more attention has not been paid to similar descriptions of the rotating frame systems. The very complete bibliography, upon which the author is to be congratulated, would have supplied some information on this matter, and the book would probably have gained in breadth of interest by sacrificing the chapter on valve amplifiers for a detailed description of, say, the American Navy apparatus.

In his chapter on "Night Effect," the author shows himself to be a staunch advocate of the "Heaviside-Layer" theory. By means of close reasoning and a number of diagrams he shows clearly how the phenomena of signal fading and variations of bearing of any extent can be explained by means of the downward reflected ray from this hypothetical layer. Several methods are indicated which avowedly eliminate night errors, the most interesting—and the one to which most attention is paid by the author—being the ingenious method due to G. W. Wright, which produces a heart-shaped polar reception curve. Even this, however, is not claimed to constitute a practical method of direction finding, and the satisfactory solution of the problem appears still to be undiscovered.

In conclusion the author has undoubtedly produced a thoroughly well-written book, and one for which there was much need, and no serious student of modern direction finding can afford to be without this extremely reliable guide.

R. L. SMITH-ROSE.

Calendar of Current Events

Friday, December 22nd.

WIRELESS SOCIETY OF HULL AND DISTRICT.
At 7.30 p.m. At Signal Corps Headquarters, Park Street. Questions and Answers.
LEEDS AND DISTRICT AMATEUR WIRELESS SOCIETY.
Dinner.

Sunday, December 24th.

3-5 p.m. *Daily Mail* Concert from PCGG,* The Hague, on 1,050 metres.

Monday, December 25th.

9.20-10.20 p.m. Dutch Concert, PCGG,* The Hague, on 1,050 metres.

Thursday, December 28th.

At 9.20-10.20 p.m. Dutch Concert from PCGG,* The Hague, on 1,050 metres.

HACKNEY AND DISTRICT RADIO SOCIETY.
Informal meeting.

DERBY WIRELESS CLUB.
Informal meeting.

ILFORD AND DISTRICT RADIO SOCIETY.
Lecture by Mr. E. E. Hale on "Current Supply for Valves."

Friday, December 29th.

BRADFORD WIRELESS SOCIETY.
At 5, Randallwell Street, Bradford. Annual Meeting.

CHRISTMAS PROGRAMMES.

At the time of going to press no special arrangements had been made by those responsible for broadcasting with regard to the Christmas holidays.

A New Store.

Pettigrew and Merriman, Ltd., 122-124, Tooley Street, S.E.1., announce that they are opening a retail store and demonstration room at 54, Gracechurch Street, E.C.3. A technical wireless engineer will be in attendance to give advice.

Dutch Reception of 8 GS.

Mr. K. C. Van Ryn, Delft, Holland, reports having received 8 GS (200 metres) very clearly up to 25 metres from the telephones on a five-valve set (two H.F. and two L.F.).

Reception by Crystal at 180 Miles.

Mr. Maurice A. R. Horspool, Hon. Secretary of the Wireless and Scientific Society of Bridlington, reports that he has received 2 LO on a crystal receiver at a distance of 180 miles. The receiver was made by the Wainwright Manufacturing Co., Ltd. Brown's phones were used, and the crystal was Silicon.

British Amateurs heard at Nice.

Reception of the following British Amateurs is recorded by M. Léon Deloy (8 AB), of the Radio Club de la Côte D'Azur, Nice:—2 FQ; 2 OM; 2 CV; 2 ON; 2 DM; 2 JZ; 2 KF; 2 OD; 2 FP; 2 XI; 2 AW; 2 LG; 5 MS; 2 KV; 2 NM. All these stations were received on a single valve with the exception of 2 FQ. At the time 2 FQ was received three low frequency valves were being used after the detector and signals could be heard ten metres from the telephones.

* At the time of going to press the transmissions from PCGG were expected to take place as usual during the holidays.

The Transatlantic Tests

By PHILIP R. COURSEY, B.Sc., F.Inst.P., A.M.I.E.E.

AT the time of writing, reports are just beginning to arrive of the receptions of the American transmissions during the first night of the Transatlantic Tests. Reports have already been received from several parts of this country and also from Holland showing that several U.S. amateurs have "got over," their signals with the special code words allotted to them having been received and verified by the copy of the transmission schedule which was sent to the Radio Society of Great Britain by the American Radio Relay League.

The text of the first report transmitted by Carnarvon on December 13th, at 0700 G.M.T. is as follows:—

Text of Radiogram sent to the American Radio Relay League, December 13th, 1922, at 0700 G.M.T.

To: SCHNELL RADIOPORP NEWYORK

FOLLOWING HEARD DECEMBER TWELFTH CODES AND TIMES CORRECT ONE
BOY GEORGE FOX ONE YOKE KING TWO EASY LOVE TWO GEORGE KING
TWO NAN ZED TWO XRAY ABLE PUP TWO ZED KING TWO ZED LOVE THREE
ZED WATCH EIGHT ABLE QUACK OBOE EIGHT ABLE WATCH PUP STOP FREE
FOR ALL TWO BOY MIKE LOVE TWO LOVE YOKE TWO NAN ZED TWO ZED KING
THREE BOY GEORGE TARE THREE HAVE GEORGE THREE ZED YOKE FOUR
FOX BOY FOUR OBOE ITEM FOUR ZED SAIL FOUR ZED WATCH STOP FOLLOWING
NOT TO SCHEDULE TWO ZED SAIL THREE XRAY MIKE FOUR BOY XRAY FOUR
OBOE ITEM SEVEN PUP OBOE EIGHT GEORGE QUACK STOP ALSO PHONE TWO
ZED KING STOP CONGRATULATIONS — COURSEY

This indicates that during the "Individual transmission" periods signals complete with correct code letters were picked up from the following U.S. stations:—

1 BGF; 1 YK; 2 EL; 2 GK; 2 NZ; 2 XAP; 2 ZK; 2 ZL;
3 ZW; 8 AQQ; 8 AWP.

And also that during the "free-for-all" transmission periods the following stations were heard, signalling "Test, Test, Test" at their correct times in accordance with the prearranged schedule:—

2 BML; 2 LK; 2 NZ; 2 ZK; 3 BGT; 3 HG; 3 ZY; 4 FB;
4 OI; 4 ZS; 4 ZW.

Calls from the following stations were also reported, but have not been verified by the schedule. The stations concerned were, however, probably engaged in their ordinary routine traffic communication:—

2 ZS; 3 XM; 4 BX; 4 OI; 7 PO; 8 GQ.

One receiver in this country also reported hearing 2 ZK, using his radiophone transmitter, followed by the "Test" calls and his code letters in Morse.

This report for the first day's reception tests shows a very marked improvement as compared with last year's Tests, as was to be expected in view of the many reports that have been received lately of the reception of U.S. amateur signals in this country, as well as the reception of American broadcasting stations.

Further reports of receptions during the remainder of the Tests will be published in these columns in due course.

Questions and Answers

NOTE.—This section of the magazine is placed at the disposal of all readers who wish to receive advice and information on matters pertaining to both the technical and non-technical sides of wireless work. Readers should comply with the following rules:—(1) Each question should be numbered and written on a separate sheet on one side of the paper, and addressed "Questions and Answers," Editor, THE WIRELESS WORLD AND RADIO REVIEW, 12/13, Henrietta Street, London, W.C.2. Queries should be clear and concise. (2) Before sending in their questions readers are advised to search recent numbers to see whether the same queries have not been dealt with before. (3) Each communication sent in to be accompanied by the "Questions and Answers" coupon to be found in the advertisement columns of the issue current at the time of forwarding the questions. (4) The name and address of the querist, which is for reference and not for publication, to appear at the top of every sheet or sheets, and unless typewritten, this should be in block capitals. Queries will be answered under the initials and town of the correspondent, or, if so desired, under a "nom de plume." (5) In view of the fact that a large proportion of the circuits and apparatus described in these answers are covered by patents, readers are advised before making use of them, to satisfy themselves that they would not be infringing patents. (6) Where a reply through the post is required every question sent in must be accompanied by a postal order for the amount of 1s., or 3s. 6d. for a maximum of four questions. (7) Four questions is the maximum which may be sent in at one time.

"W.R.H." (Oldham) asks (1) For criticism of his set. (2) The values of the condensers connected across the L.F. transformers. (3) The best turn ratio for L.F. transformers.

(1) The proposed arrangement is suitable, but you would probably secure louder signals if the valves were connected, 1 H.F., 1 detector, and 1 L.F. The switching arrangement is correct, although the valves not in use will still have their filaments connected with the L.T. battery. The switching arrangement shown on page 886, September 30th issue, should help you, and we think you cannot do better than adopt this scheme yourself. (2) The fixed condensers have a value of 0.001 mfd., and are necessary for good operation. (3) The turn ratio of the L.F. intervalve transformer should be 2 or 3 to 1.

"W.A.W." (Hull) asks for a design of a four-valve resistance capacity coupled circuit.

See Fig. 1. Suitable values are marked in. You would find "R" type valves quite suitable. The amplifier will only be suitable for reception on wavelengths above 2,000 metres.

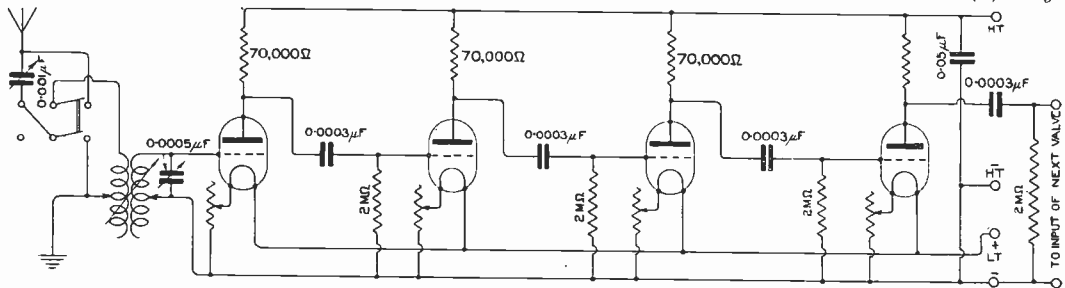

Fig. 1.

"C.F.W." (Windsor) asks whether coils No. 1,000 and 750 may be used in place of the 1,500 and 1,250 turns coils mentioned in the description of the Armstrong super-regenerative circuit in a recent issue.

You may try, but it is always better to follow out the writer's instructions precisely, at least, until a good working knowledge of this class of circuit is obtained.

"W.J.T." (E.17).—The value of resistance R_1 is about 2,000 ohms, and R_2 5,000 ohms. The voltage of battery B is roughly 100 volts, or the same as B_2 .

"G.E.B." (Manchester) asks (1) For particulars of intervalve and telephone transformers. (2) Where a connection from the condenser in a diagram on page 43 is taken to. (3) Questions about reaction. (4) The resistance per yard of No. 36 Eureka wire.

(1) The construction of an intervalve transformer was described in the issue of August 19th. The telephone transformer may be made as follows:—Coil of iron wire, $\frac{1}{2}$ " diameter and 3" long; primary winding, 3 ozs. of No. 44 S.S.C.; Secondary winding, 4 ozs. of No. 34 S.S.C. (2) The connection is taken from the condenser to the end of the transformer which is connected to + H.T. (3) We do not advise you to adopt the proposed arrangement. If you couple the reaction coil to the anode circuit of the first H.F. valve, reaction effects can always be obtained. (4) 14.8 ohms per yard.

"F.B.T." (E.11) asks (1) For a good two-valve circuit for telephony. (2) What is the best form of inductance for short wave work. (3) Why

the Post Office only allow 100 ft. of wire to be used in a single wire circuit.

(1) See diagram on page 841, September 23rd issue. (2) Without doubt the most efficient coils for short wave work are single layer coils. (3) The Post Office limits the length of a single wire aerial to 100 ft. in order to reduce the evil effects of radiation when experimenters accidentally set up oscillations in the aerial circuit. The P.O. may however, grant permission for the use of a longer aerial for the purpose of carrying out specific experiments.

Convince yourself

on the quality and supreme merits of the

MAGNAVOX

The World's Finest Loud Speaker

by paying a visit to our showrooms and hearing its voice. Demonstrations given daily. See our exclusive and extensive range of radio apparatus.

To be obtained from all dealers or direct from the
Manufacturers & Sole Licensees

Sterling Telephone & Electric Co., Ltd.

210/212, Tottenham Court Road, London, W.1

Telephone No. : 4144 Museum (7 lines) Telegrams : "Cucumis, Wesdo, London."

Works : DAGENHAM, ESSEX.

BRANCHES : NEWCASTLE-ON-TYNE : 9, Clavering Place.
CARDIFF : 8, Park Place.

We guarantee that all Broadcast Radio Apparatus sold by us conforms with the conditions of the Broadcaster's Licence issued by the Postmaster-General.



No. R1282

RADIO brings it.
MAGNAVOX tells it.

TOMLINSON

LONDON, LIMITED.

Demonstrations
Daily.

3, FINCHLEY RD., ST. JOHN'S WOOD, N.W.8
Hampstead 1844

Demonstrations
Daily.

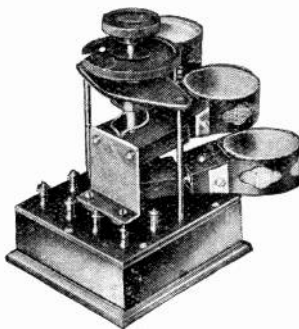

THREE-COIL HOLDER.

A New 3-Coil Holder

After considerable experimental work we have produced a Three-Coil Holder which combines extreme efficiency, neat appearance, easy adjustment and low cost.

In order to introduce this splendid instrument we are prepared to sell a limited number at the extremely low price of

20s.

Postage 9d.

Have you had your copy of our illustrated
Catalogue?—2d. post free.



HEADPHONES

(British Made) £1
4,000 ohms.
Postage 9d.

BRITISH and BEST

To obtain the best results from your Receiving Set it is essential to use the best 'phones



The "BROWN" Super-Sensitive Telephone Receiver Type A

OF the many recent developments in Wireless Telegraphy, the "BROWN" Type A Telephone is unquestionably one of the most valuable, inasmuch as without modifications to existing installations, the range is much increased and signals difficult to detect with the use of the usual telephonic receivers are clear and distinct when these instruments are employed.

Tests recently made have shown the "BROWN" Telephone to possess an efficiency of three times that of other telephonic headgears.

Their extreme lightness and ease of adjustment make them the most comfortable of all headphones to wear.

	PRICE: Type A (with Cords).	The Pair.
120 ohms	£2 18 0
Over 120 ohms to 4000 ohms	3 2 0
4000 ohms to 8000 ohms	3 6 0

Carriage Paid in U.K.

TYPE D. Recommended for Wireless Telegraphy or for ordinary telephone work in which the extreme sensitiveness of Type A is not essential. These headphones under our tests have shown an efficiency and clearness of speech greater than any other Receiver of this type.

	PRICE (with cords).	
120 ohms, the pair	£2 8 0
Over 120 to 4,000 ohms, the pair	2 12 0

Carriage Paid U.K.

*In universal use. Supplied to British and Foreign Governments.
Illustrated Catalogue of our Headphones, Loud Speakers and Amplifier post free from—*

S. G. BROWN, Ltd.

London Offices
and Showrooms

19, MORTIMER ST., LONDON; W.1

TRADE COMMUNICATIONS ONLY TO—

HEAD OFFICE AND WORKS: VICTORIA ROAD, NORTH ACTON, LONDON, W.3.

Telegrams—"Lidbrownix, London."

Telephone—Chiswick 1469.

Sole Agent for the Argentine—Horacio D. Guerrero, Las Heras, 2486, Buenos Aires.

"R.A.B." (Bristol) asks (1) For a two-valve circuit employing H.F. amplification. (2) Whether a loss of signal strength results from coupling the reaction coil to the H.F. transformer instead of the aerial circuit. (3) Are better results possible from a 3-coil holder than from a 2-coil holder when a single valve is used. (4) For a diagram showing the connections of a 3-coil holder to a single valve.

(1) See Fig. 2. (2) A loss of efficiency will not result, as explained in several previous issues of our journal. (3) Better results are possible since tuning adjustments may be finer, and it is

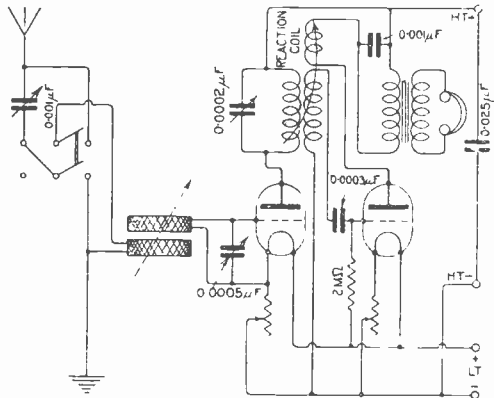

Fig. 2.

possible to obtain a voltage step-up from the aerial to the closed circuit. (4) See Fig. 3. This circuit however, is not to be recommended since it is so easy to set up oscillations in the aerial circuit—to the annoyance of your neighbours who may be listening-in.

"A.F.W.M." (Portsmouth).—To receive broadcast transmissions you will require a small coil of No. 22 D.C.C. wire. The former may be 3" diameter and 4" long, and 8 windings should be taken off one end, then take a tapping off at every eighth turn.

"R.C." (Harrow) asks (1) Whether diagram submitted is correct. (2) If we can suggest improvements. (3) Whether he should hear broadcasting transmissions. (4) Suitable values of L.T. and H.T. for "Ora" type valve.

(1) and (2) The proposed arrangement will not give signals, because the grid filament circuit is shunted with a condenser. Several diagrams have recently been given indicating the correct method of connecting a crystal detector and an L.F. valve. (3) We think you should, provided the set is properly wired. (4) Use 6 volts L.T. with a filament resistance of about 7 ohms. The H.T. may be 45 volts.

"J.W." (Romford) (1) Submits a diagram of his set and asks for a criticism. (2) Dimensions of loose coupler to tune from 100 to 2,000 metres. (3) Values of condensers. (4) Dimensions of anode inductance and reaction coil.

(1) The proposed arrangement is satisfactory, but you would be able to use fewer switches by adopting the switching scheme shown on page 883, September 30th issue. (2) The aerial coil should be a winding of No. 22 D.C.C. wound on

a former 4" diameter and 6" long, with 10 windings. The closed circuit coil may be a coil of No. 26 D.C.C. wound on a former 3½" diameter and 6" long with 6 windings. A switch to connect the A.T.I. and A.T.C. in series or parallel will prove of great help. (3) The A.T.C. = 0.001 mfd. maximum, C.C.C. = 0.0005 mfd. maximum, grid condenser = 0.0003 mfd. fixed. By-pass condensers are 0.001 mfd. fixed. H.T. battery by-pass condenser has usually a capacity of from 0.01 mfd. up to 0.5 mfd. The anode tuning condenser may have a maximum value of 0.0002 mfd. (4) The anode coil may consist of a winding of No. 32 D.C.C. on a coil 2½" diameter and 5" long, with 10 windings, and the reaction coil 100 turns of No. 38 S.S.C. on a former 3" diameter.

"FILAMENT" (Penarth) asks (1) For criticism of set, diagram of which is submitted. (2) Whether the capacity of a Dewar switch will seriously affect results when connected in the H.F. circuit. (3) Whether cleaning his aerial will increase its efficiency.

(1) The proposed arrangement is very suitable indeed, and the wiring is quite correct. (2) We think you will find no serious losses occur if the components of the switch are well spaced. Such switches, however, are expensive, and you may prefer to use small double pole throw-over switches, which are quite satisfactory and relatively cheap. (3) You could, of course, haul down the aerial and clean it, but the increase in efficiency will probably not be noticeable. It is better to employ stranded enamelled conductors when the aerial is so situated that corrosion quickly takes place.

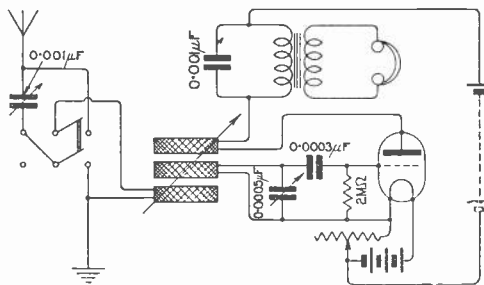

Fig. 3.

"W.P." (Seven Kings).—H.F. transformer design is explained in the issues of September 2nd and 16th. If you wish to wind the cylindrical H.F. transformer for 300-450 metres described on page 717 of September 2nd issue, wind 450 turns of No. 40 S.S.C. copper wire on a cylindrical former 1½" diameter. The windings are both wound in the same direction, and the leads which terminate at one end are connected with grid and plate.

"BEGINNER" (Walthamstow) asks us to provide a wiring diagram for a panel which he proposes to place on the market; whether any patents are infringed, and what action to take with the Post Office.

We cannot undertake to provide this information. This section of the journal is devoted to the needs of amateurs and experimenters. See the note at the head of this section.

"H.S." (Stretford).—We suggest you construct the H.F. transformer described in the issue of September 23rd, page 828. The wavelength range of this transformer, when using a 0.0001 mfd. tuning condenser, is from 350 to 1,000 metres. If you desire to use plug-in type H.F. transformers for all wavelengths, we suggest you wind seven transformers, using ebonite formers $2\frac{1}{4}$ " to 3" outside diameter, with a groove $\frac{1}{8}$ " to $\frac{1}{4}$ " wide and $\frac{1}{8}$ " to $\frac{1}{2}$ " deep, winding the following turns:—50, 100, 250, 400, 650, 1,000 and 2,500 turns. The primary and secondary windings should have equal turns.

"PERPLEXED" (Forest Gate) asks (1) Whether the tuned anode method of coupling is suitable for use over all wavelengths. (2) For a circuit using 2 H.F., 1 detector, and 1 L.F. valves with arrangements for cutting out valves.

(1) The tuned anode method of high frequency amplification is suitable for use over all wavelengths. On short wavelengths the tuning condenser should have a maximum value not exceeding 0.0002 mfd., but on the longer wavelengths this condenser may conveniently have a maximum value of 0.0004

"H.W.A." (Cheltenham).—The Armstrong super-regenerative circuit is specially intended for use on a frame aerial, and if used on an outside aerial would cause serious interference with other experimenters. The values given for the various components in the description which appears in our issues of October 21st and 28th are especially applicable for use with a frame aerial, and if you intend to use this apparatus with an outside aerial for experimental purposes, you will have to make a number of tests for yourself to determine the necessary values for the components. Several descriptions of the Armstrong super-regenerative circuit have appeared in our issues for many weeks past, and most of the circuits given make use, of course, of only two valves. The set described by Mr. Harris in our recent issues has a note magnifier in order to extend the range of its use as advocated. We understand that the Post Office will not sanction the use of the Armstrong circuit on Broadcasting wavelengths even when connected to a small frame aerial.

"F.G.S." (Hornsey).—The A.T.I. of the transmitter could consist of a coil 40 turns of No. 16

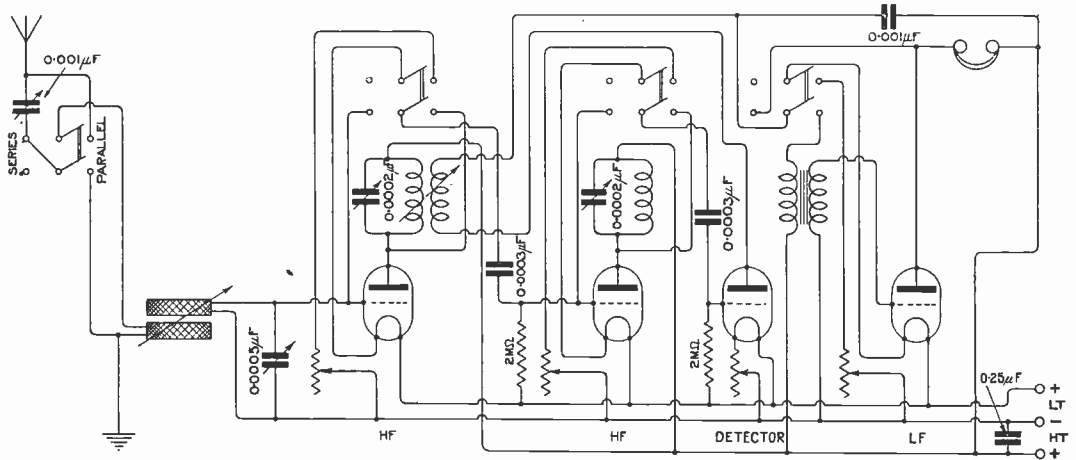

Fig. 4.

mfd. (2) See Fig. 4. As you have not submitted particulars of the switches you propose to adopt in this circuit, we have shown ordinary double pole throw-over switches connected.

"R.H.M." (Shepherd's Bush).—The anode reactance should have a value of about 70,000 ohms, and should be capable of carrying a current of a few milliamperes. The proposed arrangement is quite suitable, but it will probably not be necessary to use cells in the grid of the first valve. A potentiometer is not essential, but you would find one useful to control the potentials of the grid of the H.F. valve. The anode voltage should be much higher when resistances are in the anode circuit, and we suggest 65 volts as a suitable value, and 6 volts for the filament. The apparatus does not conform with the P.O. regulations. When receiving on short wavelengths the reaction coil should be coupled with the secondary of the H.F. transformer. When you wish to receive long wavelengths, the arrangement proposed is quite suitable.

D.C.C. wire wound on a former 5" diameter and 8" long. We suggest you take tappings at every eighth turn, and also take a few tappings at every other turn at the aerial end of the inductance. The reaction coil may consist of 80 turns of No. 22 D.C.C. wire wound on a former 4" diameter. You will probably have to experiment a little and find the best value of reaction coupling.

"W.T." (Holloway).—The proposed arrangement is correct. The fixed condensers have the following values:—

20 foils $2\frac{1}{2}$ " \times $1\frac{1}{4}$ " mica 0.002" \times 0.053 mfd.

6 foils $1\frac{1}{2}$ " \times 1" mica 0.002" \times 0.0079 mfd.

3 foils $1\frac{3}{4}$ " \times 2" mica 0.002" \times 0.0032 mfd.

The 0.001 mfd. fixed condenser may consist of 3 foils with an overlap of 1 " \times $\frac{1}{2}$ " mica 0.002" thick. The 0.0005 mfd. fixed condenser may consist of 3 foils $1\frac{1}{4}$ " \times $\frac{1}{2}$ " with mica 0.002" thick. The above are the theoretical values, and will not be correct unless the plates of the condenser are held very tightly together so that the dielectric may be considered as all mica.

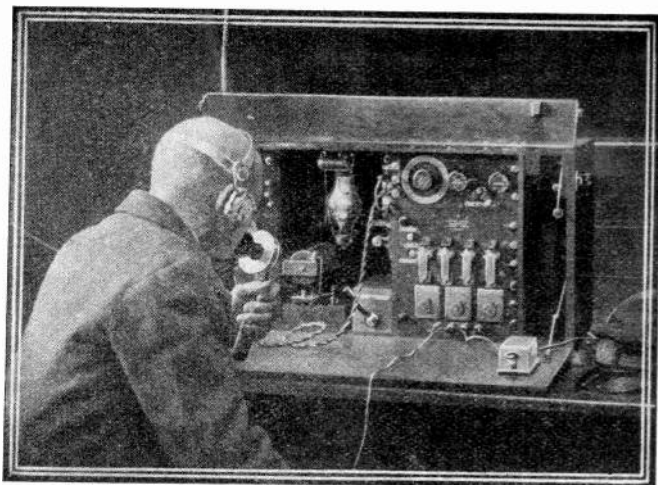

The First Commercial Wireless Telephone Service in Great Britain

is used for

Communications between the offices of the Mersey Docks & Harbour Board in Liverpool and the Bar Lightship beyond the mouth of the Mersey. The Marconi apparatus in each case is operated by the ordinary Harbour Board staff and has been in continual use since its installation over a year ago. — "Calling up" is performed by means of the
 ☉ ☉ *Marconi wireless bell* ☉ ☉

MARCONI'S WIRELESS TELEGRAPH CO., LTD.
 MARCONI HOUSE, STRAND, LONDON, W.C.2
 Telephone: CITY 8710.

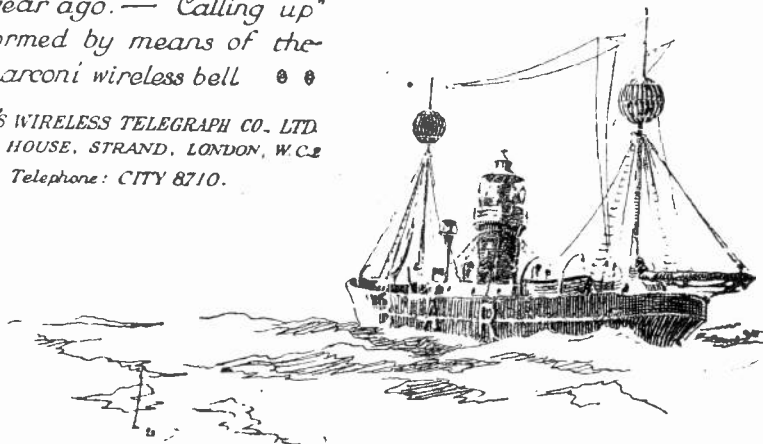

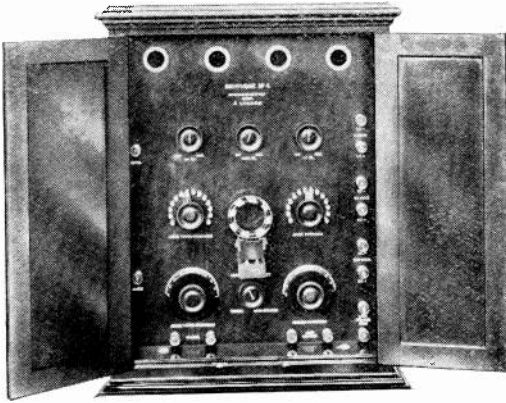

“BRITPHONE” No. 4

Cabinet Measurements, $20\frac{1}{2}'' \times 16\frac{1}{2}'' \times 9\frac{1}{2}''$. Range covers 200-25,000 metres wavelength.

An excellent Four-valve Broadcast Receiver in polished mahogany cabinet, with folding panelled doors fully in keeping with the general appearance of the instrument. The receiving panel is of Radion Mahoganite.

The Receiver includes 1 H.F., 1 Rect., and 2 L.F. Steps. The last valve by means of a switch acts as either an ordinary magnifier or a power valve for use with any loud speaker. The high tension voltage on this valve can be anything up to 400 volts, thereby obtaining tremendous increase in volume of sound; this is extremely suitable for entertainments in large halls or out in the open. Price complete with all accessories, including four valves and coils up to 4,000 metres, **Forty Guineas.**

A Loud Speaker can be chosen from the large selection we have in stock. Prices from **£2 7s. 6d.**

All “Britphone” Apparatus is approved by the Postmaster-General, and is manufactured under Marconi Patents.

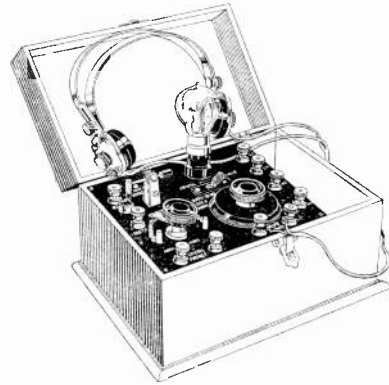

“BRITPHONE” No. 2

The “Britphone” No. 2 can be used simply as a Crystal Receiver, or as a combination of crystal and valve. The addition of the valve is obtained by a special switching device. This set gives extremely clear reception of music, speech and Morse code.

It is contained in solid mahogany case of excellent workmanship and finish. Eminently suitable for Broadcast concerts.

The price includes coils up to 2,000 metres, aerial wire, insulators, headphones, valve accumulators (4 volt 60 amp.), H.T. Battery (60 volts), and also all royalties of the British Broadcast Company.

Price £13 10s.

By the addition of other “plug-in” coils the range can be increased up to 25,000 metres.

BRITWIRE MARK IV.

Valves. Panels of Radio Mahoganite.

Receiver manufactured under Marconi patents and for use under an experimental licence. One H.F., one rectifying, and two L.F. Further details on request.

PRICE: RECEIVER, £21.

TUNER, £8 10s.

Newark, New Jersey, U.S.A., Telephony has been received clearly and distinctly on our Mark IV Receiver, in Bolton, Lancs.

BRITISH WIRELESS SUPPLY Co., Ltd.

HEAD OFFICE: 6, Blenheim Terrace, LEEDS. Telephone: 26926.

LONDON SHOWROOMS. Our new Showrooms are well situated, excellently appointed and carry a full stock of all “BRITWIRE” manufactures. *Demonstrations Daily.* 64, FRITH ST. (Off Shaftesbury Avenue, W.)

18, Eldon Square, Newcastle.
Telephone—Newcastle-on-Tyne 360 City.

11, Church Street, West Hartlepool.
Telephone—West Hartlepool 373.

33, High Street, Southampton.
Telephone—Southampton 403.

8, Corporation Street, Belfast.

"M.V." (Belgium).—The circuit given on page 883, September 30th issue, and the coil system to which you refer, will be quite suitable for the reception of short wave telephony. L.F. transformers usually have a ratio of 1 to 2 or 1 to 3, and it is better to use a small ratio and have a large primary impedance, than to have a large ratio transformer with a low primary impedance. The telephone transformer should have a high impedance primary, and the secondary should be wound to match the impedance of the telephone receivers. When using low resistance telephones, the secondary has a low impedance. Pin type H.F. transformers are quite suitable in a circuit of this kind, and the primary winding could be tuned with a variable condenser of 0.0002 mfd. maximum value. A 0.0005 mfd. variable condenser is useful for tuning the reaction coil, and while it may not always be required, probably you will find it useful on occasions. The H.F. transformers in your possession will probably tune to 1,000 metres, and while they are quite useful, you will get better results when using the plug-in type H.F. transformer. We understand from your figure that the aerial is 26 feet high. The aerial could, with advantage, be raised another 30 feet. We suggest you construct the H.F. transformer, particulars of which are given in the articles on "Experimental Station Design," which appeared in the issues of September 2nd and 16th.

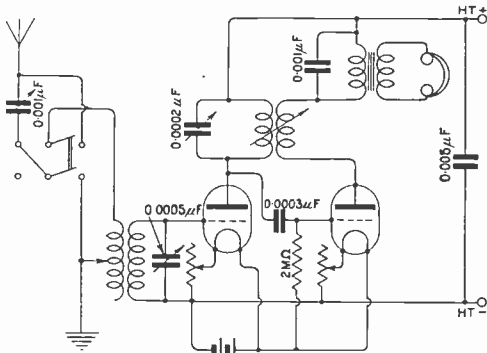

Fig. 5.

"J.E.H." (Herts) asks for a three-valve circuit using an H.F. transformer.

(1) See Fig. 5. The primary and secondary windings could consist of a number of basket coils connected in series. The coils should be spaced with $\frac{1}{4}$ " insulating distance pieces, and tapings taken to switches. The anode and reaction coils could also consist of basket coils. The values of condensers, etc., are marked in. A switch is provided for joining the A.T.C. in series or parallel with the A.T.I. The A.T.C. and A.T.I. should be in series when receiving short wavelengths.

"R.R." (Paris).—The Armstrong super-regenerative circuit is described in the issues of October 21st and 28th, and your difficulties will probably disappear when you have read the second and concluding portion of the article. A suitable variometer would have as its rotor a ball 5" diameter, and the stator would be correspondingly larger. A two-pile winding has just less than four

times the inductance of a single layer winding of the same mean diameter and length.

To cover a wavelength of 150 to 25,000 metres, using a tuning condenser of 0.0005 mfd., would require a coil with a maximum inductance of 360 millihenries. If you could use a larger condenser, say 0.0015 mfd., the coil would need an inductance of only 120 millihenries, which is a much more reasonable proposition. We suggest a five-pile winding, and a coil 5" diameter and 6" long, using No. 24 D.S.C. wire. You will need at least 15 tapings.

"W.B." (Wellington).—The circuit given on page 474, October 29th, 1921, is quite suitable, and very good results are obtainable. The oscillation transformer has two secondaries, and the potentials are applied to valves connected one in each side of the Wheatstone bridge.

"W.H.S." (Wimbledon).—We do not recommend the use of plugs and jacks in H.F. circuits, but the circuit arrangement submitted, making use of plugs and jacks, is correct apart from the connections marked in. The proposed arrangement shows the reaction coil coupled with the aerial coil. Unless very great care is used, energy will be transferred to the aerial circuit. We prefer to couple the reaction coil to a secondary circuit, or better still, to the H.F. transformer connected between the anode of the first valve and grid of the second. The H.F. transformers are suitable, but you may find it better to tune each primary winding with a small condenser consisting of two moving and three fixed plates. We consider the primary winding of the L.F. transformers has too few turns, and we think you should use at least 6,000 turns in the primary. The grid condenser should be 0.0003 mfd. Condensers F1, 2 and 3, across the L.F. transformers, should have a capacity of 0.001 mfd. The valves and telephones suggested are quite suitable.

"K.K.P." (Cambridge).—The proposed arrangement is not very suitable, because the presence of an inductance coil in series with the loop limits the size of the loop, and therefore the amount of energy picked up. A better arrangement would be to use a larger loop, and tune the loop with a small variable condenser. A condenser with a maximum capacity of 0.0003 mfd. is suitable provided tapings are taken from the loop. We suggest you use a frame 5' square, with 10 turns of wire spaced $\frac{1}{4}$ " apart, and take 5 tapings.

"CHAKOO" (Brentford) asks wavelength of loose-coupled tuner.

The tuning wavelength range of your coils when connected to the aerial will be from about 150 metres to 800 metres.

"S.M." (Bristol) asks several questions concerning a "Broadcast Receiver" by Bull, described in the issues of August 26th and September 2nd.

(1) Provided you employ suitable inductions, you should be able to tune up to 25,000 metres. (2) You will find the plug-in type of transformer quite suitable. (3) "R" type valves are quite suitable for use in this amplifier. (4) The A.T.C. may have a maximum value of 0.00015 mfd., and the closed circuit tuning condenser 0.0005 mfd.

"L.B." (S.E.3) asks (1) *The correct value of grid leak.* (2) *Why best results are obtained when the filament resistance is short-circuited.* (3) *Whether PCGG should be received using a single valve set.* (4) *Any suggestions for the improvement of his set, particulars of which are submitted.*

(1) You will find 2 megohms a suitable value of leak resistance. (2) Probably the use of a 4-volt filament battery is the reason. We suggest you use 6 volts with the resistance. (3) We do not think so. (4) We suggest you increase the anode potential to 60 volts, otherwise the set is correct.

"ULTRA V" (Durham) asks (1) *For a circuit utilising components in his possession.* (2) *From what distance he should receive signals using a loop aerial.* (3) *Dimensions of a loop aerial.* (4) *The correct H.T. volts.*

(1) See diagrams given in recent issues. (2) Without detailed knowledge of your set we cannot say. (3) We suggest a frame 4' square wound with 15 turns of No. 18 D.C.C. The turns should be spaced a little and four tappings be taken. (4) With "R" type valve about 60 volts.

"M.G.K." (Greenock).—The figure to which you refer shows the method of connecting a tuned anode H.F. valve with a detector valve. The tuned anode winding may be a coil of No. 30 S.S.C. wound on a former $2\frac{1}{2}$ " diameter and 6" long with 16 tappings. This circuit should be tuned to the wavelength of the signals received. When the two valves are connected to form a 1 detector and 1 L.F. combination, there are less adjustments to be made, but signals will not be so loud as with the H.F. and detector connected valves. The advantage of using a telephone transformer and low resistance telephones over the use of high resistance telephones connected directly in the anode circuit lies not so much in any difference in signal strength, but in the robustness of the former arrangement. The high resistance telephone windings are of very fine wire, and the insulation is easily destroyed.

"E.N." (Kent) has difficulty in getting an iron choke, inductance about 1 henry, made up and asks for particulars.

We think any firm of electrical engineers would gladly undertake to make this choke for you. The choke is quite simply constructed. It may consist of a bundle of iron wire with a diameter of $\frac{1}{4}$ ", upon which is wound 2,000 turns of No. 36 S.S.C. wire. If you have a small intervalve transformer, you could connect the two windings in series and use that, or if you have an old intervalve transformer which is damaged, you could rewind it with the No. 36 S.S.C. wire. The value of this choke is not critical.

"H.W." (N.1).—The diagram on page 883 September 30th issue, indicates the method of connecting up 5 valves with switches to cut in or out valves as required. Double pole throw over or the Dewar type of switch is suitable. The H.F. transformers will, we assume, be already mounted as indicated in the sketch submitted. It is then only necessary to join them in circuit as indicated by your sketch.

"L.F. ICI" (Kilmarnock) asks (1) and (2) *where he can obtain particulars of the construction of a Marconi receiver.* (3) *Where to obtain particulars of the construction of a 3-valve set.*

(1) and (2). We have no particulars of the construction of this type of receiver, and we suggest

you build a tuner yourself. The A.T.C. should have a maximum value of about 0.001 mfd. The A.T.I. could be a coil 4" diameter and 8" long wound full of No. 24 D.C.C. wire with 18 tappings. The secondary coil could be a winding of No. 28 D.C.C., $3\frac{1}{2}$ " diameter and 9" long, with 12 tappings, and is tuned with a condenser of 0.0005 mfd. maximum capacity. (3) The construction of a 4-valve set is described in the issues of July 15th and 22nd, and November 25th, and you will be able to easily modify the receiver so that 3 valves are used.

"AERIAL" (Chiswick) asks (1) *For a diagram for crystal set.* (2) *How far it will receive speech.* (3) *The crystal to use.*

(1) See Fig. 6. The A.T.I. could consist of a coil 5" diameter and 6" long, wound full of No. 22 D.C.C., with 12 tappings. (2) With careful adjustments the range will probably be 15 miles from a broadcast station. (3) We suggest you use a perikon detector.

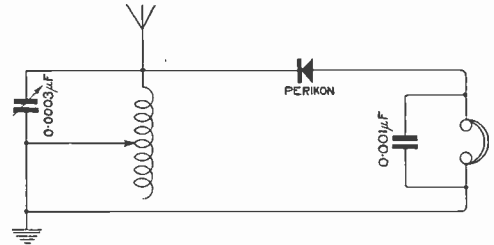

Fig. 6.

"J.S." (E.C.1).—The frame aerial may consist of a frame 4' square, upon which is wound 15 turns of No. 18 D.C.C. wire, spaced $\frac{1}{4}$ " apart. Five tappings should be taken to the switch for rough tuning. We consider the units in your possession sufficient to operate a loud speaker satisfactorily. The term microfarad means one-millionth of a farad. The farad is the unit of capacity, and a condenser has a capacity of one farad when it is charged to a potential of one volt by one ampere. The call "CQ" means all stations. When a station is transmitting and the call "CQ" is made, all stations are invited to listen in.

SHARE MARKET REPORT

Prices as we go to press on December 15th, are:—

Marconi Ordinary	£2 2 9
.. Preference	1 19 6
.. Debentures	101 15 0
.. Inter. Marine	1 6 0
.. Canadian	9 4½

Radio Corporation of America:—

Ordinary	15 9
Preference	13 6

The World listens in on MULLARD PHONES

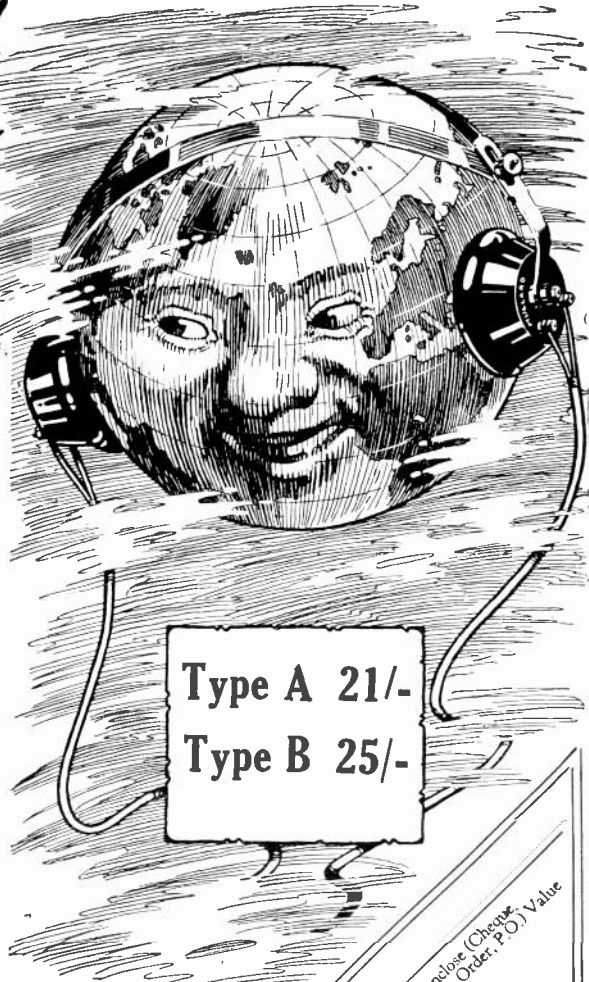

Specially made for the reception of wireless broadcasting, Mullard 'phones' are thoroughly well made and fit comfortably to the head, &c.

British Manufacture.

The two high resistance ear pieces (4,000 ohms total) are flexibly attached to the fully adjustable, double head bands. The set is nicely finished in nickel-plate and supplied complete with standard flexible cords.

Send the coupon to-day to secure immediate delivery.

These telephones are made by the makers of the famous "ORA" valve and Mullard valve accessories.

Type A 21/-
Type B 25/-

MULLARD "ORA" VALVES

We hope to get a greatly increased output of these famous valves at our large new factory.

Meanwhile - - ORDER AT ONCE.

Mullard Radio Valve Co., Ltd

45, Nightingale Lane, Balham, S.W.12.

Contractors to H.M. Admiralty,
War Office, Royal Air Force &
Post Office.

Telephone: Codes: Telegrams:
Battersea ABC (5th Ed.) "Radiovalve,
1046. Bentley's Wandsworth, Lond."



Name and Address.....
To the
MULLARD RADIO
Valve Co., Ltd,
45, Nightingale Lane,
Balham,
S.W.12.

Please send me post free:

Quantity	Description	Price
.....	Telephone Head Sets	Type A 21/-
.....	"ORA" Valves	Type B 25/-
.....	Grid A Resistances	15/- each
.....	Anode A or B Resistances	2/6
.....	B A Condensers 0003 mild	7/6
.....	Combined Resistance	5/-
.....	Valve Bases with Condenser	1/3
.....	Valve Sockets	9d. per pair
.....	Terminal Clips	
.....	Name of usual Wireless dealer:	

I enclose (Cheque/Money Order, P.O.) Value
to cover the
cost.

**SEND THIS
TODAY.**

LESLIE M^c MICHAEL LTD.

BROADCAST RECEIVING SETS

The following are a few of the many Receiving Sets which we manufacture for the use of those holding either Broadcast or Experimental licences:—

RADIOMAC CRYSTAL, MARK III. The range of this set is about 50 miles, wavelength 50-700 metres; covering the entire broadcasting and range used by shipping. Brand new in mahogany box complete, with pair of 4,000 ohm telephones.
Price, including Broadcast Fee. **£10 10s.**

RADIOMAC 2B. A two-valve set in polished mahogany box, range covers all broadcasting. The set has provision made for "plug-in" coils, in order to cover all wavelengths.
Price of set **£9 9s.**

Accessories to make complete receiving station, **£5 2s.**
Licence Fee payable through us to the British Broadcasting Co. **£1 15s.**
Total cost of complete station **£16 6s.**
Carriage paid.

RADIOMAC 3B. A three-valve set of greater efficiency. Price **£12 12s.**
Accessories suitable for same **£5 19s. 6d.**
Licence Fee payable through us to the British Broadcasting Co. **£2 5s.**
Total cost of complete station **£20 16s. 6d.**
Carriage paid.

All our valve apparatus is manufactured under Marconi Licence.

We guarantee all the above sets which were originally purchased by H.M. Government. They are new and in perfect condition.

London Showrooms: 179, STRAND (Corner of Norfolk Street), W.C.2

Head Office, to which all correspondence should be sent:

HASTINGS HOUSE, NORFOLK STREET, STRAND, LONDON, W.C.2

OUR LONDON SHOWROOMS

are now open, and in order to enable us to stock goods of our own manufacture only, we are offering the remainder of our ex-Government stock at the following ridiculously low prices:

MARK 3 TUNER, brand new (excellent for broadcasting reception) - **£7-0-0**

B. MARK 2 RECEIVERS, two valve, with aerial tuning condenser. Sold elsewhere at from £4 15s. od. to £7 5s. od. - - - - **£3-5-0**

BRITISH WIRELESS SUPPLY CO., LTD.

64, FRITH STREET, SHAFTESBURY AVENUE, LONDON, W.

See our further full page advertisement on page xxii.

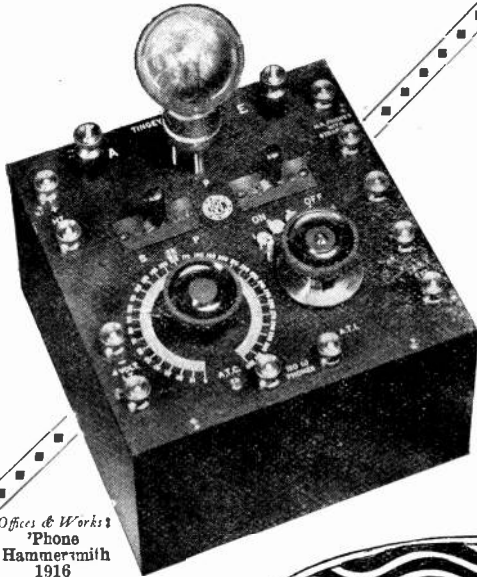

Offices & Works
'Phone
Hammer-smith
1916

Telegs.
"Tingydar. London."

You may depend upon it

that if the name TINGEY is on a wireless instrument, it is perfectly efficient in every detail. Here is a selection from the splendid TINGEY range.

SINGLE VALVE BROADCAST RECEIVING SET.

Wave length 300-2,800 metres. Complete with all accessories, including valve, Brown's phones, high tension battery, accumulator, 100ft. aerial wire, insulators, lead-in tube and earthwire.

ALL TINGEY instruments bear the B.B.C. stamp.

PRICE - 14gns.

including Broadcasting Fees. Carriage paid U.K.

Send for our beautifully illustrated Catalogue, containing full details of our 2, 3, and 5 valve sets to—

Offices & Showrooms :
92, QUEEN ST.,
HAMMERSMITH
LONDON, W.6.

TINGEY WIRELESS LTD.

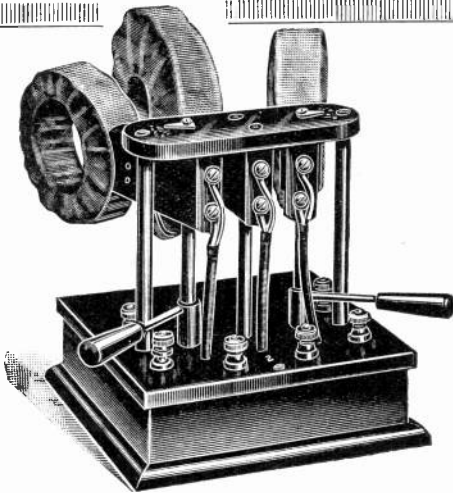

Orders to the value of more than 20/- post free. Lists free.

COIL HOLDER

in best finish for 3 coils, 25/-
Set of 4 Broadcast Coils for above 25/-

EVERYTHING FOR WIRELESS

H. V. ALBROW, WIRELESS ENGINEER

56, George St., Baker St., London, W.1
2 Mins. from Selfridge's. 'Phone Mayfair 5842

BUTLER'S RELIABLE MANUFACTURES

Before buying elsewhere
SEND FOR OUR FULLY
ILLUSTRATED LIST

Post free 4d.

H. D. BUTLER & CO., Ltd.

Offices :

222, Great Dover Street, London, S.E.1.

Showrooms and Works :

61, Borough Road, London, S.E.1.

Telephone · HOP 3029.

"The Services use them"

BACK in 1909 the Admiralty adopted Ericsson Telephones *as standard*. In 1917 the R.A.F. followed the Senior Service's example. Protracted tests proved Ericsson Phones' immense superiority over long distances. Clarity of speech and total absence of distortion in telephony placed them in a class by themselves. Telegraphists tell us they get distinct signals when other makes indicate "nothing doing." Light and easy to the head, robust in construction yet delicate in operation, they put the ideal finishing touch on any set-crystal or valve.

Write for fully illustrated descriptive List free.
The BRITISH L. M. ERICSSON MANUFACTURING Co. Ltd.
International Buildings, 67/73, Kingsway, W.C.2

2,000 ohms, pair - **31/-**
4,000 ohms, pair - **32/-**
(All Resistances in Stock)

Ericsson
Telephones

1923

THERE is every indication that 1923 will see an unprecedented demand for wireless goods and service. Competition will be keener than ever, and progressive firms are leaving nothing to chance in their preparations to secure a full share of the coming trade.

THE ultimate success of many wireless businesses will depend upon the advantage taken of opportunities during the next twelve months. The right goods, the right kind of advertising and efficient organization will be the determining factors.

IF your plans for 1923 are still incomplete, if you have any problems or difficulties, I invite you to discuss the matter with me. The accumulated knowledge of ten years' unique experience in wireless advertising and business building is at your disposal—to help you to make the best of your chances for 1923.

I am open to deal with one or two sound provincial accounts.

Bertram Day

BERTRAM DAY & CO., LTD.,

*Wireless Advertising Specialists
Contractors, Printers & Publishers*

B
|
D

*Organisers of the First All-
British Wireless Exhibition, 1922*

9 and 10, CHARING CROSS, S.W.1

BRANCHES AT MANCHESTER & GLASGOW

GERRARD - 8063, 8064 and 8065
" ADBERTRADA, WESTRAND, LONDON "

VARIOMETERS

American Pattern in Selected Beech, wound complete as illustration.

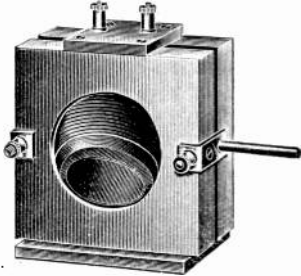

PRICE
18/6

Subject to Trade Discount. Standard winding 600 metres, but can be wound for 200 metres or 1300.

Another pattern in Ebonite, price 12/9, wound, but without knob and dial; knob and dial 1/9 extra.

Accumulators

HIGHEST QUALITY. LOWEST PRICES.

In Celluloid Cases.

4 Volt 40 Amp. ..	18/6	6 Volt 40 Amp. ..	26/3
4 " 80 " ..	21/6	6 " 80 " ..	32/9
4 " 80 " ..	28/2	6 " 80 " ..	37/8
4 " 100 " ..	30/-	6 " 100 " ..	43/6

SPECIAL LINES.

6 Volt 40 ACTUAL amp. in 3 glass cells, sealed tops, and in well-made Teak Crates, 49/8 each.

4 volt 24 amp. in celluloid cases at 11/9 each.

Packing Free. Carriage Forward.

All Subject to TRADE Discount.

Write for Lists.

F. YATES & SON, LTD.,

WHOLESALE ELECTRICIANS,

144, Church St., Kensington, London, W. 8

'Phone: PARK 4276.

One minute from Notting Hill Gate Station.

ELECTRADIX RADIOS

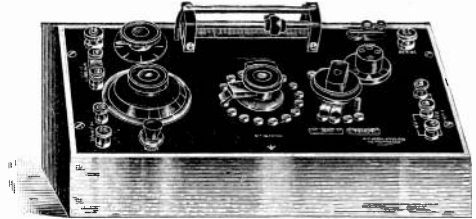

RECEIVING SETS. 50 D.C. Trench, sloping panel, crystal and valve. Ex Marconi; as illustrated, with H.R. 'phones, - - - **£7 15s.**

TWO-VALVE MK. II, with three-coil holder, variable condenser, complete with 'phones, less valves and batteries - - - **£8 0 0**

Both sets tested on our aerial and ready for use. Three-valve Amplifiers, **£5 10s.** Battery boxes, 4/-, 5/- and 7/-.



LARGE PURCHASE OF TELEPHONES NOW OFFERED AT REDUCED PRICES. Single L.R. Receivers, 4/- Head Sets L.R., with double head-band and cord, 8/6. Sullivan sets, ditto, with plug and jack, 14/-, 1,500 ohm headsets and cords, 17/6. 2,000 ohm, 19/6. Marconi Sterling, from 49/-. Sullivan single receivers for rewinding, 2/6 each. 'Phone transformers, 14/- each.

THIS WEEK'S BARGAIN. Broadcast Aerial Outfit. 100' 7 22 copper aerial, 8 R.A.F. insulators, lightning arrester on ebonite base, P.O. type. Downlead, 35/40's rubber-covered 12 yards aerial to set, 10/- post free.

VARIABLE CONDENSERS. .002 Table moulded ebonite case, very fine, 38/-. Murdochs in all sizes, table and panel.

EBONITE, 1 1/16" sheet, 2 1/2 square, 2/6 each.

POLE FINDERS, 6d. each.

WESTON RELAYS. For recorders and micro-amplifiers, 40/- each, new.

H.T. DYNAMOS, 500 volts, **£16.** Six volts, **£4 10s.** Send us your enquiries as we have a huge stock of instruments of various types and all wireless sundries.

Call at our Showrooms in the City. We are near Aldgate Station, Metropolitan Railway, and 'buses pass the door. First Avenue on the left in Minories.

LESLIE DIXON & CO.

9 Colonial Avenue, Minories, E. 1.

F. WIGGINS & SONS

MICA

Telephone 1
Avenue 2248
Largest Stock
in the World.

FOR CONDENSERS AND ALL PURPOSES.

102, 103 & 104, Minories, London, E. 1

L.O. HERE IT IS.—M. E. C.



Crystal Receiver complete with everything in polished Cabinet. Royalty paid to B.B.C. Reg. No. 138. Carriage paid from stock. All tested and guaranteed they speak loud and clear.

Price
£3 : 15 : 0
complete.

M.E.C., Crownhill Road, Harlesden, London, N.W.10.
Wilkesden 3370

**CHAS. BAKER
AND CO.'S STORES, LTD**
LARGEST OUTFITTERS IN LONDON

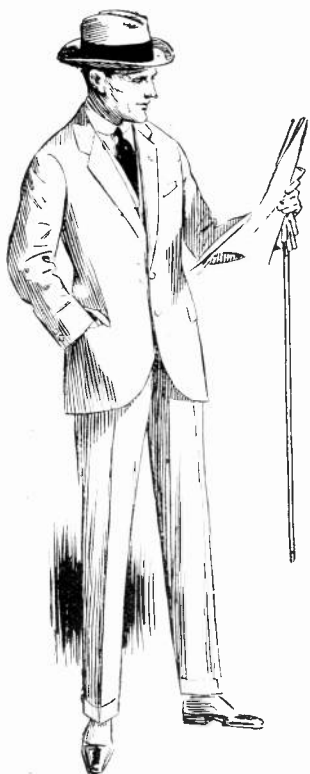

High-class Tailoring

AT MODERATE PRICES

INDIAN COLONIAL &
FOREIGN OUTFITS

Regulation Uniforms

Head Depot 271-274 HIGH HOLBORN
City Branch 41, 43 LUDGATE HILL
37-140 Tottenham Court Rd., 256 Edgware Rd., &c.

A BARGAIN
£85

Cannot replace under £285

**Electric Lighting
& Power Plants**
for **Country Houses
Workshops, Cinemas**

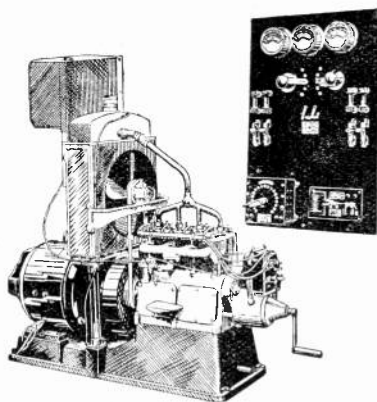

AUSTIN and STANDARD 3½ K.W. and 4¾ K.W., 110 volt, direct coupled LIGHTING AND POWER PLANTS, complete with ordinary switchboard £85 f.o.r. Special battery charging switchboard as above, £15 extra. Every set guaranteed. Suitable for either 110 volt or 50 volt country house lighting, garage, workshop or cinema plants.

DOUGLAS 2 cylinder, 3½ K.W. plants in stock, all prices. Large quantities of spare parts for all above sets always in stock at low prices. Complete workshops, Drummond and Colchester 5½ in. lathes, Luke and Spencer grinders, Wolfe electric drills, wall drills, etc., together with 110 volt meters.

C. H. & L. O. SMITH,
75, Canal St., Nottingham



Series No. 5

Makers of over Half
the World's Telephones.



Western Electric

LOUD SPEAKING EQUIPMENT.

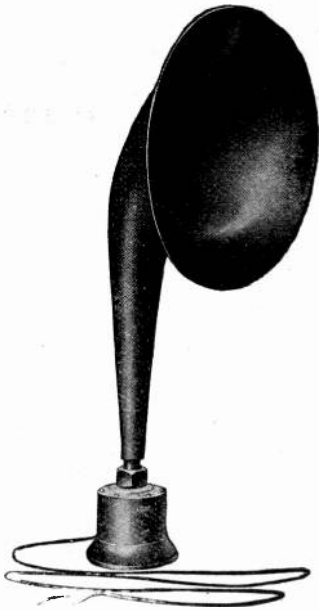

Clear and true production over the entire musical range is provided by this equipment which consists of a specially designed Loud Speaking Amplifier and a Loud Speaking Receiver. For general efficiency and absolute reliability there is no other equipment produced that can compete with it.

Makers of
over Half
the World's
Telephones

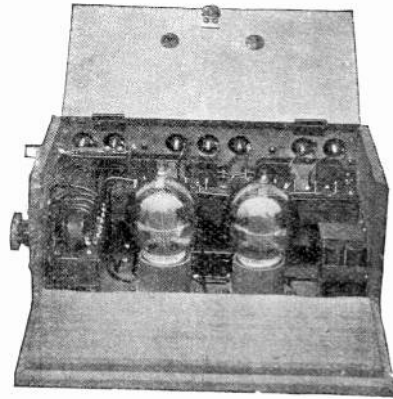

The Loud Speaking Equipment is used in conjunction with any good type of Valve Detector Set for amplifying radio telephone speech or music.

Western Electric Company Limited.

Connaught House, Aldwych, W.C.2

Telephone—London Wall 7608

WORKS:—

North Woolwich, London, E.16

Telephone—East 3840 (10 lines)

Also at BEXLEYHEATH, KENT, and NEW SOUTHGATE, N.11

Birmingham—Grenville Buildings, 12, Cherry St.

Leeds—Standard Buildings, City Square.

Cardiff—Motor House Chambers, 1, Wood St.

Manchester—Northern Assurance Buildings.

Newcastle—20 Saville Row.

Glasgow—49, West Campbell Street.



W. J. HENDERSON

**351, FULHAM ROAD,
SOUTH KENSINGTON.**

(Bus Routes Nos. 14 and 96 pass the door.)
(Nearest Stations, Earl's Court and South Kensington.)

ACCESSORIES OF QUALITY

Aerial Wire, 7/22 enamelled copper, per 100'	5/-
Aerial Insulators, brown porcelain	each 9d.
Aerial Stay Wire, 15 cwt. breaking strain, steel flexible cable (sample on request), per 100'	5/-
Aerial Mast Strainers (turnbuckles)	each 8d., per doz. 7/6
Coilholders, for three coils, for panel mounting, complete with terminals	each 14/6
Coilholders, Igranic, table stand, complete with extension handles and patent spring terminals	each 21/-
Coils, Igranic, duolateral	from 5/-
Condensers, fixed, .0003 and .0005	each 1/6
Condensers, fixed, Dubilier	each 2/6 and 3/-
Condensers, Variable, for panel mounting, complete with knob and pointer, Vernier, 5/-; .0003, 12/-; .0006, 15/-; .001, 20/-	
Ducon special "electric-light aerial" attachment, each	10/-
Filament Rheostats, for panel mounting, one valve	3/6
Three-valve	4/6
Grid Leak and Condenser, Dubilier	5/-
High Tension Batteries, 15-volt blocks, with flexible leads, long life	each 3/-
Insulated Sleeving, Red, Green, Brown, Yellow, per yard	5d.
Ivory Scales, semi-circular, engraved 0-180, best quality	each 1/-
Loud Speakers, Amplion, 120 ohms, £8; 4,000 ohms, £8	5s.
Potentiometers, circular type for panel mounting, complete with knob and pointer, 350 ohms	each 12/6
Reactances Coils (Radio Instruments), short wave, 20/-; all waves	25/-
Transformers (Radio Instruments), Intervolve	25/-
Telephone	20/-
Transformers (Igranic), Intervolve	22/6
Transformers, High Frequency, to fit valve holders—	
300m.	5/-
400m.	5/6
600m.	6/-
1,000m.	6/6
etc., etc.	
Telephones, double headgear, 4,000 ohms, complete with cords, extremely sensitive, per pair	22/6
Valveholders, mounted in ebonite, fitted with washers and nuts	each 1/-
Valves, M.O. "R" Type	each 17/6
Valves, Ora	each 15/-

The above are only a few selected items from our large stocks.

Terms, Cash with order; goods above £2 in value carriage paid.

Post Orders are despatched on day of receipt.

Lists on request.

A BROADCAST RECEIVER OF DISTINCTION



Registered design No. 693330. Post Office Registration No. 1033

Price £10 12s. 6d.

All our apparatus will be marked with the B.B.C. This set can be worked by anyone not having had any previous experience or knowledge in Wireless.

The materials used in the construction of the instrument are of the highest quality and manufactured by experienced Wireless Engineers.

Also supplied as complete receiving station including the following accessories:—1 pair Brown's Headphones, 4000 ohms, 1 Valve Marconi or Marconi Ediswan type "R," 1 4-volt 40-amp. Clifton Accumulator, 1 50 Siemens High tension Battery, 1 Lead-in Tube, 100 feet Aerial Wire (enamelled), 6 Insulators, 1 Earthing Clip.

Price inclusive **£16 10s. 0d.** Carriage paid United Kingdom

DO NOT FORGET that we are the agents for Messrs. Dubilier Condenser Co.'s specialities—delivery ex stock Manchester.



The Manchester Radio Co., Ltd.

RADIO ENGINEERS,

F. H. McCREA, Managing Director,
W. R. BURNE, Directing Experimental Department.

155, OXFORD RD., MANCHESTER

(Entrance Boundary Street East)

Telephone: Central 4935

CONDENSERS

DELIVERY FROM STOCK

High in Quality.

Low in Price.

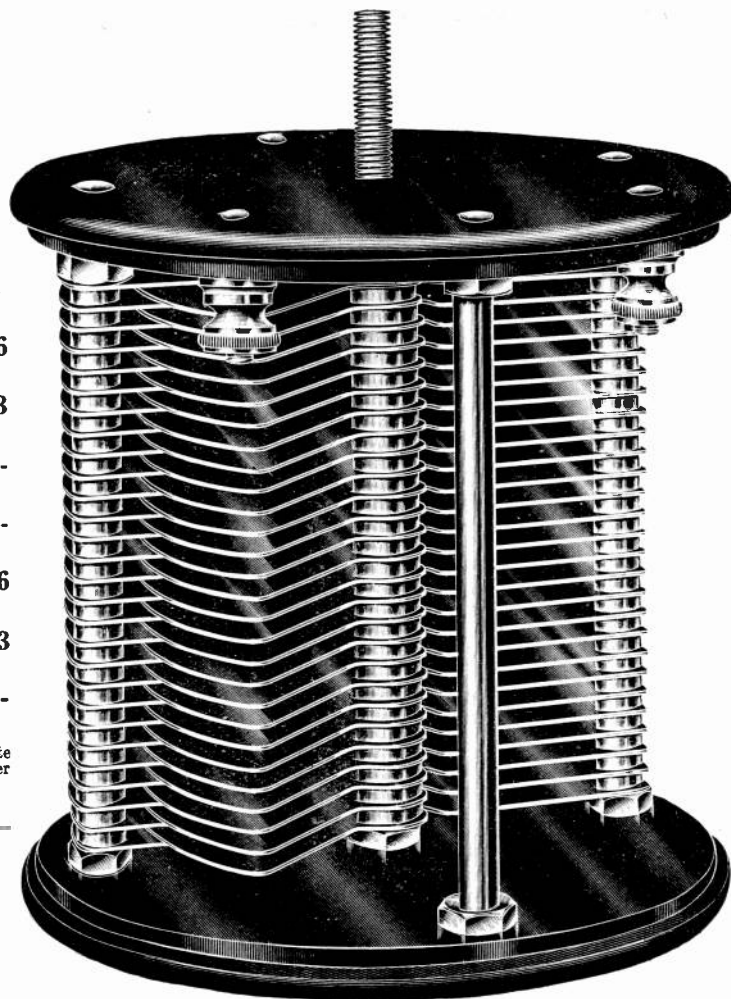

Un-
assembled

- 001 .. 6/6
- 00075 5/3
- 0005 .. 4/-
- 0003 .. 3/-
- 0002 .. 2/6
- 0001 .. 2/3
- 00005 2/-

Turned Ebonite
Plates 1/8 per
pair extra.



Assembled

- 001 10/6
- 00075 7/6
- 0005 .. 7/-
- 0003 .. 6/6
- 0002 .. 6/-
- 0001 .. 5/6
- 00005 4/6

Complete



ORMOND ENGINEERING CO.

199, Pentonville Road, King's Cross, N.1.

Telegrams : Ormondengi.

Telephone : Holborn 1812.

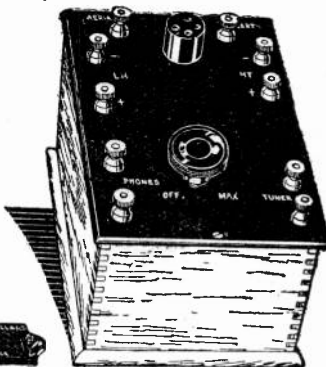
C.A.Co.**An Ideal Xmas Gift—Order Now****The Best Value in Single Valve Panel Sets on the market****No Finer Set could be built if 20 times the price were paid****30/-****Complete**

Comprising — Handsome polished mahogany cabinet, panel of best quality ebonite, well finished and bevelled edges, valve holder, filament resistance, 2 Mullard's Condensers, .0003 and .0002 mtds. Mullard's Grid Leak, 10 Terminals, 10 engraved terminal tablets, coloured systotlex and copper wire, blue print with full instructions,

Hundreds of these sets have already been sold. As will be observed, **ONLY THE VERY BEST COMPONENTS ARE SUPPLIED.** This is the secret of the success and popularity of this panel.



A Good Pair of Phones makes an exceptional Xmas Gift that will be appreciated by the recipient.

BROWN "A" TYPE, Aluminium Diaphragms at much below makers' prices. (Cords 3/6 extra)

120 ohms (maker's price 58/-)	£2 2 6
120 ohms Complete with Telephone Transformer (Value 25/- in Iron Case)	2 15 0

SULLIVAN PHONES (with Brown's Aluminium Headbands).

120 ohms	12 6
120 ohms Complete with Telephone Transformer (Value 25/- in Iron Case)	1 10 0
8,000 ohms	1 16 6

All our goods are sent on approval, against cash, for seven days.

THE CITY ACCUMULATOR CO., 79 Mark Lane, London, E.C.3

'Phone: AVENUE 1316;

Wholesale and Retail Distributors for Messrs. BURNDIPT, Ltd. Same Trade Discount Allowed as by Manufacturers.

AGENTS—London: H. V. ALBROW, 55, George Street, Portman Square, W.1.
Glos.: BRISTOL WIRELESS CO., 52, Cotham Hill, Bristol.
Leicester: WALTER ROWE, LTD., 96, Granby Street, Leicester.

S. Wales: SOUTH WALES WIRELESS INSTALLATION Co., LTD., 18, West Bude Street, Cardiff.
N. Wales, Lancs., Ches. & I.O.M.: THE "ALL-BRITISH" WIRELESS MANUFACTURES Co., LTD., 18, Vauxhall Road, Liverpool.

When buying an Accumulator for Wireless Work you should insist on three important details—

- (I) It must be a "BLOCK" Type.
- (II) It must be in celluloid cases. Ebonite cases are very much cheaper, but it is advisable always to be able to inspect the interior, and level, etc.
- (III) It must be made up of separate 2-volt Units, the many advantages of which are apparent to all experimenters.

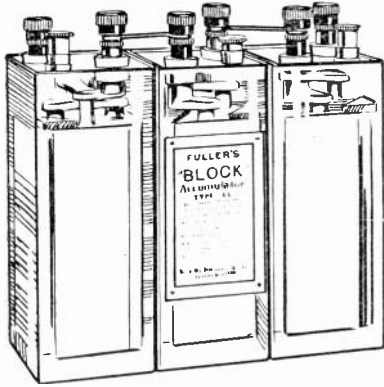

Type 640, £2 8 9

A SUMMARY OF THE PRINCIPAL ADVANTAGES OF BLOCK ACCUMULATORS

- (1) They are "fool-proof."
- (2) There are no plates to buckle.
- (3) It is impossible for the cells to be spoilt through accidental short-circuiting, and even if the terminals are joined by a metal bar, the cells will not be spoiled or seriously injured.
- (4) They will retain their charge for many months.
- (5) Sulphating cannot occur to any serious extent, as this is mostly caused through cells standing in a discharged state or being discharged through accidental short-circuits.
- (6) The blocks are so constructed that they cannot swell or grow and this prevents the external box or container being cracked or broken.
- (7) If the cells are neglected, or left in charge of inexperienced hands, no serious harm can be done, as even when discharged down to 1.5 volts, they recover their voltage and maintain their recovery, thereby preventing sulphate forming.
- (8) They are lighter and have a higher capacity per pound weight than ordinary plate accumulators, and can be re-charged an indefinite number of times.

WHY WE CAN SELL BELOW THE MAKERS' PRICES.

Some time ago we purchased an exceedingly large stock of "Block" Type Accumulators from the Government on terms which permitted our re-selling them at a much reduced price. During the last two years, we have disposed of several thousands in all parts of the world and most of the largest and best known electrical firms are numbered amongst our customers.

During this period, we have built up, on sound business lines, probably the largest Accumulator business in existence. We buy only on the largest scale and no opportunity escapes us so long as the quality of the stock is right. We have a perusal of the following prices and comparison with the cost of the identical article if bought in the ordinary way, will show the considerable saving which can be effected by dealing through us.

recently purchased outright a parcel of "Block" Accumulators direct from the manufacturers' works, to the value of several thousand pounds and being content with a small margin of profit on a large turnover, we are able to offer these world-famous cells for re-sale at a considerable saving to the customer.

It is our inevitable rule to share any bargains with our customers, and our system of business will be to put money into the pockets of those who deal with us. It is on these principles that our business has reached its present magnitude.

A perusal of the following prices and comparison with the cost of the identical article if bought in the ordinary way, will show the considerable saving which can be effected by dealing through us.

TYPE.	VOLTS.	Intermittent capacity at 20-hours rate.†	Maker's Price.	Our Price.	TYPE.	VOLTS.	Intermittent capacity at 20-hours rate.†	Maker's Price.	Our Price.
440	4	40	£ s. d.	£ s. d.	B L 480	4	160	£ s. d.	£ s. d.
640	6	40	2 15 0	1 12 8	B L 680	6	160	4 9 0	3 4 0
B L 440	4	80	4 2 6	2 8 9				6 13 6	4 16 0
B L 640	6	80	3 10 0	2 8 0	For those who require a cheaper Accumulator of the plate type, we can offer FULLER'S STANDARD PLATE TYPE BATTERIES as under.				
B L 455	4	110	5 5 0	3 12 0	S L 230	2	30	0 14 6	0 9 0
B L 655	6	110	4 1 0	2 15 0	S L 430	4	30	1 9 0	0 18 0
B J 4120	4	120	6 1 6	4 2 8	S L 630	6	30	2 3 6	1 7 0
B J 6120	6	120	4 8 0	2 18 0	S L 280	2	80	1 3 0	0 14 0
			6 12 0	4 4 0	S L 480	4	80	2 6 0	1 8 0
					S L 680	6	80	3 9 0	2 2 0

† Note:—The Ignition Capacity is double the Actual Capacity taken at the 20-hour rate.
Prices for Teak Carrying Crates or Cases on application.

The name "FULLER" is behind every one of these batteries, a certain guarantee of quality, for nothing but the best and purest materials are used in the manufacture of their products.

The CITY ACCUMULATOR CO.,

79, Mark Lane, E.C.3

AGENTS—London: A. V. ALBROW, 56, George Street, Portman Square, W.

Glos.: BRISTOL WIRELESS CO., 52, Cotham Hill, Bristol.

S. Wales: SOUTH WALES WIRELESS INSTALLATIONS CO., LTD., 18, West Bute Street, Cardiff.

Lancs.: ALL-BRITISH WIRELESS MANUFACTURERS CO., LTD., 18, Vauxhall Road, Liverpool.

Leicestershire: WALTER ROWE, LTD., 96, Granby Street, Leicester.

AVENUE 1316
9938
Phones— " " 91
" " 92
" " 93

WIRELESS BROADCASTING

3 Good receivers



Fellocryst

A simple and reliable crystal receiver for all wavelengths from 300 to 1500 metres. Complete with one pair 4000 ohms double headphones, 100 ft. aerial and insulators.

£ 3 : 7 : 6 (Postage 1/6 extra)

Fellocryst Super

For fine tuning for all broadcasting wavelengths from 300-500 metres. Mounted in oak cabinet and highly finished, complete with one pair 4000 ohms double headphones, 100 ft. aerial and insulators.

£4 : 7 : 6 (postage 2/- extra)

Fellophone

2 VALVE RECEIVING CABINET For all broadcasting wavelengths from 300-500 metres. In solid oak cabinet complete with H.T. battery, 6 volt accumulator, 4000 ohms double headphones, 100 ft. aerial and insulators, but without valves.

£9 : 0 : 0 (carriage 2/- extra)

2 Mullard "ORA" valves for Fellophone - - 30/- extra
Extra headphones complete, 21/- per pair.

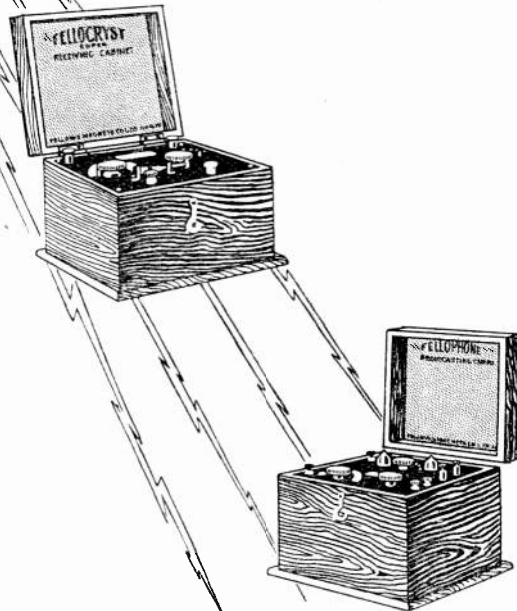

"for they are jolly good Fellows" 5.

FELLOWS MAGNETO CO., LTD.

Telephone :
Willesden 1560-1

LONDON, N.W.10

Telegrams :
Quixmag, Phone, London.



100,000 more people

—London's flat-dwelling population may now receive the broadcasting on an indoor aerial!

The IND-AERIAL HOOK supports the Aerial *one foot* from walls in its insulated arm.

To the Amateur.

THE IND-AERIAL HOOK opens up a new field of investigation to you. You can experiment with any form of indoor aerial with the greatest of ease.

To your friends and neighbours you can demonstrate the wonders of Radio in their homes by taking a few IND-AERIAL HOOKS and your portable set. With Valve Sets the indoor aerial can be connected as a loop, thereby rendering unnecessary the earth connection.

A 12' x 12' room allows an indoor aerial length of 45' to 50'. IND-AERIAL HOOKS can be attached to the picture rail of any room, hall, lobby, passage, office, nursery, etc., and taken down again in a second. No screws or nails required.

Supported on IND-AERIAL HOOKS, the wire does not interfere with curtains, pictures, ornaments, etc. Flexible insulated wire is recommended. Astonishing results have been obtained on indoor Aerials with valve and crystal sets.

The IND-AERIAL HOOK is handsome and substantial, made of nickel plated brass and ebonite, and is not even a temporary disfigurement to the most beautiful room.

IND-AERIAL COMPANY.
47 Victoria St., London S.W.1.
'Phone: VICTORIA 1705.

**IND-AERIAL
HOOK**
Prov. Patent.

PRICES:

2/9 Each.

Set of **10/6**

POST FREE

Send P.O. to-day
and secure yours

*With
IND-AERIAL HOOKS
the Radio Manu-
facturer, dealer, or
salesman can imme-
diately rig up an Aerial
on the spot and
demonstrate his
apparatus.*

Just what the Public want

A Radiophone Receiving Set which is so simple to operate that anybody without the slightest knowledge of wireless apparatus can use it instantly

**Switch on and rotate one knob
for clear and true reception**

**SIMPLE
NEAT
COMPACT**
Approved
by P.M.G.

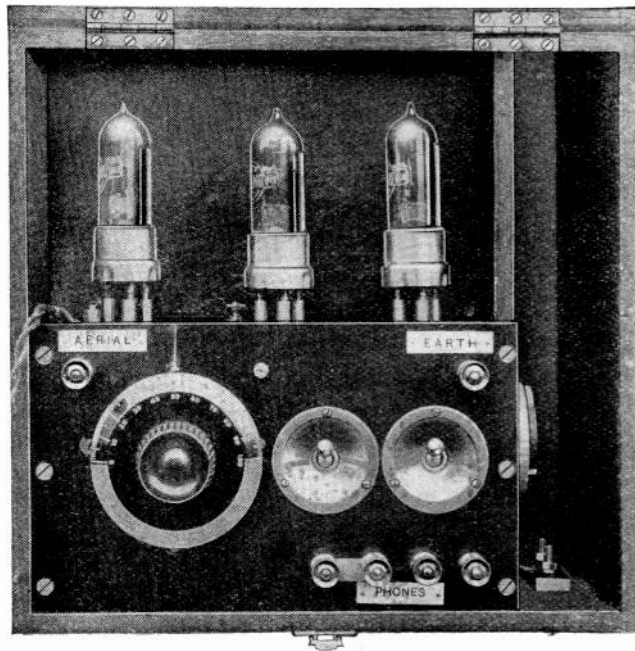

**WRITE
TO-DAY**
for
**Illustrated
Price List**

Trade Buyers write us for Terms for Re-sale

Made by

RADIOPHONES LTD.

1a GRANVILLE PLACE
MARBLE ARCH
LONDON, W.1

Phone :
Mayfair
1250.

Wires :
"Radpholim,
Baker, London."

"SIMPLICITY with SATISFACTION"

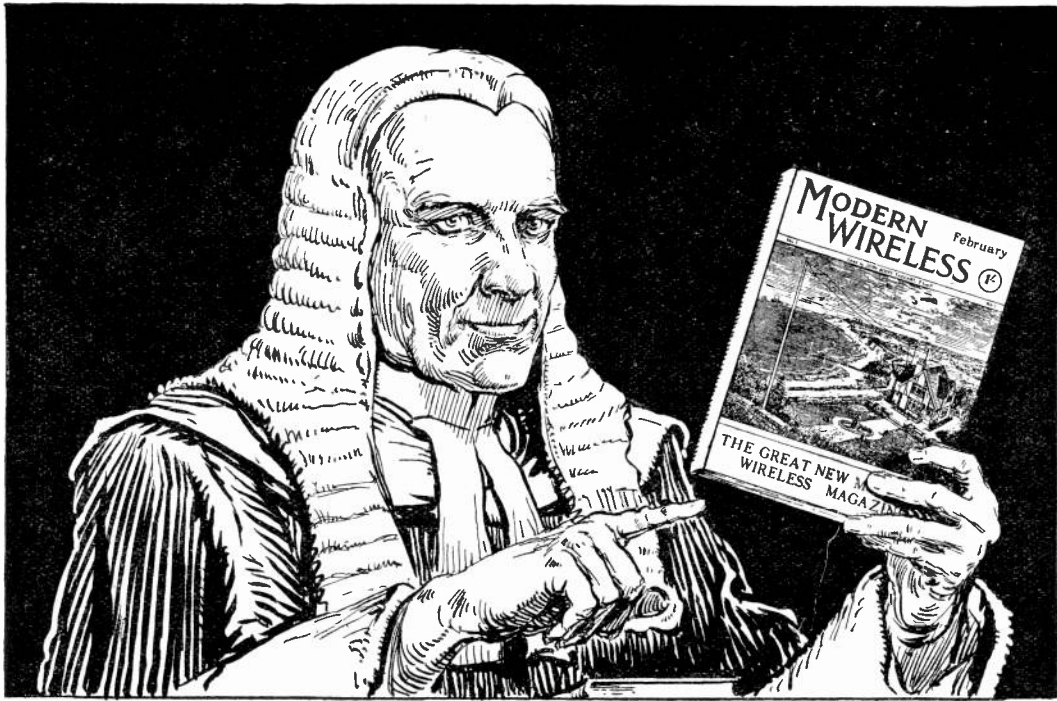

A good judge of a Wireless Periodical will remember

JANUARY 15th

On this day will be published "MODERN WIRELESS," the new monthly wireless magazine for all interested in wireless, but especially for the genuine experimenter and would-be experimenter.

It will cost 1/- net.

It will be something new in wireless literature.

It will specialise in the study of valves and valve apparatus. The Editor is John Scott-Taggart, F.Inst.P., Member I.R.E., Author of "Thermionic Tubes in Radio Telegraphy and Telephony," "Elementary Text-book on Wireless Vacuum Tubes," "Wireless Valves Simply Explained," "Practical Wireless Valve Circuits," etc., etc., assisted by Paul D. Tyers, Author of "Construction of Wireless Receiving Apparatus," and by E. Redpath, Author of "Wireless Telegraphy and Telephony" (Cassell's "Work" handbook).

We cannot, for obvious reasons, give a list of the contents yet. We simply ask you to give your newsagent an **immediate** order to reserve you a copy.

It will be on sale everywhere, and delay in receiving a copy may result unless an order is given. Obtainable also direct from us, post free, 1/3.

Just Published :—RADIO PRESS " WIRELESS HANDBOOK AND DIARY, 1923."

A Charles Letts' Diary with 34 pages of general and 40 pages of special wireless interest. Beautifully bound in real leather.

PRICE, 2/6 NET. Or post free, 2/8 from

Radio Press Ltd. : : *Publishers of Authoritative Wireless Literature* : :
Devereux Court, Temple, London, W.C.2

THE WIRELESS WORLD EXCHANGE AND MART

TARIFF. Advertisements are accepted for this Section at the rate of twopence per word, with a minimum charge of two shillings. The advertiser's name and address will be charged for, and single letters and single figures will be counted as words. Compound words will be counted as two words.

DEPOSITS. All advertisements must be prepaid in the form of Postal Orders, the remittance being forwarded to Messrs. Bertram Day & Co., Ltd., 9 & 10 Charing Cross, S.W.1.

FOR SALE.

H.F. Transformer, 300-24,000 Eight tapings, 45s.—STONE, "Comnor," Woodcote Avenue, Wellington.

Six-Valve Receiver Amplifier, unit system, complete telephones, valves, honeycomb coils, Western Loud Speaker, £20. Seen by appointment.—NORRIS, Pyle Hill, Newbury.

Complete Valve Set, by Gamage. Single-valve panel, 3-coil holder, set six duolateral coils, 300-4,000 m., brand new, 40s.—WHITTAM, Railway House, Cookstown Co., Tyrone.

Handsome Four-valve Receiver, H.F. detector, two note magnifiers. Sloping panel mounted in oak cabinet, 2-4 valves may be used at will, separate rheostats, .0005 A.T.C., .0002 anode condenser. Perfect condition, trial given. Bargain, £12. Seen after 7 p.m.—CHAPMAN, 43, Bedford Court Mansions, Bedford Square, W.C.1.



WESTON MOVING COIL RELAYS,

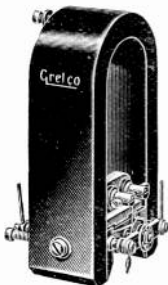

Undoubtedly the most Sensitive Relay made. Platinum Contacts, eminently suitable for wireless recording or Experimental work. Perfectly new as received from makers. Price, 20/- each. Packing and post, 1/6. Note: These originally cost the trade £8 to £10 each.

- Basket Coils (150 to 4,500 metres), excellent for telephony. Per Set 5/-
- Grid Leaks (enclosed), 2 meg. 1/-
- Aerial Wire, stranded, 7/25, 100' 3/-
- Filament Resistances 3/6
- Perikon Detectors on ebonite, complete with crystals 4/-
- Valve Holders, screwed legs 9d.
- Highly Glazed Green Egg Insulators. Best for aerials. 4d.
- Knobs, best quality, with 2 B.A. brass inset 4d.
- Siemens Halske Valves, excellent for amplifying and rectifying 7/6

All Goods dispatched the same day as order received.

Catalogue in preparation.

Postage extra.

Grafton Electric Company

Shoosrooms—54, GRAFTON STREET, TOTTENHAM COURT ROAD, LONDON, W.1. Telephone—Museum 241. Works—Slough.

FOR SALE—continued.

Marconi 16 Converted 2-Valve (H.F. and Det.), 400-25,000, £12 10s. Three-crystal carborundum detector, ebonite, 12s. 6d. Potentiometer, 5s. Loose coupler, ebonite, 2,500, £2 10s.—226, Barry Road, Dulwich.

Magnavox Junior Loud Speaker, new and unused, take £7 10s.—MARSH, 91, High Street, Bexley. Look at this. Loud Speakers, ex-Government 200 ohms, fitted on ebonite base with high-class 24-in. detachable aluminium horn. Bargain, 30s., carriage and packing extra.—WHITE, 121, Adelaide Road, Chalk Farm.

Variable Condensers, 25 plate, 14s. High tension batteries, 54 volts, 12s. Telephone transformers, 15s. Above while stock lasts. Any wireless parts supplied. Lowest price consistent with best quality.—PALMER & SUMMERFIELD, 46, St. Peter's Road, Handsworth, Birmingham.

Potentiometers.—Ex-Naval rheostats, 16 stud, 200 ohms easily adapted potentiometers—excellent condition—1s. 6d., few mounted, 2s. post free.—MONK, 4, Alma Road, Plymouth.

Experimenter, giving up, has for sale high and low frequency transformers, two- and three-valve sets ready for reception, £6 and £9, and a quantity of useful gear. Useful exchange considered.—KNIGHT, Police Station, Woodford Bridge, Essex.

Gamage Single-Valve Panel, one L.F. amplifier, one Auckland detector panel, and one (loose) coupler, 300 to 1,200, offers for the lot or singly.—38, Broadway, Grays, Essex.

B. A. Screws, Nuts and Washers, assorted gross 2s., lists 2d.—J. H. BENNETT, Station Road, Willesden Junction.

Massive Three-valve L.F. Det. Amplifier, in perfect order with telephones, £3 10s.—Write "P," 43, Denzil Avenue, Southampton.

E. Valves Moorhead, 10s. each. Osram, 14s. B. Valves Moorhead, 12s. each. B.T.H., 17s. 6d. each. All new and tested. Post free. Ebonite variometer rotor, 5s. each.—B. CALVER, 52, Linver Road, London, S.W.6.

Loud Speaker, mounted on polished mahogany base, 16" horn, with 4,000 ohm receiver. A bargain, 25s. Packing, etc., 1s. 6d.—WILLIAMS, 1, Allesley Old Road, Coventry.

Wireless Masts.—Light and Strong. Easily erected. Complete equipment, 16", 12s. 9d.; 12", 27s. 6d.; 45", 50s. Also parts and fittings. Stamp.—DERWENT MAST CO., 61, Arthur Street, Derby. Trade supplied.

Loud Speaker Horns, guaranteed perfect acoustics. Enamelled black matt, complete with polished aluminium base for receiver, 4s. 6d. Post, etc., 1s.—MIDLAND RADIOPHONE CO., Hearsall Works, Coventry.

Condenser Cases, finest quality teak, French polished, size 5 1/4 x 5 1/4 x 4 1/2, 3s. 6d. each. Other sizes proportionate, delivery from stock.—HITCHCOCK, Colchester.

Wireless Masts.—Improved Girder Type, light and strong, 30 to 50 ft. at 1s. 3d. ft.; 50 to 100 ft. at 1s. 9d. ft. Cash with order, carriage forward.—F. ARMSTRONG, Weybridge.

All Wireless and Electrical Goods stocked at 9, Colonial Avenue, Minories, near Aldgate Station. Handiest place for City buyers.—LESLIE DIXON & Co., Telephone No. Avenue 4166.

Huge Purchase of Ex-Government Wireless Stock.—Write for list giving full details. 150-watt dynamos, £1; loud speakers, 200 ohms, 7s. 6d.; 1" spark coils, 10s.; 1 1/2" spark coils, 12s. 6d.; Morse tapping keys, 3s., etc., etc., etc., etc. Three days' approval against cash, or please call. Write for detailed price list of all goods.—E. J. GALPIN, 16, Loampit Hill, Lewisham, S.E.13, London.

WANTED.

Wanted, Firms who are prepared to undertake manufacture of small turned brass parts suitable for wireless in reasonable quantities.—Box T.6, BERTRAM DAY'S ADVERTISING OFFICES, 9 and 10, Charing Cross, S.W.1.

HEATH & Co., Ltd.

Instrument Works, New Eltham, S.E.9 are prepared to undertake in their fully equipped works—Wireless Apparatus and Parts for the trade. Quotations given to Blue Prints. Immediate attention. Phone—Lee Green 301. Wire—Polaris, London.

Your Case Work

Let us quote you for your wireless casework. We are specialists in this class of work and feel sure our workmanship and prices will interest you.

Phone—L.W. 2720.

CARRINGTON & NEWBERRY LTD., 18/20, Normans Buildings, Old Street, E.C.

Wireless Poles

Gov. Surplus. Prime quality painted wood, 13", 1/11; 16", 3/6; sectional 27", 12/-; Iron Taper and Parallel Poles, 32", 30/-; 40", 35/-. Also stays, insulators, anchors, aerials. Enquiries solicited. Send stamp for list.

Jennings, Ltd., Wireless, Bristol.

BACON AND COATES, Radio Supplies Depot, Royal Arcade, Keighley.

SPECIAL THIS WEEK.

- Flash Lamp Batteries for H.T., new, doz. 5/6
- Flash Lamp Batteries for H.T., soldered 6/6
- 100' 7/22 Copper enamelled wire 5/-
- Aerial Insulators, non-hygroscopic, each 4d.
- Filament Rheostats, extra smooth, each 4/6
- H.F. Transformers, 300, 400 and 600 metres 3/9
- H.F. Transformers, formers only, each 2/3
- L.F. Transformers, tested 1,000 volts. . . 22/6
- Switch Arms, 4-ply copper 2/6
- Ebonite (guaranteed) 4/6
- Contact Studs and nuts 1/6
- Condenser Vanes, polished 1s.
- Condenser Washers, fixed vanes, doz. 3s.
- Condenser Washers, moving vanes, doz. 6d.
- Condenser Spindles, according to length. 6d.
- Condenser Screwed Rod 3/6
- Condenser Scales, engraved ebonite, each 13/6
- Condenser, complete, .0005 11/6
- Condenser, set of parts per set 6d.
- Sistoflex, strong 2/6
- Terminals doz. 2/6
- Dubilier Condensers each 2/6 and 3/6
- Do. Grid Leaks, 2 megohm, each 30/-
- Brown phones, new, 4,000 ohm, pair 4s.
- Stop Pins doz. 1/6
- Split Pins doz. 15/-
- Mullard ORA Valves, tested each 15/-
- B.T.H. Valves, tested each 6d.
- Polished ebonite knobs each 1/4
- Ebonite Valve Sockets, polished, screwed legs each 1/4
- Ebonite Valve Sockets, polished, with flange each 1/10

Orders over £2 carriage paid.

ALL WIRELESS AND NAUTICAL INSTRUMENT WORK HIGHLY FINISHED.

Complete Sets and Parts quoted for. Makers of "Broadwave" Receiving Sets. P.O. Registered No. 168.

MOORES & GRIFFITHS LTD., BEXLEYHEATH.

Phone, Bexleyheath 114.

THE WIRELESS WORLD EXCHANGE AND MART

Portland's Parts by Post. "EBONITE"

	s. d.		s. d.
4x4	1 3	12 x 7	5 2
7x5½	2 8	12 x 8½	6 5
8x6	3 0	12 x 10	7 6
9x6	3 5	15 x 8½	8 0
10x6	3 9	12 x 12	9 0
12x5½	4 2	17½ x 8½	9 6
9x8½	4 10	14 x 12	10 5
7x5	5 3	18 x 18(½-sheet) 12 10	
		36 x 18	21 3 0

7 lbs. .. £1 3 0 28 lbs. .. £4 0 0

No charge for cutting, waste or postage.

Delivery by return of post.

Quality A 1. DRILLING, manufacture—BRITISH.

Thickness One Quarter: Surface Mat.

JAMES PORTLAND

39, Sinclair Road, Olympia, W.14

N.B.—Mr. Portland stocks 200 Wireless Parts

Have you seen them ? Have you heard them ?

L.F. TRANSFORMERS.
The last word in efficiency. Price 21/- each

H.F. PLUG-IN TRANSFORMERS.
350-450 metres Price 8/6 each
900-1,100 metres Price 7/6 each

Manufactured at our Works.
Liberal discounts to the Trade.

P. H. BOYS & CO.,

Electrical and Wireless Engineers,
187, Goswell Road, London, E.C.1.

'Phone : - - - - - Clerkenwell 4454.

AGENTS WANTED.

Old-established London Firm, making one to five-valve broadcast receivers, desires provincial agents. Every assistance and good terms offered.—Box 76, c/o F. ALDRIDGE, 26, Paternoster Row, E.C.4.

Wireless Dealers throughout Great Britain are strongly advised to stock parts for making up wireless sets. Buy your parts direct from the factory at wholesale prices.—NEWTONIA WIRELESS FACTORY, 13 and 15, Whitcomb Street, W.C.2.

TRADE ENQUIRIES.

Manufacturers of Wireless Parts and Accessories are invited to send full catalogues, terms, deliveries, etc., to "WIRELESS," 29, Dewhurst Street, Cleckheaton, Yorks.

We will increase resistance of your ebonite panels, 1,000 fold by sandblasting. Inexpensive.—ALBEMARLE RUST PROOF CO., LTD., 10, Albemarle Street, Clerkenwell.

Working Drawings. Complete designs supplied for power and wireless. Works visited to advise. Exclusive designs if desired.—PUCKLE, Buckhurst Hill, Essex. Telephone, Woodford 400.

SITUATIONS VACANT.

Managers Required by leading firm of telephone and radio apparatus manufacturers for branches in Birmingham, Newcastle and Glasgow. Must have good commercial training and technical knowledge. Reply in confidence fully stating experience, age and salary required to Box K.8, BERTRAM DAY'S ADVERTISING OFFICES, 9 and 10, Charing Cross, S.W.1.

Experienced Advertisement Copy Writer for well-known wireless firm. Applicants must have technical and practical knowledge of wireless sets and component parts.—Box K.9, BERTRAM DAY'S ADVERTISING OFFICES, 9 and 10, Charing Cross, S.W.1.

Thanks.—Box O.3 thanks all applicants. Position now filled.

SITUATIONS WANTED.

Energetic well-trained wireless worker, with experience, seeks position with wireless firm, any capacity, good telegraphist.—JOHNSON, Wath, Pateley Bridge, Yorkshire.

MISCELLANEOUS.

Telephone Receivers rewound up to 1,000 ohms, 5s. each; 2,000 ohms, 7s. 6d. each; cash with order.—M. E. HAMPSHIRE, 139, Sydenham Rd., S.E.26.

East Ham, Wanstead, Ilford, Manor Park and Forest Gate. Amateurs should not fail to come to the RADIORENDEZVOUS, 709, Manor Park Broadway (over Liptons). Club open till 10 p.m. nightly.

Telephones Rewound to any Resistance. Telephone re-windings a speciality. 11s. to 4,000, 12s. to 8,000. Returned 24 hours. Cash with order.—MAGNETO SERVICE CO., 4, Newington Causeway, S.E. Hop. 2627.

REPRESENTATIVE.

District Travelling Representatives required by substantial wireless firm offering wireless sets at competitive prices. Those confident of obtaining good business should write, stating qualifications and district covered. London not available. Commission basis.—Box B.Y.Z., BERTRAM DAYS' ADVERTISING OFFICES, 9 and 10, Charing Cross, S.W.1.

BOOKS.

Radio Magazines, all the latest, "Radio World," 10d.; "Popular Radio," 10d.; "Radio Broadcast," 1s. 6d.; "Radio News," 1s. 6d.; "Science and Invention," 1s. 9d.; "Scientific American," 2s. 6d. Post free.—INTERNATIONAL NEWS COMPANY, LTD., 15, Bream's Buildings, London, E.C.4.

Wireless Insurance!

LIVERPOOL MARINE AND GENERAL INSURANCE CO., LTD.

London Office: 7, Angel Court, Throgmorton St., E.C.2.

FIRE. ACCIDENT. MARINE.

Write for particulars of our SPECIAL WIRELESS POLICY (Annual Premium 7/6) which covers fire and other damage to the complete Wireless Set and also indemnifies the Owner against claims arising from damage to property or persons through the breakdown of outside aerial and its supports.

ALL BRITISH PHONES

21s. per pair. Post Free. (4,000 ohms)

Illustrated Catalogue including List of Stations, 6d. Post Free.

EONS WIRELESS SUPPLY Co.,
:: :: 115, Fleet Street, E.C.4. :: ::

WIRELESS CABINETS

PROMPT DELIVERIES
COMPETITIVE PRICES

PICKETT BROS.,

Albion Rd., BEXLEYHEATH, S.E.

VERNIER TYPE.

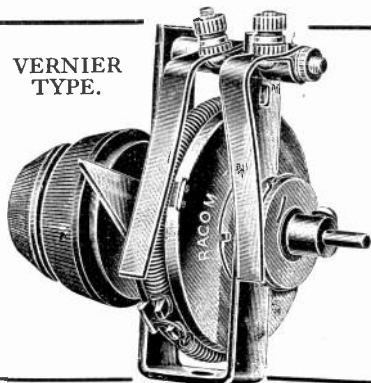

RADCOM Filament RHEOSTATS

Features: PANEL MOUNTING ½" to ¾"
Positive Stops at zero and full resistance.
Single Turn Control. Smooth and Quiet. Guaranteed.

PLAIN TYPE for Amplifying Valves - 5/-

VERNIER TYPE for Detector Valves 7/6

Radcom Coils, Tuners, Transformers, Accumulators.
London, Manchester and Birmingham are broadcasting NOW!

Radio COMPONENTS LTD.

12/13, Henrietta St.,
LONDON, W.C.2

Telephone: Gerrard 792
Telegrams: Radponents, Rand. London

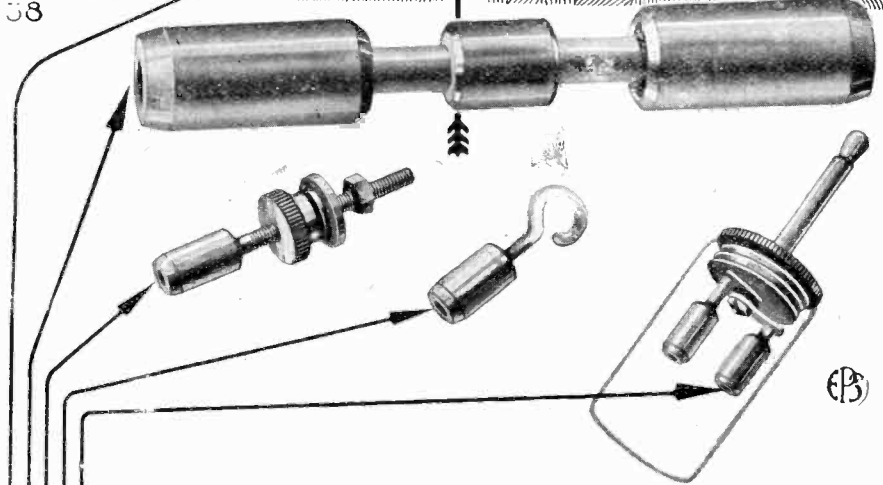
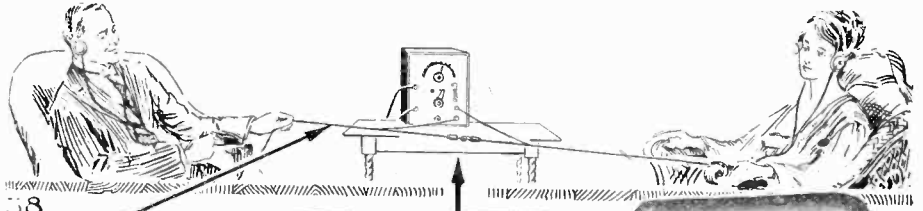
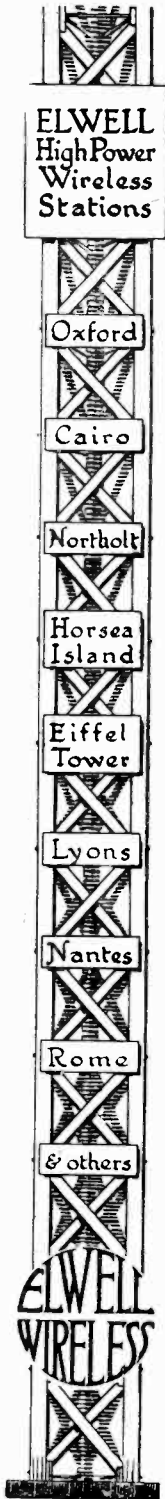

- (1) The self-tightening bull-dog grip fitted to the Elwell plug enables telephones or loud speaker connections to be changed in a moment.
- (2) By the terminal adaptor, the bull-dog grip connector can be added to any existing terminals.
- (3) For fitting to the face of a panel this pattern is recommended. It combines a standard terminal for fixed connections with a bull-dog fitting for connections which you require to change.
- (4) A series connector with a bull-dog grip at each end. Invaluable for connecting telephones in series.
- (5) The series connector in use. Telephones can be connected in series in an instant. No amount of pulling can break the connection. It thus avoids those annoying interruptions caused by involuntary movements.

Bull Dog Grip Connectors.

Elwell patented self-tightening grip fittings are a big convenience. Without soldering, tightening of nuts or screws or the use of any tools whatever, electrical connections can be made, broken or changed in a moment.

Moreover, the connections when made are electrically perfect and self-tightening. **The more you pull them the tighter they grip.** But they can be released in a moment when desired.

Ask to see them at your wireless dealer or write for descriptive leaflet.

C. F. ELWELL, LTD., *Radio Engineers,*
 CRAVEN HOUSE, KINGSWAY, LONDON, W.C.2
 Telephone : REGENT 421.



HANG IT!

Hang this up-to-date and very complete directory of wireless telephone and telegraph call-signs from your table. Over 12,000 call-signs of amateurs, ships and land stations. As indispensable to a listener-in as an ordinary telephone directory is to a subscriber.

PRICE, 2/6 net.

Obtainable through the usual channels or direct (post free, 2/3) from—

Radio Press Ltd., *Publishers of Authoritative Wireless Literature,*
 DEVEREUX BUILDINGS, STRAND, LONDON, W.C.2

NEW SUPPLY JUST RECEIVED FROM THE PRINTERS.

THE RADIO EXPERIMENTER'S HANDBOOK

By **PHILLIP R. COURSEY**,
 B.Sc. (Eng.), F. Inst. P.

113 pages. 99 Diagrams and Illustrations.

PRICE **3/6** NETT.
 (Postage 6d.)

CONTENTS—

General Considerations—Components of Wireless Installation—The Aerial Circuit—Receiving Tuners—Receivers, including detailed instructions on the making of the many types of inductances and useful Mark III tuner modifications, Amplifiers and Valve Detectors with circuits of high-frequency, low-frequency and resistance—Capacity Coupled Amplifiers—Heterodynes, giving working instructions for making up a long range heterodyne wavemeter—Appendix: High Frequency Measurements and Calculations with valuable data and tables.

The Wireless Press, Ltd.

Dept. W.W.

12-13, Henrietta St., Strand, London, W.C.2

ACCESSORIES FOR PRIVATE WIRELESS INSTALLATIONS



TELEPHONE HEAD SETS

specially designed for wireless work. Terminals enclosed to prevent receiving circuit being interfered with. Earpieces are provided with groove on surface to minimise condensation of moisture.

SWITCHES for series-parallel switching of condensers, adding to or reducing the number of valves in simultaneous use, etc.

VACUUM PROTECTORS (for protecting the aerial). They secure protection against risk of fire or damage by lightning. Will operate many times before renewal is necessary.

AERIAL WIRES & INSULATORS, EARTHING DEVICES, FUSES, JACKS & PLUGS, H.T. BATTERIES.

ALSO MANUFACTURERS OF **BROADCASTING WIRELESS RECEIVING SETS**

Descriptive pamphlet and prices on application to

SIEMENS BROTHERS & CO., LTD.

General Offices and Works:

WOOLWICH, LONDON, S.E. 18

Telegrams—Siemens, Woolwich

Telephone—City 6400

And at Belfast, Birmingham, Bristol, Cardiff, Glasgow, Leeds, Manchester, Newcastle, Sheffield, Southampton.

1923

Everyone needs a
Diary!

This one meets the
needs of everyone
who is interested
in WIRELESS

**NOW
ON
SALE**



*BEAUTIFULLY
BOUND IN
REAL LEATHER*

The Radio Press WIRELESS HANDBOOK AND DIARY

Edited by PAUL D. TYERS

Price **2/6**

(2/8 Post Free)

In addition to a Lett's Diary containing the usual Calendar, Diary, and 30 pages of useful information, there are 40 pages of interesting and useful Wireless data and diagrams

- | | |
|-------------------|---------------------------|
| Resistance Values | Practical Units |
| Aerial Data | Re-charging Accumulators* |
| Definitions | Electrical data |
| Inductances | Special Formulæ |
| Orthodox Signs | Special Valve Circuits |
| | etc., etc. |

A REALLY USEFUL XMAS GIFT

JUST PUBLISHED!

Practical Wireless Valve Circuits. By John Scott-Taggart, F. Inst. P. A book which should be in the hands of everyone possessing a book on valves. **2/6 net.** Post free, 2/8

All our Publications obtainable through the trade or direct from

Radio Press Ltd., DEVEREUX COURT
TEMPLE, LONDON
W.C.2.

TO THE TRADE

EBONITE - SHEETS - RODS

COPPER WIRE - STANDARD GAUGES

AERIALS - SLEEVING, &c.

CABLES & ELECTRICAL SUPPLIES.

MICA HOUSE, OFFORD STREET,
CALEDONIAN ROAD, LONDON, N.1.

Telephone:
North 805.



**TUBE, SHEET,
WIRE, STRIP,
ROD & CASTINGS**

IN

**PHOSPHOR BRONZE,
COPPER, BRASS, &c., &c.**

**CHARLES CLIFFORD & SON, LTD.,
BIRMINGHAM.**

"BROADCO" Sets

BROADCAST WIRELESS Co., Ltd.

2, Tower Royal, Cannon St., E.C.4.

Send for descriptive Catalogue and Terms.

SPEARS and COMPANY
FOR

TERMINALS

SCREWS, NUTS, WASHERS, PLUGS and SOCKETS, CONTACT STUDS, BUSHES, VALVE LEGS, CONDENSER VANES and TURNED and PRESSED PARTS OF EVERY DESCRIPTION.

Actual Manufacturers to TRADE ONLY

We regret we cannot supply small lots to Amateurs.

Write for Illustrated List.

CAPSTAN REPETITION WORKS, PARK ROAD, HOCKLEY, BIRMINGHAM
Telephone : 3265 Central. Telegrams : "Firettes," Birmingham

BROADCASTING RECEPTION SETS

One-Valve Set, Complete for Working £7 10s.

Passed for
Broadcasting
Licence
G.P.O. No.
1038.

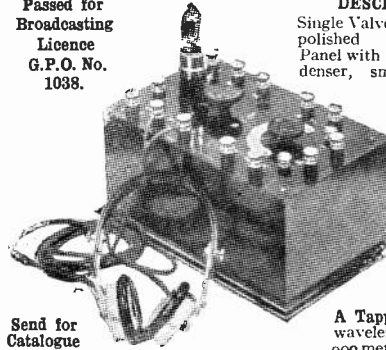

DESCRIPTION.

Single Valve, mounted on polished $\frac{1}{2}$ " Ebonite Panel with Variable Condenser, smooth acting resistance, grid leak and condenser and all terminals clearly engraved in white, in a Mahogany Polished Cabinet, 9" x 5" x 5"

£3 15s.

Send for Catalogue

A Tapped Coil for wavelengths up to 900 metres with 2 terminals for coils for any higher wavelengths. The coil is enclosed and the tappings are brought out to an 8-way switch mounted in the front of the cabinet.

ACCESSORIES INCLUDED :

- Siemens' 54 volt high-tension battery with plugs for altering the voltage 15s.
- 4 Volt 50 Amp. hour low tension accumulator in case with carrying strap £1 4s.
- One pair of sensitive head 'phones of 4,000 ohms resistance £1 1s.
- One detecting valve 15s.

Total £7 10s.

Satisfaction Guaranteed or money refunded.

WIRELESS INSTALLATIONS LTD.

15, ALDERSGATE STREET, LONDON, E.C.
Agents Wanted.

W. A. C. SMITH
236, Argyle Street,
GLASGOW,

are Sole Scottish Agents for the
Famous Burndept Receivers

THE WIRELESS AGE

THE AMERICAN MONTHLY JOURNAL OF WIRELESS TELEGRAPHY AND TELEPHONY

A "Go-ahead" Magazine for Operators and Amateurs.

Sole European Agents : THE WIRELESS PRESS LTD., 12-13 Henrietta St., Strand, London, W.C.2

WIRELESS TRAINING

Most thorough training in Wireless Telegraphy or Telephony given under ideal conditions.

Special Postal Course for Amateurs.

—Prospectus Free.—

WIRELESS APPARATUS

Complete stocks of all Wireless Instruments and Accessories. Prompt Deliveries. List 1½d. stamp.

WIRELESS COLLEGE COLWYN BAY

Questions and Answers COUPON

To accompany Questions sent in during the week commencing Dec. 23rd, 1922.

VOL. XI, NO. 12.

See Conditions on Page 416.

It Speaks for itself—

and in no uncertain voice

THE WORLD'S STANDARD LOUD SPEAKER

AMPLION

WIRELESS
LOUD
SOUNDING
RECEIVERS
are supplied
in a series of
Ten Models
Suitable for
every service :
The Home,
Laboratory
and the
Concert Hall



At Prices
ranging from
£2:10:0
to
£15:15:0

**DAILY
DEMONSTRATIONS**
at the
**GRAHAM
SHOWROOMS**
The
**ALGRAPHONE
SALON**
25-26 Savile Row
Regent St., W.1
Phone : Regent 1075.

" MUSIC MASTER " HORN

Type AR 13, 120 ohms **£6:0:0**
Type AR 15, 2,000 ohms **£6:2:6**

" Graham " Wireless
Productions include
" High Efficiency "
Telephone Headsets
of improved design
and construction.
The " Graham " is
the best Head Gear
Money can buy.

Full Particulars for-
warded upon request.
Ask for Folder W.W.

Patentees and Manufacturers :
**ALFRED GRAHAM
AND COMPANY**
St. Andrew's Works, Crofton Park
LONDON : : S.E.4

Phone : Sydenham 952.
'Grams : Navahada, Brock, London.

SCOTLAND—
Mr. F. M. Milligan,
25, Renfrew Street,
GLASGOW.

IRELAND—
Mr. Alex. R. Munday,
41, Chichester Street
BELFAST.

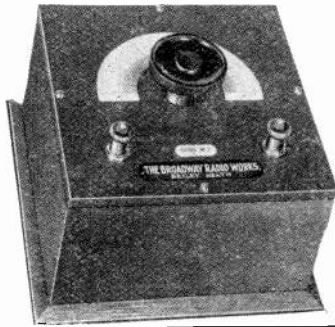

Specification of our well-known CONDENSERS. Highest grade Aluminium Plates, Brass Washers machined to a limit of + or - '001" Adjustable Brass Bush at bottom, Fixed Brass Bush at top. These Condensers are built to stand HARD continuous usage and we GUARANTEE THEM.

M.F.	Value in M.F.	Panel Mounting in Parts	Panel Mounting Assembled	Cabinet Mounting in Parts	Cabinet Mounting Assembled	Cabinet Mounting Assembled in Cabinet	Polished Mahogany Cabinet.
.0015	..	23/-	25/6	24/-	26/6	33/-	6/3
.001	..	16/9	19/6	17/9	21/-	26/-	5/6
.00075	..	13/6	16/3	14/6	16/6	22/-	5/6
.0005	..	10/6	13/-	11/9	13/9	18/-	4/6
.0004	..	10/-	12/6	11/-	13/3	17/6	4/6
.0003	..	9/-	11/6	10/-	12/-	16/-	4/-
.0002	..	7/-	9/-	8/-	9/6	13/6	4/-
.0001	..	6/-	8/-	7/-	8/6	12/6	4/-
Vernier	..	—	4/6	—	5/-	9/-	3/6

Fitted with Bevelled Ebonite Dial 1/9 extra. Special Sizes made to Order. Price list on request. ALL SUNDRIES AND COMPONENTS IN STOCK. ORDERS OVER 20/- CARRIAGE PAID. TRADE ENQUIRIES SOLICITED.

THE "BROADWAY" RADIO WORKS
DEVONSHIRE ROAD, BEXLEYHEATH, KENT.

FILTRONS

(Patented)

Eliminate ANÆMICS and DISTORTION

BY USING A

Variable Grid Leak

Refinement in the reception of Radio Telephony necessitates extreme critical control of the Grid potential.

The accumulations of electrons on the grid must be definitely filtered away in precise Syncopation with the input modulations to ensure purity of conversion from Radio to Audio frequency.

YOU WILL BE ASTOUNDED BY THE IMPROVEMENT,

5/- VARIABLE 5/-
GRID LEAK

Post free to any part of the U.K.

Post free to any part of the U.K.

Postal Orders and cheques to be crossed and made payable to—

Radio Specialities
57a, Denbigh Street, PIMLICO, S.W.1.
TERMS.—CASH WITH ORDER.

Extracts from our Catalogue

3d. Post Free.

BRITISH MADE. HIGH CONDUCTIVITY COPPER WIRES. Thousands of Miles in Stock. Best Quality Coverings.

Per lb.

S W.G.	Yds. per lb.	Ohms per 1,000 yds.	S.C.C.	D.C.C.	S.S.C.	D.S.C.	Enmid.
12	10	2.9	1/10	1/11	—	—	—
14	18	4.8	1/11	2/-	—	4/2	—
16	26	7.5	2/-	2/1	—	4/4	—
18	48	13.3	2/1	2/2	—	4/8	1/11
20	84	24	2/2	2/3	—	—	2/4
22	140	39	2/6	2/11	—	—	2/6
24	239	63	3/-	3/6	—	—	2/8
26	340	95	3/7	4/1	—	8/-	3/2
28	530	140	4/4	4/8	—	9/-	3/6
30	718	200	5/-	5/6	—	10/-	3/10
32	950	262	6/-	7/3	—	12/6	4/2
34	1,300	362	7/-	8/3	—	13/6	4/4
36	2,000	530	8/8	10/-	13/-	15/6	4/8
38	3,000	850	11/3	13/-	16/-	19/-	5/3
40	4,800	1,330	15/-	17/6	20/-	22/8	7/6

Per Oz.

42	7,000	—	1/-	1/4	1/9	2/-	8d.
44	11,000	—	—	—	3/-	3/6	1/3
47	27,000	—	—	—	6/-	7/6	3/9

Pro Rata. Allow for Spools, 3d. extra.

J. L. Cartwright & Co.

(Dept. W.), 24, London Road, Manchester.
Phone, 3entral 4209. Works, Berry St. Grams, "Pladuram, Manchester."

THE AUDIOPHONE

EMPLOYING THE UNIT SYSTEM.

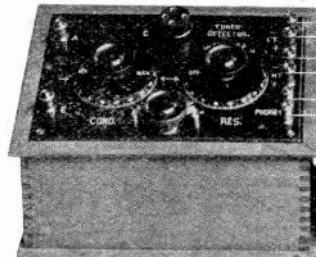

SPECIFICATION.

Highly skilled hand labour throughout. Bare, tinned internal wiring, bent on formers, and soldered at all connections, thus ensuring a noiseless circuit. Polished ebonite panel, engraved white. Polished mahogany cabinet. Wavelength range 300-550 m.

P.M.G. Reg. No. 1018.

TUNER DETECTOR.

Price as shown £7 7s.
Price complete:—H.F., L.F. Phones, M.O. Valve, and Aerial Wire and Insulators £12 3s.

Prices include Marconi Royalty and commission to B.B.C.

TERMS. Cash with order, or five days' approval against full deposit.

Higher wavelengths obtained by means of plug-in-coils. Fully approved by P.M.G.

IMPORTANT: Fixed Reaction is a feature of this Receiver.

Manufactured under Marconi Licence by—

J. R. WRIGHT
10, Carton Street, Baker Street, W.1



Spend Xmas with the CLEAR SPEAKER Peto-pan

DON'T be selfish—let everyone listen to the music you are getting from your Radio Set.

The Peto-pan is not just a horn fitted to a telephone ear-piece—it is a real Clear Speaker. Purity and clarity of tone have been the ideals aimed for, *not sheer volume*. The result is a perfect reproduction of every word and of every note absolutely free from blur or distortion.

Featherstone House,
64, High Holborn,
W.C.1

If other Loud Speakers have disappointed you, listen to the Peto-pan—you will be pleasantly surprised.

Exclusive Features: A diaphragm at least twice the size of the ordinary ear-piece, adjustable for pitch of note by means of one screw.

If for use with Broadcast Licence the Peto-pan must stamped B.B.C. at an extra cost of 3/-

50/-



“For they are jolly good Fellows”

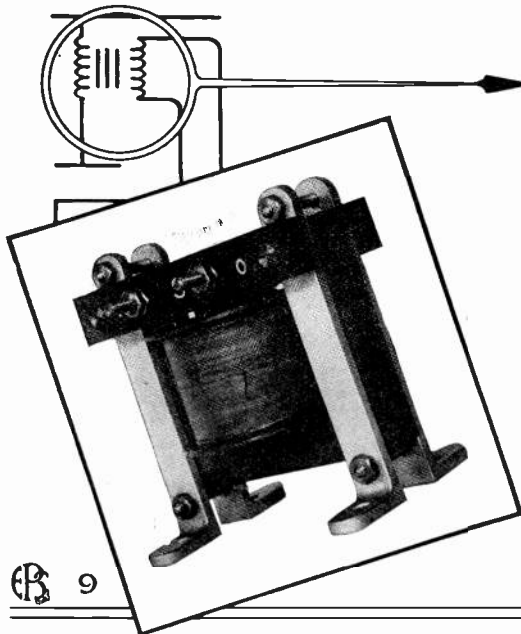

INTERVALVE TRANSFORMERS

Use Fellows Intervalve Transformers, and secure maximum amplification with freedom from distortion and extraneous noises.

British made throughout and guaranteed.

22/6 (Postage 6d.)

FELLOWS MAGNETO CO., LTD.
LONDON, N.W.10.

Telephone:
Willesden 1560-1.

Telegrams:
Quixmag, Phone, London



ANNOUNCING

that the famous

BRANDES 'MATCHED TONE' HEADSETS

Standard equipment of the best Radio Receivers since 1908, and which are unrivalled in sensitiveness, durability, and accuracy of construction, are now made and sold in England by

CANADIAN BRANDES LIMITED
105, Great Portland Street, London, W.1
Trade enquiries invited.

Simple Explanatory Books on Wireless

The ABC of Wireless

The Book for the "Man in the Street"

BY
PERCY W. HARRIS

This wonderful little book has been specially prepared for those who are desirous of getting a good knowledge of wireless without delving into text books.

**WHAT IS WIRELESS
HOW DOES IT
WORK
?**

The ABC will tell you

An evening spent in reading this book will put you in a position to appreciate to the full the wonders of the latest and greatest of sciences.

NO Technical Expressions to Puzzle over.
NO Hard Thinking to be done.
NO Mathematical Formulae to be elucidated.

Price **6^{d.}** net. Post free **8^{d.}**

The Wireless Telephone

What It Is, and How It Works

BY
PHILIP R. COURSEY, B.Sc. (Eng.), etc.

There are many possessors of Wireless Receiving Sets who do not understand the Wireless Telephone and how it works.

Although small, Mr. Coursey's book deals with the subject very thoroughly, and for those who have not the available time to study text books, it will be found of great value.

It is written in simple language, plentifully supplied with drawings and photographs which render the reading of the work interesting and easy.

The last Chapter tells how to build a Broadcast Receiver. All interested in Wireless Telephony should read this book.

Price **2/6** net. Post free **2/10**

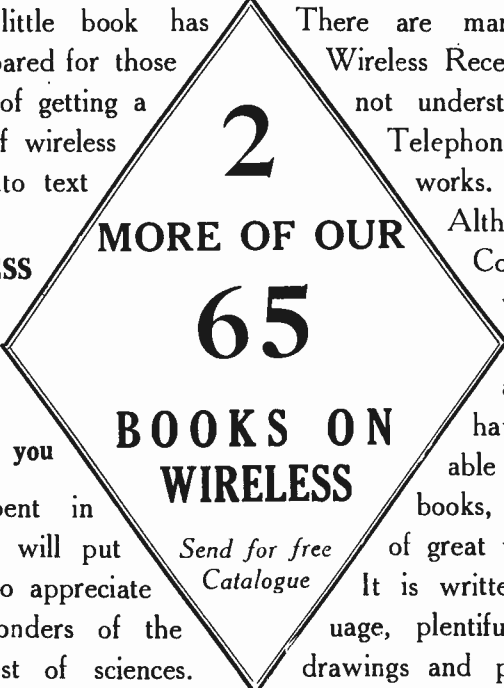

THE WIRELESS PRESS LIMITED
12/13, Henrietta Street, Strand, London, W.C.2



AN ENTIRELY NEW WORK.

The ABC Telegraphic CODE 6th Edition

FIVE-LETTER CODE.

An up-to-date Work, containing Five-letter Artificial Code Words with at least a TWO-letter difference and a **TERMINAL-INDEX** of the words at the end of the Book.

Cost of Cabling Brought to a Minimum :: Simple to use.

PRICE **£3 3s. 0d.** net (U.K. and Colonies.)

Inland Parcel Postage 1/6 per copy. Continental Book Post 2/- per copy.

Publishers—

EDEN FISHER & CO., LTD., 6, 7 & 8, Clements Lane, E.C.4
And 95, 96 & 97, Fenchurch Street, London, E.C.3.

Revised and Enlarged Edition

AMATEURS This is just what you want

THE VEST POCKET
DICTIONARY

OF

TECHNICAL TERMS

USED IN

WIRELESS WORK

By Harold Ward

Over 1500 definitions

Price **2/6** net. Post free **2/9**

The Wireless Press, Limited

Dept. W.W.

12-13, Henrietta Street, Strand, London, W.C.2

The Construction of Amateur Valve Stations

By **ALAN L. M. DOUGLAS**

78 pages. 55 Diagrams and Illustrations.

PRICE **1/6** NET.

(Postage 2d.)

The aim of the author in compiling this volume has been to place within the reach of the amateur who is interested in Wireless Telegraphy and Telephony a Handbook which will enable him to obtain data that he has otherwise difficulty in acquiring, in order that he may construct for himself apparatus which he desires to make, but does not quite know how to design correctly.

The Wireless Press Ltd.,

12/13 Henrietta St., London, W.C.2

Registered "NIPHAN" Trade Mark

WATER-TIGHT PLUGS
and **CABLE COUPLINGS**
TO MEET HOME OFFICE REQUIREMENTS



COUPLING CONNECTING CABLES

Phones:

2600 Gerrard 12061 Central.

Telegrams:

"Niphon, London."

Patented in England and Abroad.

As used by H.M. War Office, Electric Supply Companies, Railway Companies, Marconi's Wireless Telegraph Company

SIMMONDS BROS., LTD.

4, 6 & 8, NEWTON STREET, HOLBORN, W.C.

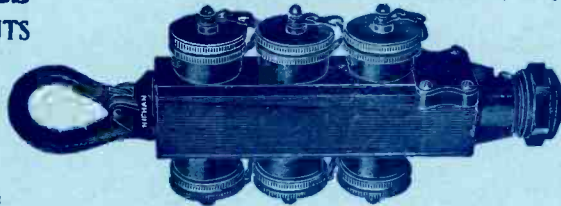

SIX WAY TEE CONNECTORS

Components

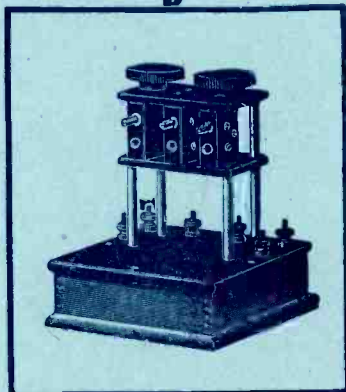

*Every Article
made by
Auckland's
is in a Class
by Itself.*

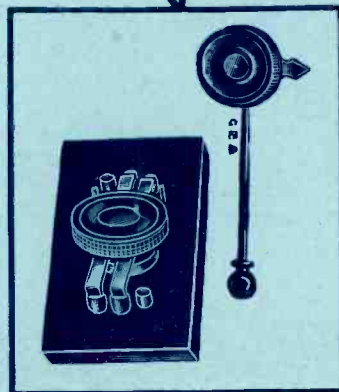

Series Parallel Switches 4/6
Table Coil Holder 3 way 18/-
" " " 2 " 15/-
Fil. Resistances 3/9
Interval Transformers 20/-
Igranic (Auckland)
Coils from 5/-

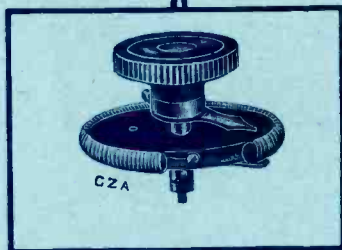

CATALOGUE FREE

Telephone Transformers 13/6
" " Mtd. 17/6
Extended Knobs and
Pointer 1/6
Condenser Dials and
Knob 3/9
Coil Plugs 1/6
Fibre Strip 4' 6" 1/-
Uni Wave Slabs—Set.. 12/6
Grid Leak and Con-
denser 4/6
Pin Type H.F. Trans-
former for Broadcast 5/-

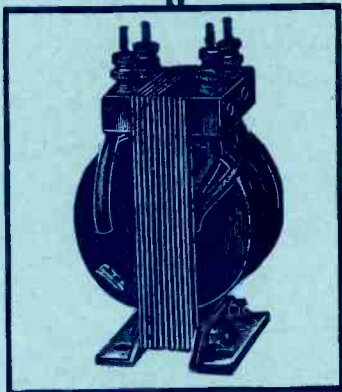
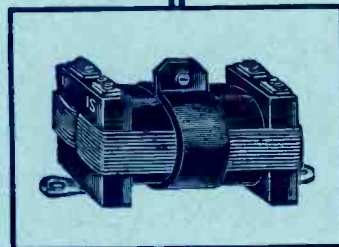

We carry stocks of all makes of H.T. Batteries, Phones and Valves, and supply from stock.

Why not make use of our World Wide Service? It will pay you, especially if you say

*“Auckland
Products”*

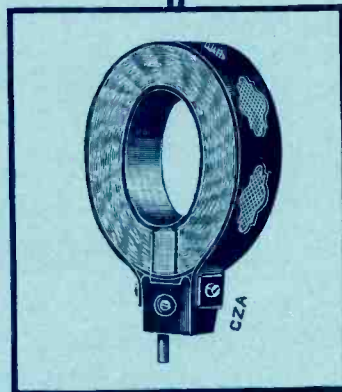

G. Z. AUCKLAND & SON, 395, St. John Street, E.C.1
Factories—ISLINGTON, N. WIRELESS INSTRUMENT MAKERS 'Phone 3178 CLERKENWELL

Printed by Sanders Phillips & Co., Ltd., Chrystell Road, London, S.W.9, for the Proprietors and Publishers, The Wireless Press, Ltd., 12-13, Henrietta Street, London, W.C.2; Sydney, N.S.W., 97, Clarence Street; Melbourne, 422-24, Little Collins Street; New York, 326, Broadway.

Review

WIRELESS WORLD

AND

RADIO REVIEW

No. 176. [No. 13. VOL. XI.]

30th DECEMBER, 1922.

Registered at the G.P.O. as a Weekly Newspaper.

Doing away with the aerial

When there is electric light, an aerial is unnecessary. Plug a "Ducon" into an ordinary lamp holder or wall socket; connect to the wireless receiver and you will receive the broadcasting perfectly.

The "Ducon" gives satisfactory results with all types of receivers, from crystal to multi-valve.

Dealers not yet stocking are invited to write for trade terms. Obtainable from all leading wireless dealers, electrical contractors and stores or direct from the makers.

Over 50,000 in use.

DUCON 10%

The DUBILIER CONDENSER Co. (1921) Ltd.

Ducon Works, Goldhawk Road,
SHEPHERD'S BUSH, LONDON, W.12.
Telephone Hammersmith 1084.
Telegrams "Hivoltecon. Phone London."





STERLING No. 1 CRYSTAL RECEIVING SET

Specially designed for use in connection with the Wireless Telephony Broadcasting Scheme, and is suitable for a range of about 25 miles.

PRICE £7-12-6

TO BE OBTAINED FROM ALL
DEALERS OR DIRECT FROM:-

**STERLING TELEPHONE
& ELECTRIC CO., LTD.**

210-212, Tottenham Court Road,
LONDON : : : W.1

Telephone No. : 4144 Museum (7 lines)

Telegrams : "Cucumis, Wesdo, London."

Works : DAGENHAM, ESSEX.

BRANCHES:

NEWCASTLE-ON-TYNE 9, Clavering Place.
CARDIFF : 8, Park Place

We guarantee that all Broadcast Radio Apparatus sold by us conforms with the conditions of the Broadcaster's Licence issued by the P.M.G.

IMMEDIATE DELIVERY

VULCANIZED FIBRE

SHEETS

(0.10 - 2")

RODS

(1/8 - 2")

TUBES

(1/8 - 4")

PANELS, CONDENSER TOPS,
KNOBS, INSULATING BUSHES,
TRANSFORMER BOBBINS,
SWITCH & TRANSFORMER BASES,
FIL. RES. FORMERS, WASHERS,
TUBES FOR INDUCTANCES etc.

THE MANUFACTURERS.

DIAMOND FIBRE CO. LTD.

DIAMOND - FIBRE
WORKS,

HIGH ROAD
SOUTH TOTTENHAM, N.15.

H.P.R. HILOPHONE

(1 HIGH FREQUENCY
1 DETECTOR AND 1
LOW FREQUENCY)
(300 to 1,000 Metres.)



REG. P.O. No. 0177.

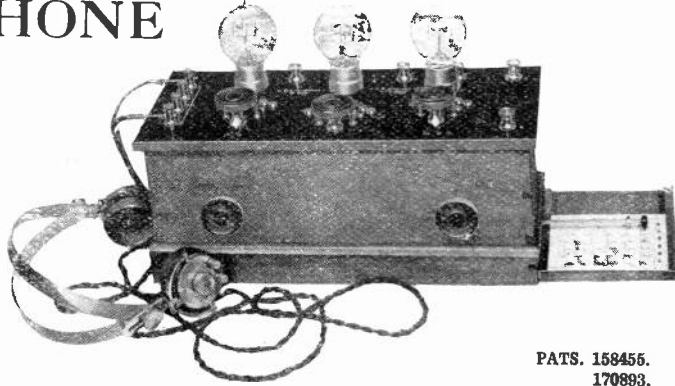

PATS. 158455.
170893.

Broadcast Receiver with Variable Reaction

THE introduction of Variable Reaction into the circuit very greatly increases the effective radius of the instrument, raises the strength of reception equivalent to the addition of extra Magnifying Valves and enables Continuous Wave Morse signals to be received. The local oscillations do not cause any interference and the instrument is approved by the P.M.G. for use under a Broadcast licence obtainable at any P.O.

The efficiency of the Hilophone for all British Broadcast Telephony is, we believe, as high as it is possible to secure with three valves.

Full directions for its use with each instrument.

PRICE —Without accessories	£25 : 0 : 0
British Broadcasting Company's charge	2 : 5 : 0
		TOTAL	£27 : 5 : 0

or			
Complete with three valves,			
6-volt accumulator, 50-volt High			
Tension Battery, one pair of			
Headphones, and aerial	...		£34 : 0 : 0
British Broadcasting Company's			
charge	2 : 5 : 0
			£36 : 5 : 0

H.P.R. WIRELESS LIMITED

Pioneer Designers and Makers of Fine Valve Receiving Instruments for Amateurs

HEAD OFFICE AND DEMONSTRATION ROOM:
CARLTON HOUSE, GREAT QUEEN STREET,
KINGSWAY, LONDON, W.C.2

Tel. : Regent 1719.

(Opposite Kingsway Theatre.)



TYPE F. "Featherweight."
Actual weight, including cords,
is 6ozs. only.

BROWN'S

"Featherweight"

HEADPHONES

British and Best

The Finest Headphones Procurable for

30/-

This price is for one pair of either
120 or 4000 ohm 'phones, including
cords of good quality.

Catalogue Post Free.

Head Office and
Works:
Victoria Road,
North Acton, W.3

S. G. BROWN, Ltd.

London
Showrooms:
19 Mortimer St.,
London, W.1

The London Telegraph Training College, Ltd.

Telephone: WESTERN 2696.

Morse House, Earl's Court, S.W.

ESTABLISHED 25 YEARS

OFFICIALLY RECOGNISED BY THE WAR OFFICE AND POST OFFICE AUTHORITIES
CABLE AND WIRELESS TELEGRAPHY.

PARENTS desirous of placing their sons in either of the above Services and of affording them the best training facilities should apply for particulars of Courses and the methods of instruction which place this Institution in the first rank. Cable Telegraphy offers at the present time excellent prospects to youths from 15 years of age and upwards, and the College has exclusive facilities for obtaining posts for qualified students in the leading Cable Companies at commencing salaries of £150 to £300 per annum, with yearly increments of £12 to £25, and ultimate possibilities of obtaining positions as Supervisors, Assistant Superintendents, Managers, etc.

In the Wireless Telegraph Service the commencing remuneration at the present time is approximately £150 per annum, and operators when qualified are nominated by the College for appointments as and when they occur. No correspondence classes or branches.

DAY AND EVENING CLASSES.

Prospectus containing all information will be forwarded on application to THE SECRETARY (DEPT. H.), 262, Earl's Court Road, Earl's Court, London, S.W.5.

Sole Proprietors of the "Scott" Training Disc, which contains useful formulæ and other information for Wireless Telegraph Operators and is invaluable to Army Signalling Officers for range finding, etc.

Price, complete with instructions for use 1/- Postage 2d.

"WESTERN COUNTIES" ACCUMULATORS

Write for Complete
Price List.

FOR WIRELESS USE

Write for Complete
Price List.

The most Reliable and Moderate Priced Accumulator on the Market.

4 Volts.		6 Volts.		The Western Counties Electrical & Engineering Company, Midland Bank Chambers, Yeovil
80	amphours £1 8 6	60	amphours £1 17 6	
120	" 1 17 6	90	" 2 5 0	
150	" 2 5 6	120	" 2 12 6	
180	" 2 19 6			

Packed in non-returnable boxes charged at 9d. each.

Branch for Messrs. BURNDIPT LTD.

Telegrams — "Electron, Yeovil"
Telephone — 223 Yeovil

BURNDEPT Accessories

BURNDEPT Rheostat

THIS Rheostat, which is fitted to all Burndept apparatus, has been designed to embody efficiency in action with simplicity in fitting. A special feature enables the tension on the phosphor bronze brush to be adjusted so that a silky smooth movement, combined with perfect electrical contact can be ensured. Can be fitted to panels from $\frac{1}{8}$ " to $\frac{3}{8}$ " thick by drilling one $\frac{1}{4}$ " and two 6 B.A. clearance holes. The resistor element is mounted on a fireproof former to which is moulded the stop, engaging the phosphor bronze brush in off and full on positions—this brush is riveted to the rotating spindle. No. 271. PRICE 5/-.

No. 275. Mounted and boxed, PRICE 12/6.

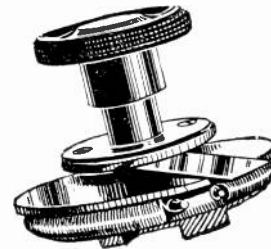

BURNDEPT Coils

BURNDEPT Coils are the most efficient produced, and show a saving over any other coil of reputable make. The Concert Coils with a wavelength range of 150 to 800 metres are single layer coils wound on ebonite formers, and are being successfully used for the reception of American Broadcast in England. Coils 75 to 1500 are the Burndept patent multi-layer coils, and cover all wavelengths from about 750 to 25,000 metres. Distributed capacity reduced to a minimum.

Set of 4 Concert Coils £1 : 0 : 0K. Coil 1500 £1 : 0 : 0K.
Coils 75 to 1500 can be purchased singly. Set of 9 £4 : 10 : 0K.

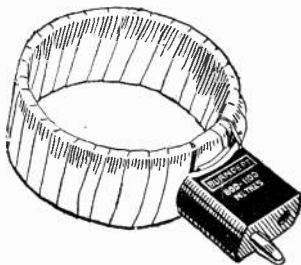

BURNDEPT Intervolve Transformer

THE Burndept Intervolve Transformer has been designed to secure maximum amplification with minimum distortion. The coils are former wound and vacuum impregnated; they are mounted on a laminated stalloy core. These Transformers will not burn out when used with anode potentials up to 150 volts, as they have been tested at a pressure of 2500 volts, winding to winding and frame, and also with a current of 10 milliamperes flowing through the windings. Minimum insulation resistance 250 megohms. Guaranteed against breakdown. No. 226. PRICE £1 : 5 : 0A.

No. 283. Mounted and Boxed, £1 : 15 : 0A.

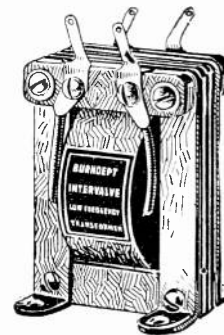

A fully Illustrated Catalogue containing much useful information and details of our apparatus will be sent post free 1/-.

All **BURNDEPT** Valve Apparatus is duly licensed under Marconi Patents for Amateur use in Great Britain.

BURNDEPT, LTD., London Office & Showrooms: 15, Bedford Street, Strand, W.C.2

Exchange Buildings, 133, New Street, BIRMINGHAM.

Aerial and Eastnor Works, BLACKHEATH, S.E.3

93 Holm, Street, GLASGOW.

Midland Bank Chambers, YEovil.

London Assurance House, Bond Place, LEEDS

67, Bridge Street, MANCHESTER.

BURNDEPT

WIRELESS APPARATUS

Laboratories and Factories :
King's Rd., St. Pancras,
LONDON.

ANODE All communications to Reg. Offices :
265, STRAND, W.C.2
Tele. Nos. : City 4887, Cen. 3722

WIRELESS AND SCIENTIFIC INSTRUMENTS LTD.
Members of the British Broadcasting Company

The Set with a BIG REPUTATION

To the People of LONDON, MANCHESTER and BIRMINGHAM,
Broadcasting in your town is now in full swing.

The Anode **POPULAR SINGLE VALVE SET** is all you require.

Price £7 : 10 : 0

(Valve Phones and Batteries Extra)

NOTE GREAT WAVELENGTH RANGE. 350 to 600 metres and 2000 to 3600 metres.
FOUR SETS OF HEADPHONES MAY BE USED ON THIS INSTRUMENT.

Satisfaction Guaranteed. Send Cash with Order. Immediate Delivery from Stock.

Manufacturers to Post Office design of Receiving Sets now in operation at "Leafield," "Cairo," "Northolt," etc.

NOW is the Time to Order. Your Final Choice. Why Not Your First?
Trade Enquiries Invited.

EBONITE

for all radio purposes

Highest Grades only made.

Sheets (polished, matt or
tinfoil surface.)

Panels cut to size.

Rod, Tubing and all types
of moulding for Wireless
Instruments.

Take advantage of
our long experience
in Ebonite manu-
facture, and secure
the best material
for your purpose.

St. Helens Cable & Rubber Co., Ltd.

WARRINGTON

London Branch : 70/71, Petty France, Westminster, S.W.1

Get All Your Wireless Needs from GAMAGES

Because you are dealing with the PIONEERS OF BETTER APPARATUS FOR AMATEURS—a Firm with too high a reputation to supply Wireless Goods below the high standard of efficiency the Amateur must have to make his experiments successful—his

hobby worth while. Gamages hold the largest stocks of first grade sets and apparatus at lowest prices in London. Pay a visit to Holborn or write for the Free Wireless Catalogue—it's worth while.

COMPARE THESE VALUES

SINGLE VALVE Broadcast Receiver IN MAHOGANY CABINET.

Complete and self-contained. Fully licensed and passed by the Postmaster-General, bearing the Registered No. 1043. The tuning coil (tapped in three places) and variable condenser, give a wavelength of 300 to 620 metres. Further stages of amplification can be added at will, and with a low frequency amplifier a loud speaker can be effectively employed. It is possible with this compact set to receive telephony and concerts over a distance of 30 to 40 miles with surprising clarity. The cabinet contains a section to hold 'phones and valve when not in use. The lid can then be placed on, keeping the set free from dust and preventing damage, etc. Price, including Royalties and complete with all accessories,

£13: 10s.

VALVE CABINET alone (including Royalties)
£4 : 15s.

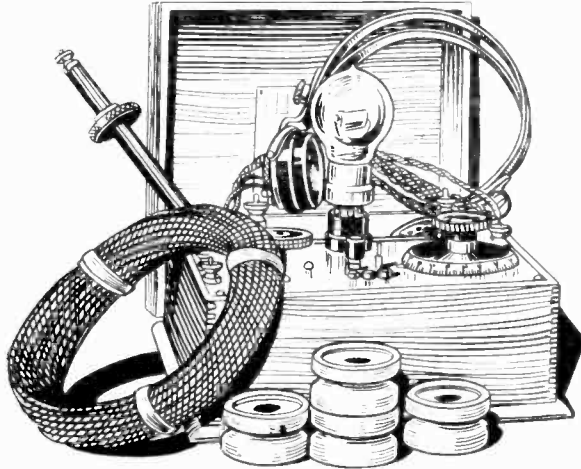

Gamages Crystal Broadcaster (No. 1)

A complete receiving outfit, comprising Tuning Coil with ratchet slider, capable of fine adjustment; Crystal Detector; High-grade 'Phones; Aerial Wires; Insulators; Aerial and Earth Terminals. The wavelength covered is approximately 180 to 950 metres. Telephony (concerts, etc.), can be received up to 20 miles and Telegraphy (Spark Signals) up to 200 miles. An ideal set for a beginner, being very simple in operation. Highly finished in every detail, and rigorously tested, this set has proved satisfactory in every way. Price Carriage paid.

70/-



Special Set of Wireless Tools

In polished Teak box. Comprising 1 set B.A. Stock Dies and Taps; 1 set of Twist Drills; 1 set of 6 Engineers Needle Files; 1 set of 3 1/2 Files; 1 Combination Drill Chuck, Tap, Wrench and Tool Holder; Lancashire Brooch Solder Iron; 2' Rule; Electricians Turnscrows; Pliers; Long Nose Pliers; Bradawl; 1 box of 70 lengths hard Brass Wire; Pattern-maker's Hammer; Pin Tong; Pin Vice; Jewellers' Turnscrow, with 3 blades; Fixed Turnscrow; and Tweezers, etc. Price complete Carriage paid.

52/6

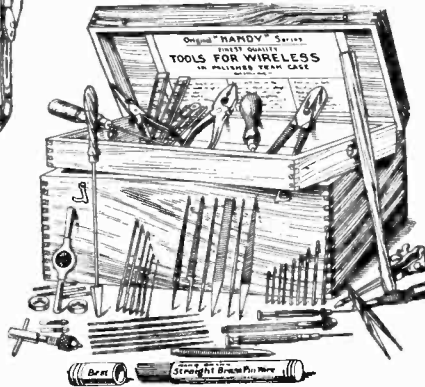

GAMAGES · HOLBORN · LONDON · E.C.1

DUTCH CONCERTS

ON A

HOME MADE

2 VALVE SET

THIS IS WHAT

CONQUEST

OFFERS YOU

IN THE JANUARY ISSUE.Price **1/- net.** Post free **1/3**

Full working details with "fool proof" diagrams and illustrations of how to make this set are given.

Granted that it's not the smartest looking set made, but it works, and works well, too.

This is not a theoretical set; it's practical; it's been tried and proved to be

AN ABSOLUTE SUCCESS

This one constructional article alone is worth more than the shilling charged for the magazine.

Get the January number which will be published on December 20th.

IT WILL PAY YOU**CONQUEST**

The Magazine of Popular Science,
12/13 Henrietta Street, London, W.C.2

NOW READY**BINDING CASES**

VOL. X.

The

**Wireless World
& Radio Review**

(INCLUDING INDEX)

Price **2/6** net.

(Post free 2/11.)

INDEX (IF PURCHASED SEPARATELY)Price **8d.** Post free.**COMPLETE BOUND VOL. X**

(April—September, 1922)

Price **25/-** net.

(Post free 26/-)

For the benefit of those of our readers who desire to have their parts bound, we shall be glad to undertake this for them upon receipt of the copies and remittance of 8/6 which includes cost of Binding Case, Index and return postage.

The WIRELESS PRESS Ld.

12-13, Henrietta St., London, W.C.2

1923
DIARIES

Let your 1923 Diary be a
Wireless one.

The Amateurs'
Diary and Notebook

Consisting of Charles Letts & Co.'s standard diary, with the addition of a section giving useful Circuits and Diagrams, List of Chief Regular Transmissions, Memoranda Pages for recording new call signals, and general data of value to Wireless Experimenters and "Listeners-in."

The Diary is encased in pig-skin grained "slip-in" covers with pockets for cards, stamps, etc.

Price **2/6** Complete. Post free **2/9**

The Wireless Press, Ltd.
12-13 Henrietta St., London, W.C.2

**SIEMENS
DRY CELLS
AND
BATTERIES**



REG. TRADE MARK

KNOWN AND USED ALL OVER
THE



Descriptive pamphlet and prices on application to
THE MANUFACTURERS:

SIEMENS BROTHERS & Co. LTD.

General Offices and Works:

WOOLWICH, LONDON, S.E.18

Telegrams—Siemens, Woolwich.

Telephone—City 6400.

And at Belfast, Birmingham, Bristol, Cardiff, Glasgow,
Leeds, Manchester, Newcastle, Sheffield, Southampton.

GREAT BARGAIN OFFER

To Readers of the "Wireless World"
For a short time only
—while the stock
lasts.

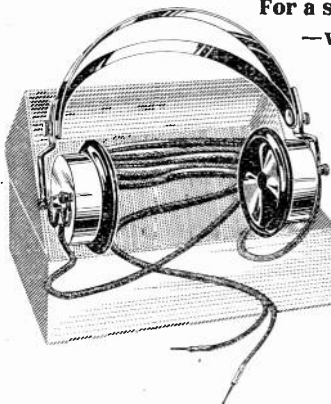

2,000
Pairs only

4,000 ohm
PHONES
(NEW)

at
17/6

PER PAIR.
Postage 9d.
extra.

Fitted headbands and cords, beautifully finished, thoroughly efficient. Each pair carefully packed in box. *Satisfaction guaranteed.*

A wonderful bargain, never before offered and cannot be repeated. Readers of the "Wireless World" are urged to take advantage of this astonishing offer immediately. All orders will be executed in strict rotation.

Broadcasting Receiving Apparatus

The "JOYPHONE" (Reg. No. 0138) Approved type.
2-Valve Set complete £15 : 0 : 0

Approved by Postmaster-General.

TERMINALS.

4 B.A. Double Solid Brass or Plated, 2/- per doz. (post. extra)
2 B.A. Single " " " 9d. " " " "

Special Offer at Reduced Prices of our

**NEW
Intervalve
Transformer**

Owing to the unexpectedly large sale of these instruments, we are enabled to reduce the price to "Wireless World" readers to—

14/- postage 9d.
extra.

Fitted with panel fixing plate and earthing wire for iron core. Fully tested. Ratio 5 : 1.

To obtain goods at these special bargain prices, please mention the "Wireless World"

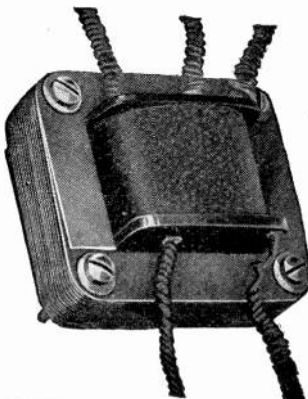

We have ENORMOUS STOCKS OF EX-W.D. WIRELESS GEAR, too numerous to mention, at absurdly low prices. Write for particulars of your requirements or, better still, call and see our enormous stocks.

All valve apparatus manufactured by us is duly licensed under Marconi Patents for amateur use in Great Britain.

J. LIPOWSKY & CO.
614, Old Ford Rd., Bow, London, E.3
Telephone—East 3345.

Near Old Ford Station, N.L.Ry.

Nos. 8 or 39 'Bus



Specification of our well-known **CONDENSERS**. Highest grade Aluminum Plates, Brass Washers machined to a limit of + or - .001" Adjustable Brass Bush at bottom, Fixed Brass Bush at top. These Condensers are built to stand **HARD** continuous usage and we **GUARANTEE THEM**.

Value in M.F.	Panel Mounting in Parts	Panel Mounting Assembled	Cabinet Mounting in Parts	Cabinet Mounting Assembled	Cabinet Mounting Assembled in Cabinet	Polished Mahogany Cabinet.
.0015 ..	23/-	25/8	24/-	26/8	33/-	6/8
.001 ..	16/9	19/8	17/9	21/-	26/-	5/8
.00075 ..	13/6	16/3	14/6	16/8	22/-	5/8
.0005 ..	10/6	13/-	11/9	13/9	18/-	4/8
.0004 ..	10/-	12/6	11/-	13/3	17/6	4/8
.0003 ..	9/-	11/6	10/-	12/-	16/-	4/-
.0002 ..	7/-	9/-	8/-	9/6	13/6	4/-
.0001 ..	6/-	8/-	7/-	8/6	12/6	4/-
Vernier ..	—	4/6	—	5/-	9/-	3/6

Fitted with Bevelled Ebonite Dial 1/9 extra.
 Special Sizes made to Order. Price list on request.
ALL SUNDRIES AND COMPONENTS IN STOCK.
ORDERS OVER 20/- CARRIAGE PAID.
TRADE ENQUIRIES SOLICITED.

THE "BROADWAY" RADIO WORKS
 DEVONSHIRE ROAD, BEXLEYHEATH, KENT.

THE AUDIOPHONE

EMPLOYING THE UNIT SYSTEM.

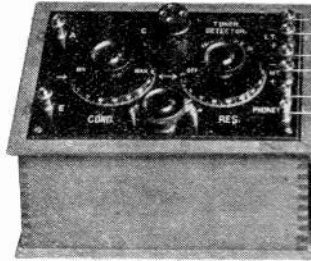

SPECIFICATION.

Highly skilled hand labour throughout. Bare, tinned internal wiring, bent on formers, and soldered at all connections, thus ensuring a noiseless circuit. Polished ebonite panel, engraved white. Polished mahogany cabinet. Wavelength range 300-550 m.

P.M.G. Reg. No. 1018.

TUNER DETECTOR.

Price as shown **£7 7s.**
 Price complete:—H.F., L.F. 'Phones, M.O. Valve, and Aerial Wire and Insulators **£12 3s.**

Prices include Marconi Royalty and commission to B.B.C.

TERMS. Cash with order, or five days' approval against full deposit.

Higher wavelengths obtained by means of plug-in coils. Fully approved by P.M.G.

IMPORTANT: Fixed Reaction is a feature of this Receiver.

Manufactured under Marconi Licence by—

J. R. WRIGHT

10, Carton Street, Baker Street, W.1

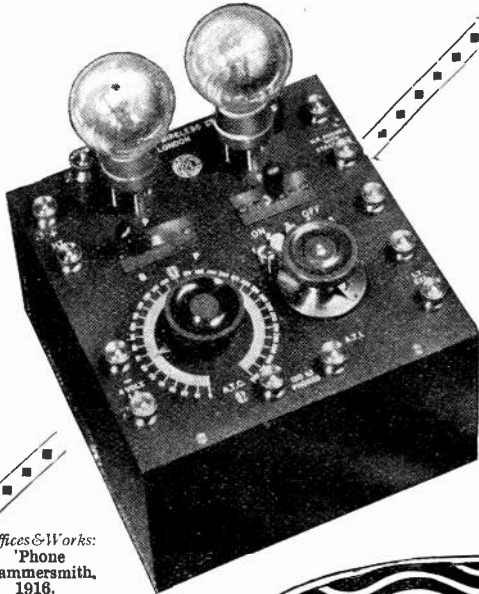

Uniformly Efficient

THE supreme excellence of TINGEY Wireless instruments under all conditions and tests is now universally appreciated. A splendid example is the 2 Valve Model which is claimed to represent the highest attainment in mechanical perfection and capacity.

Two Valve Broadcasting Receiving Set

Wavelength 300 to 2,800 metres. Complete with all accessories, including Valves, Brown's 'Phones, High Tension Battery, Accumulator, 100 ft. Aerial Wire, Insulators, lead-in tube and earthwire.

PRICE - 21 gns.

including Broadcasting Fees. Carriage paid U.K.

ALL TINGEY instruments bear the B.B.C. stamp.

All "TINGEY" Valve Apparatus is duly licensed under Marconi Patents for Amateur use in Great Britain.

Send for illustrated Catalogue containing full particulars of 1, 4 and 5 valve sets.

Offices & Showrooms :
 92, QUEEN ST.,
 HAMMERSMITH
 LONDON, W.6.

Offices & Works:
 Phone
 Hammersmith,
 1918.

Telegs.
 "Tingoidar London,"

TINGEY WIRELESS LTD.



ANNOUNCING

that the famous

**BRANDES
'MATCHED TONE'
HEADSETS**

Standard equipment of the best Radio Receivers since 1908, and which are unrivalled in sensitiveness, durability, and accuracy of construction, are now made and sold in England by

CANADIAN BRANDES LIMITED
105, Great Portland Street, London, W.1

Telephone No. : LANGHAM 1145.

Trade enquiries invited.

B
L
D

STARTLING REDUCTIONS



Aluminium Condenser Vanes, per doz.	6d.	Ebonite Condenser Dials, Engraved 0-180° and filled white with Kuob, Brass Bush and Set Screw . . .	2/6
Spacer Washer, small 3d. doz.; large 4d. doz.		Dial only	1/6
Knobs, with 2 BA Brass Inset	3d.	Valve Holders, Screwed Legs	9d.
Grid Leaks (enclosed), 2 meg.	1/6	Siemens' Halske Valves for rectifying and amplifying (tested)	7 6
Grid Condensers	1/6	Crystals (special selected), Bornite, Zincite, Galena, Silicon, Carborundum, Copper Pyrites, Graphite, Tellurium, etc.	6d.
Filament Resistances	3 6	Egg Insulators, Green	4d.
Crystal Cups with Screw Fusible Alloy, per stick Inductance Tubes, 12" x 3"	4d.	Reel Insulators, best quality	3d.
" " 12" x 4"	9d.	Hellesen 36v. batteries with tappings and Wander Plug	8 6
" " 12" x 5"	1/-	Essex 15v. H.T. Batteries Ebonite Leading In Insulators	3 -
" " 12" x 6"	1 3	Perikon Detectors on Ebonite Complete with Crystals	4/-
Sliders and Plungers	5d.	" 'Ubique.' Crystal Set Complete	15.-
Sq. Brass Rod, 12" x 1/4" x 1/4"	4d.		
Enamelled Wire, 23 gauge, lb.	2/-		
Aerial Wire, 7/25, Stranded, 100'	3/-		

DELIVERY BY RETURN GUARANTEED. Postage extra.

The ESSEX WIRELESS CO.

Office and Showrooms:
 499, GROVE GREEN RD., LEYTONSTONE, E.11
 Telephone—Wanstead 749. (1 min. from Station, G.E.R.)

1923

To all our Clients and Friends we send our heartiest Greetings for the New Year with sincere wishes that in Prosperity and Success 1923 will exceed your Brightest Expectations.

Bertram Day

BERTRAM DAY & Co. Ltd.

Wireless Advertising Specialists

9 & 10, CHARING CROSS, S.W.1

GERRARD
 8063, 8064, 8065
 MANCHESTER

ADBERTRADA
 WESTRAND, LONDON
 AND GLASGOW

E

C

ESTAB.
1896

E

L

E

C

Telephone:
MUSEUM 1055.

“XTRAUDION”
THREE ELECTRODE VALVE
 Oscillates
 Rectifies
 Amplifies
 Filament consumption 5
 amps at 4 volts;
 Anode potential 50 volts.
PRICE 15/-



Phenomenal Value new No. 30 Weston Relays. Price 20/-, not a sixth of their cost
 Operate on a current of 50 microamperes.

Write to-day for 40 page Radio Catalogue mailed post free 4d.

Head Office—10, FITZROY SQUARE, LONDON, W.1

Showroom: 303, EUSTON RD., N.W.1

TONS

of EBONITE SHEET in Stock for immediate delivery in quantities suitable for all classes of WIRELESS WORK.

SHEETS - RODS TUBES - PANELS

TUBES and ROTORS for Variometers.
MOULDED KNOBS (various patterns),
COMBINED DIALS AND KNOBS,
3", 3½" and 4" diameters.
Do. for Fil. Res. and Vario-Couplers.
AERIAL INSULATORS.

Wholesale only.

AMERICAN HARD RUBBER
COMPANY (Britain) LIMITED,
13a, Fore Street, London, E.C.
Teleg. "Eboniseth, Ave. London." Phone: Central 12754.

WIRELESS

NEW AND EX-GOVERNMENT APPARATUS

H. T. Battery Box, large type, polished mahogany, complete with plugs and sockets	5/6
Switch Arms, with bush for panel	1/-
Filament Rheostats for panel mounting complete with pointer	2/6
1, 2 and 3 Mf. Condensers	1/9
Microphones with Replaceable Insets	1/9
120 w. Receivers (Single)	4/-
Fixed Condensers	2/-
Variable Condensers, 00-1, 18/6; 000-5, 15/6 in case.	
Walnut Cases for Accumulators, with hinged lid, and carrying strap	5/-
Mk. III and Mk. III* Crystals, mixed	doz. 3/6
Ditto,	gross 28/-
Special stranded wire coils for broadcasting, per pair	2/9
Best Type Silk Wire Transformers, telephone, 15-Intervalve	20/-
4,000 Double Headphones, with coils	22/-
C.M. III 3-Valve Amplifiers	£4 10s.
Moving Coil Ampmeter, 0-10 amps	15/6
Telephone Magnets, 60 ohms	pair 1/-
Ebonite Leading-in Tube, with Terminals	1/6
Boxes, suitable for Accumulators, H.T., etc., complete with lid, Fuses and Switch	5/6
Alli. Pulley Wheels for Aerials	1/-
Other New and Ex-Government Apparatus in Stock.	

C. S. SWAN,
191, Bishopsgate, E.C.2
(Under Brandon, Tailors), and 65, Windsor Road, Leyton, E.10.
Phone, Bishopsgate, 1156.
ALL GOODS GUARANTEED.

TOMLINSON LONDON, LIMITED.

*Demonstrations
Daily.*

3, FINCHLEY RD., ST. JOHN'S WOOD, N.W.8
Hampstead 1844

*Demonstrations
Daily.*

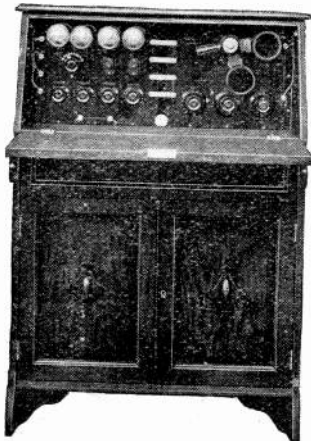

THE ARISTOCRAT OF RECEIVING SETS

A splendidly designed Four-Valve Self-contained unit, fitted with a three-circuit tuner, and contained in a beautifully finished Jacobean Cabinet. Complete with Loud Speaker, High Tension Batteries, Accumulators, Valves and Coils.

INCLUSIVE PRICE 62 GNS.

This really beautiful instrument is the result of weeks of patient study on the part of one of our foremost Wireless Engineers, and it has been worked out with painstaking thoroughness down to the minutest detail.

STALLOY TRANSFORMER LAMINATIONS
 SOLE MANUFACTURERS AND SUPPLIERS
JOSEPH SANKEY & SONS LTD
 WORKS: BILSTON, STAFFS. London Office: 168 RECENT ST. W.I.
 TELEPHONE RECEIVER DIAPHRAGMS

THE WIRELESS WORLD AND RADIO REVIEW

THE OFFICIAL ORGAN OF THE RADIO SOCIETY OF GREAT BRITAIN
A MAGAZINE DEVOTED TO WIRELESS TELEGRAPHY AND TELEPHONY

CONTENTS

The Manchester Broadcasting Station	- - - - -	421
Exhibition of 10-kW. Vacuum Tubes	- - - - -	424
Chemical Rectifiers for Plate Voltage Supply. By E. H. Robinson	- - - - -	425
Electrons, Electric Waves, and Wireless Telephony. By Dr. J. A. Fleming, F.R.S.	- - - - -	429

Contents continued on next page.

RADIO : Supplies :

- A Super Phone. 4000 ohms. 25/-
- Our Special Xmas British Phone 20/-
- Flush Type Ammeters to 15 Amps. 10/-
- Aerial 7/22 high grade Wire, 150' 6/-
- Lightning Arresters ... 5/-



BRITISH MADE
20s. post free
4000 ohms.

- Variometers for Armstrong Circuit 18/-
- Variometers wound for Broadcasting 17/-
- Variometers not wound 7/-
- Ducon, which needs no Aerial 10/-
- Grid Leaks with Condenser 4/-

COME TO OUR SHOWROOMS AND HEAR A DEMONSTRATION.

We are one of the Oldest Wireless firms and our engineers have years of experience which is at YOUR disposal.

234, HIGH HOLBORN (2nd Floor), LONDON, W.C.1.

Phone: HOLBORN 2188

EFFICIENCY is the keynote of our productions
The BEST you can get is a "**BROADCO**" Set
THE BROADCAST WIRELESS CO., LTD., 2, Tower Royal, Cannon Street, E.C.4.
Send for descriptive Catalogue and Terms.

CONTENTS *(Continued)*

Civil Airship Wireless in 1922. By Lieut. Duncan Sinclair	- - - - -	436
Wireless Club Reports	- - - - -	443
Notes	- - - - -	446
Calendar of Current Events	- - - - -	446
Correspondence	- - - - -	447
The Problem of Aerial Insulation	- - - - -	448
Questions and Answers	- - - - -	449
Share Market Report	- - - - -	454

THE WIRELESS WORLD AND RADIO REVIEW is published weekly on Saturdays.

All correspondence relating to contributions should be addressed to THE EDITOR, THE WIRELESS WORLD AND RADIO REVIEW, 12-13, Henrietta Street, Strand, London, W.C.2.

No responsibility can be taken for MSS. or photographs sent without stamps to defray cost of return postage.

Editorial and Publishing Offices : 12-13, Henrietta Street, Strand, London, W.C.2.

Telegraphic Address : "Radionic, Rand, London." Telephone No. : Gerrard 2807.

Advertisement Managers, Bertram Day & Co., Ltd., 9 and 10, Charing Cross, S.W.1.

Telephone No. : Gerrard 8063 and 8064

SUBSCRIPTION RATES.

28s. per annum, post free. Single Copies 6d., or post free 7d.

Registered at the G.P.O. for transmission by Magazine Post to Canada and Newfoundland.



HERE IS A GOOD TRANSFORMER.

Intended for the serious experimenter, no other Intervalve Transformer has such an expensive coil. Statically and Magnetically Screened, it is mounted in brass case, finished dull black. Very easy to fix, with plenty of clearance space. May be used side by side with absolute silence and absence of interaction. With this transformer used in multiples your three valves will give the results of four valves. Price is 30/-. Order direct and, if possible, give name of usual wireless dealer. TRADERS desiring to see samples of LISSEN PRODUCTS manufactured throughout in our own works, should apply on trade heading.

Dealers desiring to sell Lissen Products should write to us.

LISSEN COMPANY, 35, Oxford Street, London, W.1

"LET'S LISSEN-IN."

Works---HAMMERSMITH.

To the
Discriminating
Experimenter.

A New Filament Resistance

Holders of experimental licences who make their own apparatus are naturally anxious to obtain the highest possible efficiency in every component part. To meet the requirements of the discriminating experimenter the Marconi Scientific Instrument Company, Ltd., are now selling a line of high-grade component parts of the same quality as those used in their own justly famed "Units." As an example, the Marconi filament rheostat illustrated herewith possesses a number of features which make it unique.

Firstly, the resistance wire is heavy enough to carry current for three valves, if necessary, without overheating. The wire itself is wound on a grooved former. Contact is made by a heavy copper spiral which, when rotated by the knurled ebonite knob, moves smoothly from one end of the coil to the other. There are no "jumpy" places, no jolts and jars, and the movement throughout is as smooth as that of a good variable condenser. Contact between the former and the spiral is maintained by the spring shown.

This resistance is supplied ready for panel mounting with high-grade ebonite knob and pointer, together with fixing screws. Mounting is effected by drilling a central hole $\frac{3}{8}$ ths diameter, and three clearance holes for 4 B.A. metal screws. The brass support is supplied already threaded for these screws.

The price—12/6—is very reasonable compared with that charged for the ordinary type of rheostat. A potentiometer would on exactly the same principle is sold for 15/-, the resistance being 300 ohms.

*The Marconi Scientific Instrument Co. Ltd.
The House for the Discriminating Experimenter.*

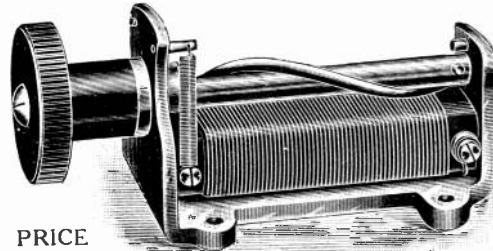

PRICE
12/6

Special Holders for V24 and QX Type Valves

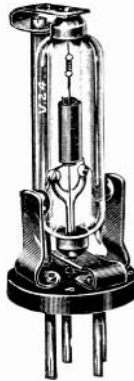

Type D.
PRICE
4/-

Many experimenters are anxious to try the V24 and QX valves in their own receivers. These valves are of tubular form, and are mounted in a manner different from that of the ordinary "four-pin" types. Both valves oscillate very readily on low anode voltages, and the former is very popular for separate oscillators. Both QX and V24 valves have a very low self capacity, and are therefore useful in short wave reception. The Marconi Scientific Instrument Company, Ltd., is now marketing adaptors which will enable these valves to be used in any four-pin socket. They are particularly recommended to those who have constructed heterodynes for either short or long wave work, as they enable very low anode voltages to be used.

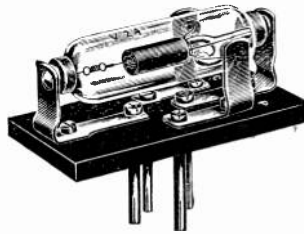

Type E. PRICE 3/6

Are you making wireless gifts for Christmas? Call at our Dean Street Show-rooms, and see the full range of components and complete sets.

The Marconi Scientific Instrument Co. Ltd.

Telegrams : Themasinco, Westcent. 40 Dean Street, Soho, W.1

Telephone : Gerrard 7745.

The Battery with 40 Years' manufacturing experience behind it.

The finest quality materials and experienced workmanship go to make this a battery to be absolutely relied upon to give the steady high voltage so necessary to insure the best results in Wireless Reception.

PYRAMID H.T. BATTERY.

- 15 Volt .. 3/6
 - 30 Volt (with Variable Plug connection) .. 7/-
- (Post Orders delivered within 24 hours.)

We also manufacture complete wireless sets and all component parts, of which the following is a much abbreviated list.

BROADCAST RECEIVING SET.

Price, complete with British made headphones, aerial, and everything ready for fixing .. **£5**
(Plus 7/6 Broadcasting Fee.)

Low Frequency Amplifiers for use in conjunction with this set having special transformers. Price .. **£5**

Two of these amplifiers are capable of working a loud-speaker with excellent results within a distance of 20 miles from London.

Filament Resistances ..	3 9
" Ideal " Valve Accumulators in case, 4 volt 50 amp. (Carriage, 2/-)	25-
6 Volt. 50 amp. (Carriage, 3/-)	35-
Variable Condensers (of various capacities) from ..	6 -
Fixed Condensers ..	2 6
Three-Coil Holder, complete Unit for use with Standard Coils ..	20 -



ILLUSTRATED LISTS FREE ON REQUEST, OR VISIT OUR SHOWROOMS.

WATES BROS., 13-14, GREAT QUEEN STREET, KINGSWAY, LONDON, W.C.2

J. BURNS, LTD.

Wangye Works,
Chadwell Heath, Essex.

We are actual manufacturers and can offer special advantages to the trade—send us your enquiries.

CONDENSERS.	Retail price
.001 mfd.	13/6 ea.
.0005 "	10/- ea.
.0003 "	9/- ea.
.00005 "	4/6 ea.
Filament Resistances ..	2/- ea.
Terminals with high base ..	1/6 doz.
Contact Studs, with nuts ..	9d. doz.
Sliders, with springs and studs ..	9d. ea.
Ebonite Panels, cut to order ..	3/6 lb.
Ebonite Coil Holders ..	12/6 ea.
Ebonite Knobs	4/- doz.

Single Valve Panels

fitted with Variable Condenser, Filament Resistance, Grid Leak and fixed Condenser, Engraved Panel and Rosewood finished Box, ready for use

£4

Vulcanised Fibre and Ebonite Sheets, Rods & Tubes from stock.

EBONITE AND VULCANITE

TUBES—RODS—SHEETS

LARGE STOCKS

BRITANNIA RUBBER AND KAMPTULICON CO., LTD.

7, NEWGATE ST., LONDON, E.C.1

Telephone
2168 Central

Telegrams:
Britannia, London

THE WIRELESS WORLD AND RADIO REVIEW

THE OFFICIAL ORGAN OF THE RADIO SOCIETY OF GT. BRITAIN

No. 176 [No. 13.
VOL. XI.] DECEMBER 30TH, 1922.

WEEKLY

The Manchester Broadcasting Station

A DESCRIPTION OF THE INSTALLATION.

THE station is situated in the Research Department of the Works of the Metropolitan-Vickers Co., Ltd., Trafford Park, Manchester. The company is technically very closely associated with the pioneers of broadcasting, the Westinghouse E. and M. Company of America, and claim to have at their disposal the whole of the experience and technical knowledge of that company.

The broadcasting station is at present being operated each evening from 6 p.m. until 10 p.m., and it is anticipated that transmissions will shortly commence on Sundays. Great care is exercised in the selection of suitable programmes and the choice of artistes. It is found that artistes with a good reputation for ordinary

stage and concert work are not necessarily successful from the point of view of broadcasting, and it is anticipated the demand will be met sooner or later with the provision of training schools where the peculiar technique necessary may be acquired.

The power for the radio transmitting set is supplied by a small generator in the works power-house at 440 volts, 50 cycles, 3 phase, and this is employed to drive a triple set consisting of an induction motor, high tension direct-current generator and exciter (see Fig. 1). The high tension generator is rated at 2.5 kW.

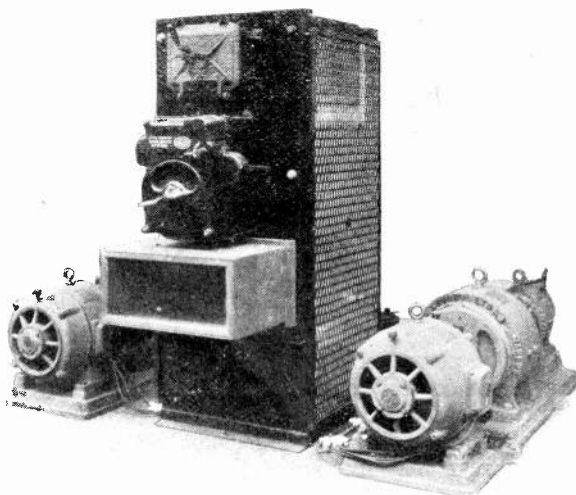

Fig. 1. The power plant of 2 ZY.

at 5,000 volts, and runs at 1,500 R.P.M. The full load current is therefore 0.5 amperes. The exciter is a small direct-current generator,

and supplies the field of the high tension generator through a potentiometer type field regulator. This enables stable adjustments to be obtained even down to very low voltages which are occasionally required for test and experimental purposes.

Two of these sets are installed, and a complete change-over of drive and supply can be effected in emergency by throwing over a single switch from one side to the other. Suitable filter circuits are provided at the high tension generator to receive the commutator ripple.

The transmitter panel was installed by the Radio Communication Co. of London, and employs four Mullard 0-500 valves and one Mullard 0-150 valve (Fig. 2). The high tension D.C. supply is applied at 5,000 volts directly to the anodes of the valves, and suitable protective gear is provided to protect the generating set against short circuits. A trip-switch can be seen above and to the right of the operator's table.

The lower operating handles in the set control the grid excitation and tuning. The second row control the filament heating circuit.

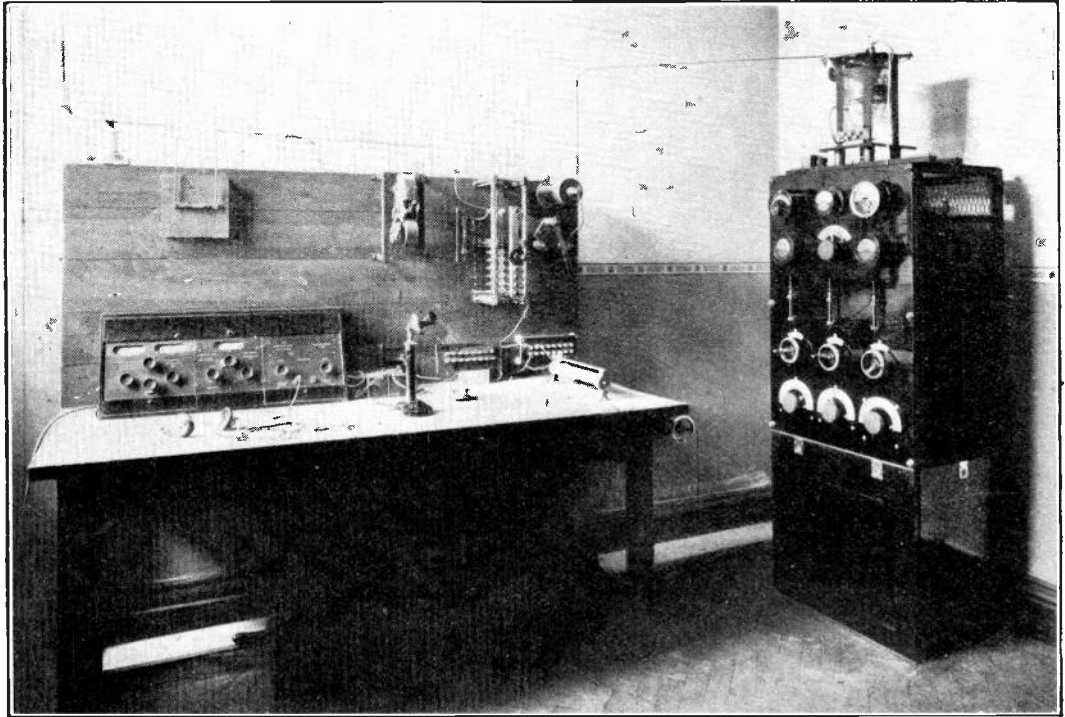

Fig. 2. The transmitting panel and listening-in arrangement.

Referring to Fig. 1, the two power sets are located one on each side of the control panel. The generator is the centre machine, and the induction motor, which is rated at $5\frac{1}{2}$ H.P., is the first machine. The rear machine is the exciter.

The throw-over switch to transfer the main and starting gear from one set to the other is the lower switch on the panel. In the centre is the starting and overload gear, and the upper switch is the high tension switch for connecting the supply to the transmitter.

Suitable ammeters and voltmeters are mounted on the upper portion of the panel. The aerial lead-in may be seen fastened to an insulator on the top of the operating table. A fuse is included in the circuit. The A.T.I. is the coil situated at the top of the panel, and the grid excitation coil may be seen secured to the top of the A.T.I. The coupling is varied by rotating the grid coil through pulleys and string. A special listening station is provided at Hale, seven miles away from Trafford Park, so that the character of the

modulation can be checked. The filaments of the transmitting valves are heated from a 30-volt battery of accumulators.

The studio (Fig. 3) is accommodated in a spacious room adjoining the transmitting room. The walls are draped with suitable hangings, and the floor has been carpeted to avoid the resonance and echo encountered from the floor and walls of ordinary rooms. The equipment comprises a Steinway grand piano with a Welte player attachment, a new Edison gramophone of the latest diamond-disc type, and an Aeolian Vocalion Graduola

special microphone is used. A distribution board is used to switch on the microphone required, and the sounds picked up are given a preliminary amplification in the studio, and further amplification is given in the transmitting room before the amplified currents are impressed on the aerial. The distribution switch and three-valve amplifier are seen secured to the wall of the studio.

The aerial used is of the cage type, and is suspended between the top of the water-tower and the highest point of the main works building. The lead-in is taken from the

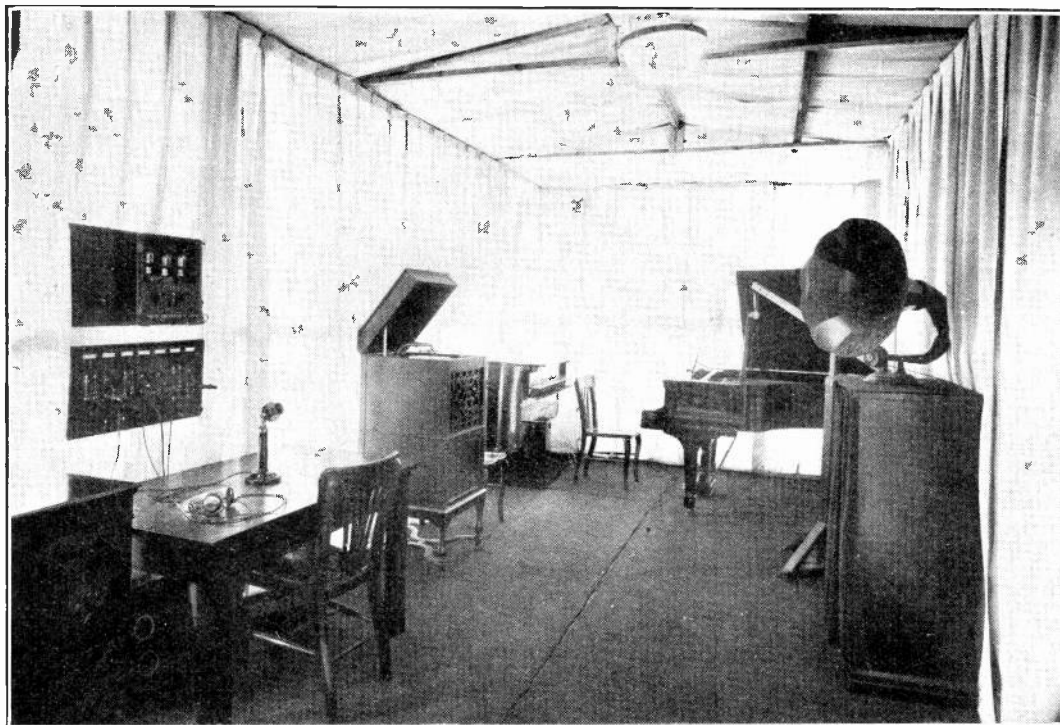

Fig. 3. The studio of 2 ZY.

cabinet gramophone. The studio is connected with the transmitting room by multicore cables which may be used for microphone or other control circuits, these latter being run in separate cable to avoid inductive interference. The music and speech from the studio is picked up by microphone or other suitable apparatus supported on convenient stands and placed in the correct position relative to the source of sound. The ordinary Post Office solid-back type of microphone is used for all purposes with the exception of transmissions from the piano, for which a

centre of the main aerial and drops into one of the research laboratories. Each cage has six wires supported by suitable loops, the average height being 160 ft. An earth connection is used.

The station has worked since its inception on 800 watts, and an aerial current of 5 amperes is obtained. It is hoped to increase the power almost immediately to 1.5 kW., the full power for which the station is licensed.

Because of the experimental nature of the station, further technical details are not yet available for publication.

Exhibition of 10-kW. Vacuum Tubes.

Before the meeting of the Institution of Electrical Engineers last week, an exhibition of 10-kW. Vacuum Tubes was given by the President. The vacuum tubes shown are, of course, recent developments of the original thermionic rectifying valve, made by Dr. Fleming.

The large 10-kW. valves are used for radio transmission, and are of two types, the rectifier (2 electrodes) and the oscillator or amplifier (3 electrodes). A special feature of these valves is the water-cooled anode, consisting of a copper tube, which is fused to the glass bulb by means of a special copper-glass seal. This joint is

CENTRE: *Filament Grid and Anode of 10-kW. Transmitting Valve before assembly.*

BELOW: *A complete 10-kW. Transmitting Valve.*

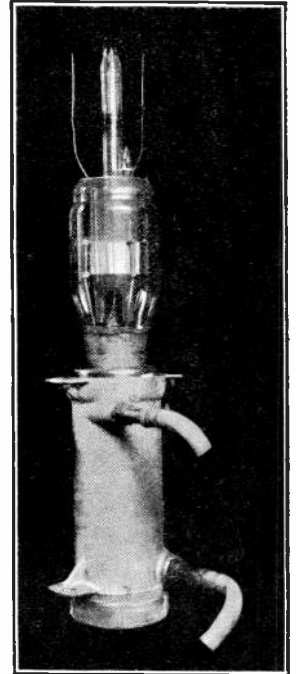
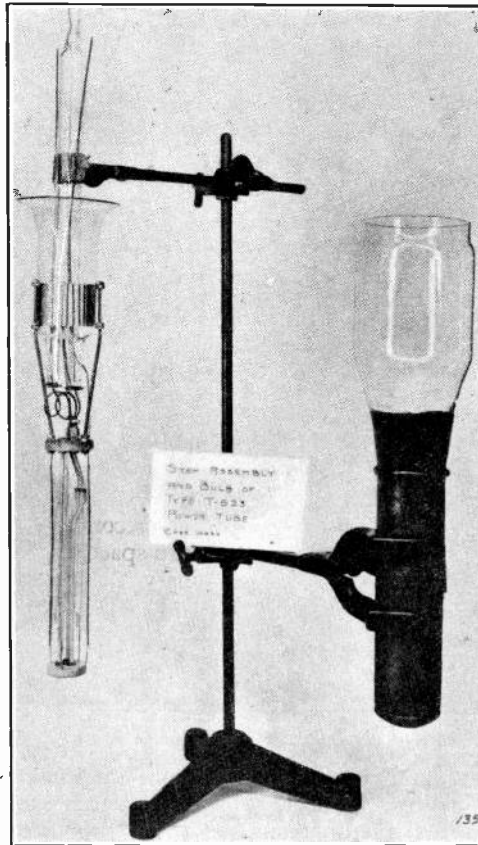
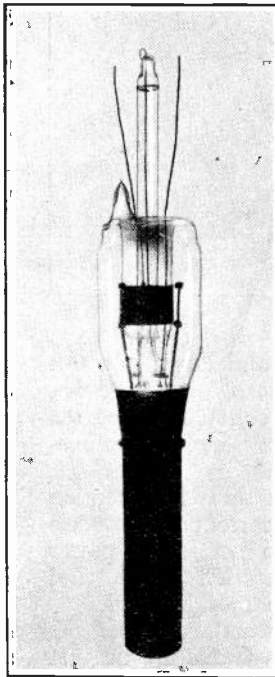

ABOVE: *Valve inserted in water circulated cooling jacket.*

gas tight, and is unaffected by the heating and cooling occurring both during manufacture and operation. When in service the tube is mounted so that the anode is surrounded by a metal jacket through which cooling water circulates.

A further exhibit showed the detailed assembly of the filament, grid and anode, the nature of the copper-glass joint upon the latter being readily seen.

The following are the characteristics of the 10-kW. tube:—Normal filament current, 24.5 amperes; normal filament voltage, 32; normal plate voltage, 10,000; power taken by valve (including losses in valve), 15 kW.; and output power delivered, 10 kW.

Chemical Rectifiers for Plate Voltage Supply.

By E. H. ROBINSON (2 VW).

UNDOUBTEDLY the greatest problem that faces the amateur when he starts using thermionic valves for reception or transmission is that of obtaining a cheap but reliable source of high tension current. Where electric lighting mains are laid on it is cheaper to derive one's H.T. from this source than to buy dry batteries, especially when more than one hundred volts is required. The use of D.C. mains has been dealt with in a recent issue of the *Wireless World and Radio Review*,* and as many municipal lighting supplies are alternating current I shall confine

TRANSFORMER.

Almost any type will do as long as the primary is suited to the voltage of the A.C. mains and the secondary gives an effective voltage a little higher than the required high tension voltage. As both periodicity and voltage vary considerably in different localities it is impossible to give specific values for the windings of the transformer. The writer's transformer, which

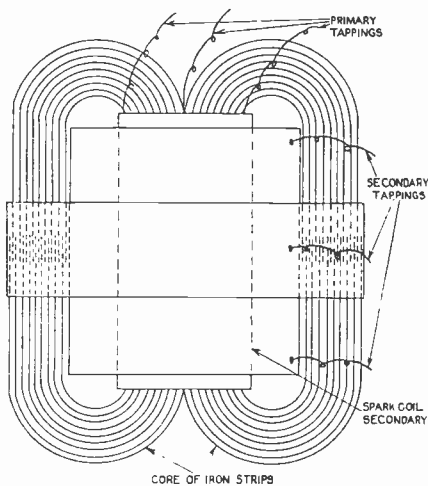

Fig. 1.

my remarks to the use of the latter. In the writer's opinion the man who has access to A.C. is much better off than the man who has D.C. at 200 volts, because A.C. can be transformed up or down without serious loss to any desired voltage. With D.C., on the other hand, one cannot obtain more than the supply voltage, and to obtain less it is necessary to insert wasteful resistances or potential dividers.

The device which I am about to describe is cheap to make and will give a smooth current of 50-100 milliamperes at voltages from 500 downwards, suitable for transmission or for receiving amplifiers.

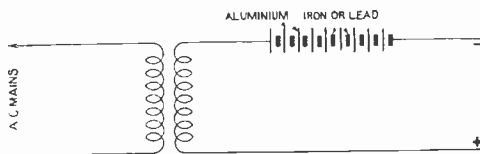

Fig. 2.

works off 40 volts at 90 cycles, is made out of an old $\frac{3}{4}$ -in. spark coil. The original primary was removed and another inserted consisting of 1 lb. of 20 gauge D.C.C. copper wire wound neatly on a core made up of 30 flat strips, $\frac{3}{8}$ in. by 14 ins., cut from ordinary tinfoil (tinned iron). After insertion of the primary the strips were bent over, as shown in Fig. 1, to form a closed magnetic circuit. As a matter of fact it was found necessary to unwind some of the secondary from the inside in order to make a space large enough to accommodate the primary. This was easy enough as the secondary had been wound in layers separated by waxed paper and not in sections. There are tappings on both primary and secondary so

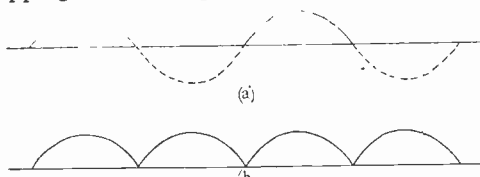

Fig. 3.

that a large range of voltages is obtained from 1,000 volts downwards. The transformer is fairly efficient considering its simplicity and cheapness.

RECTIFIER.

The action of the rectifier depends on the well-known fact that an electrolytic cell containing an aluminium electrode and an iron

* June 17th, 1922, p. 343.

one dipping into a saturated solution of ammonium phosphate will allow current to pass from iron to aluminium but not in the

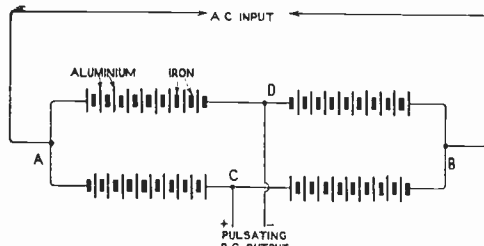

Fig. 4.

reverse direction, provided that the alternating E.M.F. applied to the cell does not exceed about 80 volts. If therefore we wish to suppress one half of the cycle of A.C. at say 500 volts, we must use a unit of about six such cells in series. Such an arrangement is shown in Fig. 2, but the resulting current would consist of unidirectional pulses, as shown in Fig. 3a by the thick-lined humps, with inactive periods between them. Half-cycle rectification is somewhat difficult to render smooth by means of chokes and condensers; fortunately however we can, by a slight elaboration of the rectifier,

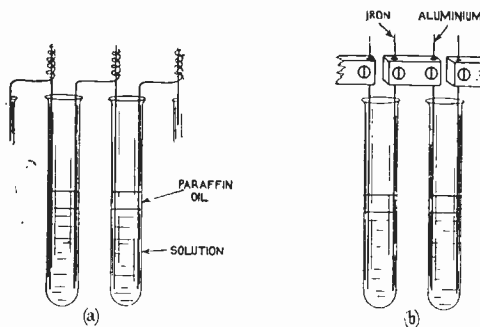

Fig. 5.

utilise the suppressed portion indicated by the dotted lines in Fig. 3a and obtain in the output circuit a pulsating unidirectional current of the nature indicated in Fig. 3b. The arrangement of the cells is shown in Fig. 4. There are four units of several cells each, and it will be seen that if an alternating electromotive force is applied at A and B the output at points C and D will have a constant polarity, C always being positive and D negative.

As the currents required in valve work are very small, usually only a few milliamps, the rectifier cells may be quite small. The writer's own rectifier is made up of 24 test-

tubes 5 ins. long by $\frac{5}{8}$ ins. diameter, each about half-filled with a saturated solution of ammonium phosphate. The electrodes are simply 16 gauge aluminium wire and 16 gauge galvanised iron wire respectively, dipping about one inch below the surface of the electrolyte, this giving ample electrode surface for ordinary purposes. The experimenter is advised however to use 16 gauge tin or lead fuse wire in place of the iron wire as the latter, although perfectly satisfactory while it lasts, becomes eaten away after continued use. Connection between electrodes in successive cells has been made as shown in Fig. 5a by

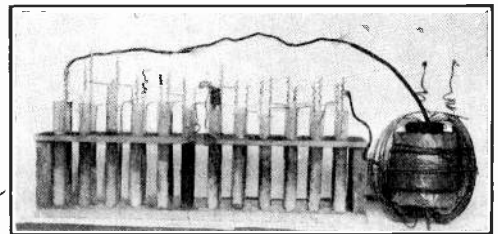

Fig. 6.

bending the iron wire into the shape indicated, inserting one end of the aluminium wire into the spiral portion and hammering the joint on a flat surface so that the iron wire nips the aluminium firmly. In view of the fact that the electrodes need renewing occasionally, the arrangement in Fig. 5b would be more satisfactory; here the short brass connectors with set-screws will allow any electrode to be replaced in a moment. The whole rectifier is mounted in a wooden test-tube rack, such as may be seen in any chemical laboratory, and occupies an overall space 3 ins. \times 14 ins. base by 7 ins. high. Fig. 6 shows the general arrangement. This rectifier is designed to give four or five hundred volts for transmission,

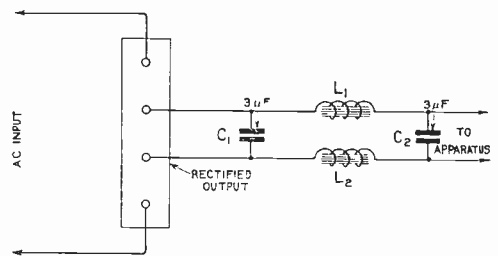

Fig. 7.

but for receiving purposes where voltages of only about 30-90 are required fewer cells may

be used ; four groups of 3 cells each will be more than sufficient.

SMOOTHING OUT A.C. RIPPLE.

In order to render the pulsating D.C. obtained from the rectifier suitable for ordinary purposes it is necessary to convert it into a continuous and uniform flow of current, otherwise there would be a terrific hum in the phones in the case of a receiver, or in the emitted carrier-wave in the case of a transmitter. This is effected by passing the current into a 3-mfd. condenser C_1 (Fig. 7), thence through chokes L_1 and L_2 of two or three henries inductance each, and into another 3-mfd. condenser C_2 . From C_2 leads are taken to the valve circuits. L_1 and L_2 may be the secondaries of two small induction coils. The writer is using the secondaries of two old Ford ignition coils which were picked up cheap, the usual core consisting of a bundle of soft iron wires being retained. With such a smoothing device it is practically impossible to get A.C. ripple in the output, even with half-cycle rectification. The condensers C_1

and use ammonium phosphate. Ammonium molybdate is stated to be the best electrolyte,

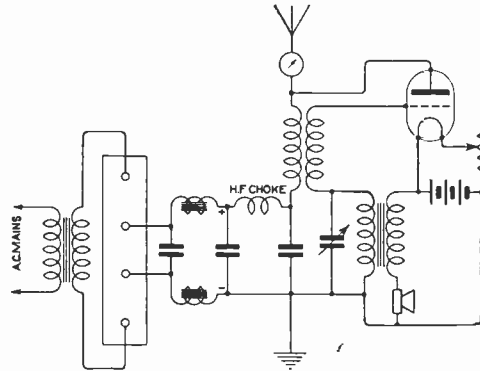

Fig. 9.

but as its cost is prohibitive the writer has not tried it.

A good plan is to float half an inch of paraffin oil on top of the electrolyte. This prevents "creeping" of the salt in solution, retards evaporation, improves insulation and lessens corrosion of the aluminium just where it enters the solution.

In connection with the use of Mansbridge condensers I ought to add a word of warning, particularly to those who intend to use several hundred volts across them. Always light your valve filaments before switching on input in to H.T. supply ; if the H.T. is switched on with the filaments out an excessive potential may build up across the condenser and break down the dielectric. Mansbridge condensers will stand 500 volts, but not much more, and if higher voltages are contemplated, then each 3-mfd. condenser will have to be replaced by two 6-mfd. ones in series. Breakdowns are indicated by a crackling noise in the condenser.

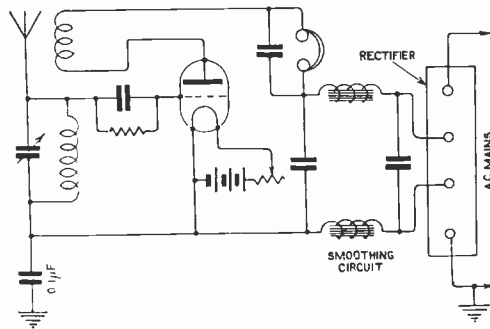

Fig. 8.

and C_2 may be of the Mansbridge rolled type which can be bought very cheaply. The construction of a smoothing unit was described in the article referred to earlier.

MISCELLANEOUS DETAILS.

Various details should be attended to in order to get the best results. First, the electrolyte should be a saturated solution of pure ammonium phosphate. The "commercial" product is cheaper and will work, though less efficiently. A copious sludge may form after a few days' use, but the presence of this does not seem to matter. Sodium bicarbonate and borax are often recommended as substitutes for ammonium phosphate, but though very cheap they are in the writer's experience inferior, and it is better to pay twice as much

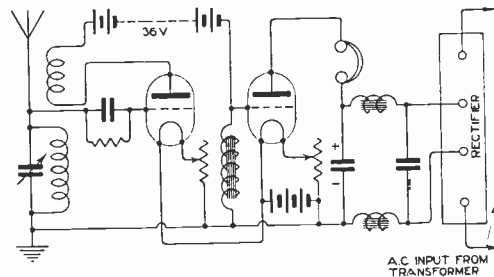

Fig. 10.

It may occur to the reader that where voltages not exceeding 100 or so are required the transformer could be dispensed with and

the rectifier worked direct off the mains; but here a difficulty arises as one side of the mains is always earthed. If, as is usual, a part of the valve circuit is connected directly to earth, half the rectifier becomes short-circuited and rendered inoperative. This trouble however may be overcome by inserting a fixed condenser in the earth lead of the set as shown in Fig. 8. A transformer (not auto-coupled) is preferable, as it is safer and gives greater flexibility of adjustment of voltage.

RESULTS OBTAINED.

The rectifier described above has been used both for receiving and transmitting with very satisfactory results. The telephony transmitter circuit is shown in Fig. 9. When the filament is lit with an accumulator the carrier wave is absolutely free from ripple and several other stations report that the C.W. is as pure as if dry cells were being used for H.T. The transmitter is capable of putting over 0.3 amps. into a 30-ft. (double) aerial on a wavelength of 400 metres. If the filament is lit off 6 volts A.C. a slight ripple is introduced.

When receiving I sometimes use my power valve (an A.T. 40) as a note magnifier as shown in Fig. 10. An ordinary 36-volt battery is used on the detecting valve (an R) and 300-400 volts from the rectifier and the amplifier. The form of coupling between the two valves seems to give less distortion of received telephony than transformer coupling. The choke L may be a pair of high resistance phones or the secondary of an ignition coil. Absolutely no A.C. hum is detectable in the telephones and

the magnification of signals which are fairly strong in the first place is enormous.

I claim the following advantages of the chemical over the thermionic rectifier for A.C. rectification:—

- (1) Much cheaper to install (mine cost me only a few shillings).
- (2) Cheaper to run as there are no filaments to light.
- (3) Less fragile.
- (4) Much less resistance to currents in the right direction, consequently less loss in potential than with a thermionic valve.

A freshly made up set of cells should work without requiring attention for a month or two, according to the duty it has to perform.

N.B.—I do not wish to be responsible for the untimely electrocution of any innocent reader, so I will add a warning about H.T. transformers. Although an H.T. transformer such as I have described does not give such high maximum potentials as, say, a 2-in. spark coil, it is capable of delivering through the human body much larger currents and must be treated with respect accordingly. The H.T. side must be well insulated and nothing connected to it should be touched without first making sure that the input current is switched off. It is advisable to switch off the current feed to the transformer primary, prior to the valve filaments, first to avoid breakdown of the Mansbridge condensers, and secondly to ensure that the condensers are discharged before touching the apparatus. Also make sure that the primary windings are suited to the mains off which they are to work.

ELEMENTARY INSTRUCTIONAL LECTURE.

An experimental Lecture dealing with the Principles of Radiotelephony, and primarily intended for Associates of the Radio Society of Great Britain, will be given by G. G. Blake, M.I.E.E., A.Inst.P., at the Institution of Electrical Engineers on January 12th, at 6.30 p.m. Tickets will be sent to Associates. All interested are invited, and tickets can be obtained by sending a stamped and addressed envelope to Mr. Leslie McMichael, Hon. Secretary, The Radio Society of Great Britain, 32, Quex Road, West Hampstead, N.W.6.

Electrons, Electric Waves, and Wireless Telephony—XIII.

By Dr. J. A. FLEMING, F.R.S.

The articles appearing under the above title are a reproduction with some additions of the Christmas Lectures on Electric Waves and Wireless Telephony given by Dr. J. A. Fleming, F.R.S., at the Royal Institution, London, in December and January, 1921-1922. The Wireless Press, Ltd., has been able to secure the serial rights of publication, and any subsequent re-publication. The articles are therefore copyright, and rights of publication and reproduction are strictly reserved.

4.—PRODUCTION AND DETECTION OF ELECTRIC WAVES OF GREAT WAVELENGTH.

Our next step must be to explain the manner in which electric waves of much longer wavelength than those employed in the above experiments can be created and detected. Especially is it necessary to describe the method of generating the type of electric wave employed in wireless telephony.

It will be convenient to begin with a description and explanation of an instrument called a thermionic valve, because this is used not only to create but to detect these electric waves of great wavelength.

It has been mentioned already in speaking of the free electrons in conducting materials that these atoms of electricity are in constant irregular motion in the inter-atomic spaces. Part at any rate of the sensible heat contained in any substance which gives it what we call its temperature, is due to the energy of motion of these free electrons.

According to a certain theory called the theory of equipartition of energy, these free electrons should have the same average kinetic energy as gas atoms would have at the same temperature. We have seen that the root mean square (R.M.S.) value of the velocity of molecules of oxygen gas is nearly 461 metres per second, and since the atom of oxygen is 16 times heavier than the atom of hydrogen, the R.M.S. velocity of hydrogen molecules is $\sqrt{16} \times 461 = 1844$ metres per second. But a negative electron has a mass of about $1/1,700$ th of that of a hydrogen atom. Hence the R.M.S. velocity of the free electrons in a

conductor should be

$\sqrt{1700} \times 1844 = 41 \times 1844 = 75604$ metres per second, or nearly 47 miles per second.

If the temperature of the conductor is raised this electronic velocity will be increased, being nearly proportional to the square root of the absolute temperature; that is, the temperature reckoned from -273° centigrade. If then the temperature is very high, the velocity of some of the free electrons may become so great that those near the surface of the material are flung off from it.

This, indeed, is what happens when a wire, say, of tungsten is heated to a bright incandescence in a high vacuum, as in the case of the filament of an incandescent electric lamp. It must be remembered, however, that every electron which escapes leaves behind it a chemical atom deprived of an electron, and therefore having a positive electric charge of equal amount. Hence unless we supply from some source electrons equal to those that escape, the metal, if insulated, would soon acquire such a high positive potential as to hold back more electrons from escaping. This emission of electrons, due to high temperature, is called *thermionic emission*.

In order that it may take place continuously, we have to surround the incandescent metal with a metal enclosure and to connect the positive terminal of a battery to this sheath or plate, and the negative pole to the hot filament (see Fig. 65).

The arrangement then that is necessary is to construct an ordinary high vacuum incandescent electric lamp, having a straight or loop filament (*F*), preferably made of drawn tungsten wire, because that material has a very

high melting point and will bear heating to $2,000^{\circ}\text{C}$. or $2,500^{\circ}\text{C}$. without risk of fusion (see Fig. 61).

Around this filament but not touching it, is a metal cylinder (*P*), made of sheet nickel, which is fastened to a platinum wire (*A*), sealed airtight through the glass bulb. With such an appliance it is very easy to show that an incandescent metal filament in a vacuum is giving off negative electricity by the following experiment (see Fig. 65.).

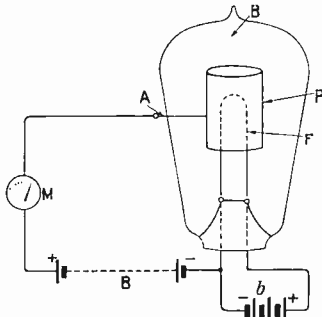

Fig. 65. A Fleming Oscillation Valve.

Provide a gold leaf electroscope, consisting of a pair of gold leaf slips contained in a glass bell jar. Connect the terminal of this with the metal cylinder of a valve. Give to the gold leaves and metal cylinder a charge of negative electricity by means of an ebonite rod, rubbed with flannel. If the filament of the valve is not incandescent the gold leaves should remain diverged, that is, the system should retain an electric charge of negative electrons.

If then we make the filament incandescent by passing an electric current through it, we shall find that the negative charge is still retained by the cylinder and gold leaves.

If, however, we give to them a charge of positive electricity by means of a warm glass rod rubbed with silk, the filament being cold or not incandescent, we shall find that the system still retains that charge provided the insulation is good. The moment that the filament is made incandescent by passing a current through it, the gold leaves of the electroscope collapse, showing that a charge of positive electricity is instantly removed from the cylinder. This can only be due to the emission of negative electrons from the incandescent filament. It is convenient to make the filament of such a length that it is rendered incandescent by the current from a storage battery of two to six cells or, say, 4 to 12 volts.

If then we connect the positive pole of another separate voltaic battery to the terminal of the metal cylinder, technically termed the plate, and the negative pole to the negative terminal of the filament, and if we insert in that circuit an instrument called a milliammeter, for detecting and measuring electric currents, we find a current, that is a stream of electrons moving, inside the bulb from the hot filament to the metal cylinder. This is called the *thermionic current*.

Since the stream can only flow when the cylinder is positively electrified and the filament negatively electrified, because the filament can only emit negative electrons, the device enables us to permit electrons to move in a circuit only in one direction. Hence it was named by the author in 1904, who so used it for the first time, an *oscillation valve*, and it is now commonly called a *Thermionic valve*.

The great use of it proved to be to convert high frequency alternating currents of electricity into unidirectional or direct currents. If in place of the battery we connect the plate of the valve with the filament through a circuit outside the valve which contains some source of alternating electromotive force or high frequency oscillations, then it will be evident that when the electromotive force is in such a direction as to make the cylinder or plate positive, an electron current will flow from the filament, but when the plate is negative it will keep the electrons from coming out of the filament. Therefore the electron current is always in one direction through this external circuit or plate circuit as it is called. The high frequency alternating current is then said to be *rectified* by the valve, when used as follows:—

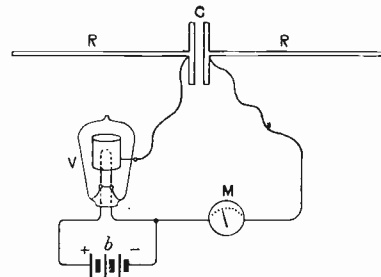

Fig. 66. RR. Rod resonator.
C. Condenser.
V. Oscillation valve.
M. Galvanometer or Milliammeter.

Let there be two metal rods placed in line with each other in a region through which electric waves are passing, and let these rods be placed with their lengths parallel to the direction of the electric force in the incident waves and let their total overall length be adjusted so that it is about $2\frac{1}{4}$ times the wavelength. In other words, let the natural frequency of oscillation of the whole rod be adjusted to be equal to the wave frequency (see Fig. 66). Then let these be inserted between the rods, a circuit comprising an oscillation valve as above described, and also a sensitive galvanometer, which is an instrument for detecting a direct electric current. If then an electric wave falls on the receiving rods it will create electric oscillations in them, but the thermionic valve will only allow the currents in one direction to pass and to affect the galvanometer.

If the electric waves are produced by spark discharges in a transmitter, as explained in a previous section, then these waves and the oscillations they produce in the receiving rods come in little groups with intervals of silence. These are called *damped trains of oscillations*. When rectified by a Fleming valve they are then converted into little gushes of electricity, all in one direction, which come at intervals of time equal to the intervals between the spark discharges.

We can then employ as the detecting instrument a telephone receiver, made as explained in the next section.

A telephone does not permit the passage of a high frequency current through it, but it is caused to emit sound if an interrupted direct current is sent through it, having the frequency of the interruptions between, say, 100 and 10,000. Accordingly, on listening to the telephone receiver when it is joined in series with the plate circuit of a thermionic valve, in which a series of damped electric oscillations are being created, we hear a musical sound as long as the groups of oscillations continue. The frequency of this sound is the same as the frequency of the groups of oscillations, that is, of the sparks creating them.

An improvement on the original single cylinder or two-electrode valve was effected by the interposition of another cylinder of metal gauze, or a spiral of metal wire between the filament and the cylinder of solid metal. This gauze or spiral cylinder is technically termed a *grid*, and a thermionic valve with a

cylinder (plate) and grid is called a three-electrode valve (see Fig. 67).

This triple-electrode valve is remarkable for the astonishing number of ways in which it may be used to detect as well as create electric oscillations. We shall first briefly describe its use as a detector of feeble damped electric oscillations, which come in groups or trains.

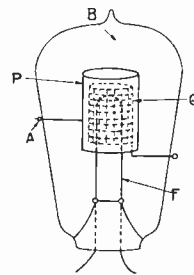

Fig. 67. A three-electrode Thermionic Valve.

For this purpose we connect the negative terminal of a voltaic battery *B*, say, of 40 or 50 cells to one terminal of the filament of a valve, which we shall assume has a filament rendered incandescent by a small separate battery *b* of three cells (see Fig. 68). The latter is called the filament heating battery,

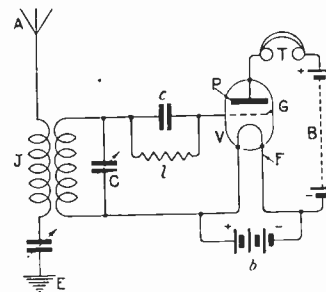

Fig. 68. One method of using a Thermionic Valve to detect damped electric oscillations set up in an aerial *A*.

and the former the plate battery. This last has its positive terminal connected to the cylinder or plate of the valve and the circuits of a receiving telephone receiver *T* are included in this circuit; the terminals of the telephone are usually also connected to the plates of a small condenser.

In the next place the grid is connected to one terminal of a small condenser *c*, called the grid condenser, and this condenser has its terminals also connected by a very high

resistance l , called the grid leak, which often consists of a piece of ebonite on which has been rubbed some plumbago or so-called black lead.

The second terminal of the condenser is connected through one coil of an induction coil with the filament of the valve, the other circuit of this induction coil being included in the circuit in which oscillations are generated by the electric waves to be detected. On the other hand the filament of the valve and one terminal of the grid condenser can be connected to the receiving aerial wire as shown in Fig. 64.

The operation then is as follows. When electric waves fall on the receiving or aerial wire they create in it oscillations, and these in turn charge the receiving condenser in one direction or the opposite, and this causes the grid to be charged with electricity either positive or negative. Again the battery in the plate circuit is causing a stream of electrons to issue from the filament, and these make their way to the plate by passing through the interstices or holes in the grid.

If the grid is negatively electrified, which means if there are negative electrons on it, then, owing to the mutual repulsion of electrons of like kind, these prevent the electrons from the filament from passing through the grid to reach the plate. If, however, the grid becomes positively electrified by the oscillations from the aerial, then the negative electrons from the filament neutralise that positive charge. Hence the effect of the oscillations in the receiving wires is to cause the plate-current or flow of electrons from the filament to be reduced, and therefore to check the current through the telephone. It is then necessary to provide a means by which the negative charge on the grid can be continually removed. This is achieved by the grid leak, which is a very high resistance of several million ohms put across the terminals of the grid condenser. This leak brings the grid back to a neutral condition between the arrival of each group of waves. If then these waves are produced by a spark transmitter of the Hertzian type, the impact of each group on the receiving wire causes a sudden decrease in the thermionic current flowing through the telephone, and this, as explained in the next section, causes the telephone to emit a sharp brief sound. If then the groups of waves continue to arrive, these sounds run together into a musical note of the same frequency as the spark of the discharger.

By making these sparks endure for various periods of time, short or longer in accordance with a certain code of alphabetic signals, the auditor listening in at the receiving telephone will hear sounds of corresponding duration and can spell out the letters received. In this manner wireless telegraphy on the spark system is accomplished.

Before we can discuss other methods of employing this triple electrode valve for detecting feeble electric oscillations it will be necessary to explain briefly the nature of its *characteristic curve*.

We insert in the external plate circuit of a thermionic valve a battery with negative pole connected to the filament and an instrument called a milliammeter for measuring small electric currents by the deflection of an indicating needle over a divided scale. These currents are conveniently measured in terms of a unit called a milliampere, which is one thousandth part of an ampere, or about one-tenth of the current through an ordinary 200-volt incandescent lamp.

We then make arrangements for giving to the grid a positive or negative potential by means of a battery of varying number of cells.

Let us begin with the grid in a neutral or un electrified condition, viz., at zero potential.

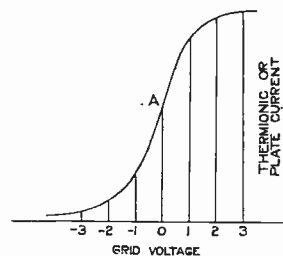

Fig. 69. A characteristic curve of a Three-electrode Thermionic Valve.

The thermionic current or flow of electrons from the filament has then a certain strength, called the normal strength, when reckoned in milliamperes. This current of negative electrons flows from the filament, through the grid to the plate or cylinder of the valve, and then back through the external circuit and the milliammeters to the filament. We can represent this current by the length of a vertical line OA drawn perpendicularly to a horizontal line on which we mark off lengths proportional to the voltage of the grid (see Fig. 69). If then we make the grid slightly

negative, say by 1, 2, 3, volts, etc., we shall find that the plate or thermionic current gradually decreases, and this may be represented by lines of decreasing height drawn at equal intervals of distance to the left of the central normal line. If we make the grid positive by 1, 2, 3 volts respectively, we find that the plate current increases, but not indefinitely. It reaches soon a maximum value which cannot be exceeded. The plate current is then said to be *saturated*. If we join the tops of the vertical lines denoting the plate currents we obtain a curve called the *plate-grid characteristic curve* of the valve.

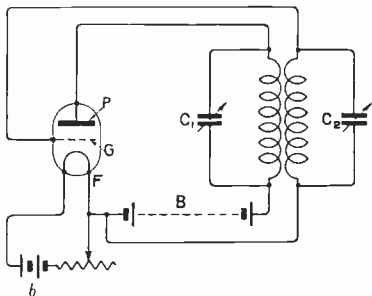

Fig. 70. Method of using a Thermionic Valve to create undamped electric oscillations. P. Plate of valve. G. Grid. F. Filament. B. Plate battery. b. Filament battery.

We see, therefore, that if we give the grid a certain positive voltage corresponding to the point at which the curve just begins to bend over, and if we superimpose on this steady voltage an alternating high frequency voltage due to an oscillation, the plate current cannot be much increased when the latter voltage is positive, but it is decreased when the alternating voltage becomes negative.

Hence the superposition of an alternating voltage on the grid then always decreases the plate current and causes a telephone in that circuit to emit a sound which is a musical or continuous sound if the oscillations take place in intermittent groups.

The above methods of using the three-electrode valve as a detector apply only to that class of electric waves in which the waves arrive in little groups or trains with intervals of silence between the groups; in other words, to the reception of trains of damped electric waves.

On the other hand, in the great bulk of wireless telegraphy and entirely in wireless telephony, we make use of *continuous waves*

(C.W.), which continue without interruption except in so far as they are deliberately interrupted or varied in amplitude to make the signals or speech sounds.

We have then to explain how these continuous waves are detected, but must preface this explanation by a description of the manner in which this three-electrode valve can be used to generate electric oscillations, which of late years had become of enormous importance.

It has been explained that if the grid potential varies from positive to negative by removing from or adding to it excess electrons, the plate current or stream of electrons from the filament will also vary, increasing when the grid is positive and decreasing when it is negative.

Hence if we cause the grid to alternate in potential it will make the plate current also fluctuate in such fashion as to be equivalent to the superposition of an alternating current on a direct current.

If we insert in the plate circuit the primary coil of an induction coil, then the terminals of its secondary circuit will provide an alternating voltage which exactly imitates in wave from the alternating potential of the grid, but can be made to have much greater amplitude.

A little thought will make it evident that if we couple back the terminals of the secondary circuit of this induction respectively to the grid and the filament in the right direction, we can cause variations in the plate current to give the grid the proper alternating voltage to sustain those variations in the plate current, so that the apparatus continues to operate to produce high frequency continuous oscillations in the plate circuit.

We have it in our power to control the frequency of these oscillations by putting condensers C_1 , C_2 , of suitable capacity across the terminals of the primary and secondary circuits of the induction coil, these circuits being tuned to the same frequency (see Fig. 70).

We are able therefore to use the valve as a generator of undamped oscillations and it has the property of creating electric oscillations, the wave form of which is exactly a simple periodic curve like the sound wave form of a tuning fork or open organ pipe gently blown. Moreover, we can harness together a number of these generator valves so as to employ a battery of them to create very large oscillatory currents of any required frequency and simple or pure wave form.

Generator valves are now made for this purpose, which have glass or silica bulbs about the size of a football, and 50 or 60 of these valves can be arranged on panels to create very large high frequency currents.

The illustration Fig. 71 shows such a large valve panel as is used in the great Marconi Wireless Telegraph station near Carnarvon, on the flank of Snowdon, for world-wide wireless telegraphy.

Another discovery of great practical value in connection with this subject was that if the grid and the plate circuit are coupled together inductively, as above described, but if the primary and secondary circuits in the plate and grid circuits respectively are placed so far apart that they are just, but not quite, on the point of generating self-sustained oscillations, the system becomes very sensitive to the effect of any additional electric impulses produced by incident electric waves. The valve is put into a condition in which it is just on the point of self-oscillation and the effect of the feeblest waves of the frequency for which its circuits are tuned will then

be to create oscillations as long as the waves are arriving. This is called *regenerative coupling*.

We shall discuss its special application in connection with wireless telephony in a later section. Meanwhile it is important to notice that the thermionic valve has an exceedingly valuable use as an *amplifier* of oscillations of high or low frequency.

We have pointed out that any variations in the electric potential of the grid are accompanied by corresponding variations in the plate current.

Suppose we insert in the plate circuit one coil of a transformer consisting of two insulated wires, one superimposed on the other,

the two wires being wound on one bobbin or tube. In addition, we insert in the plate circuit a battery B with its positive pole connected to the plate and its negative pole to the filament (see Fig. 72).

If now we apply to the grid a feeble alternating electromotive force, this will make the grid alternately positive and negative in potential. This will, as above explained, cause the plate current to fluctuate, and this current passing through the primary coil of the transformer T_2 will create a secondary electromotive force in the adjacent coil which can be made by suitable proportioning of the circuits to

have the same frequency, but much greater amplitude than the electromotive force (E.M.F.) applied to the grid. It may in fact have an amplitude of 5 or 10 times as great. Thus if the E.M.F. applied to the grid varies from +1 volt to -1 volt, and has therefore an R.M.S. value of about 0.707 volt, the E.M.F. on the secondary terminals of the plate transformer may have an R.M.S. value of 5 or 10 times greater.

The thermionic valve is then said to amplify voltage

5 or 10 times.

It is then obvious that we can apply this amplified E.M.F. to cause fluctuations in the potential of the grid of a second valve similarly equipped with a transformer in its plate circuit, and so amplify a second stage again, say 5 or 10 times. Likewise a third valve may be used, and the result is a magnification of potential by three valves, which is, say, $10 \times 10 \times 10$ that of a single valve (see Fig. 73).

This arrangement of three valves coupled by transformers is called a *three-stage amplifier*. There is hardly any limit to the degree of amplification obtainable in this manner by a number of valves in series.

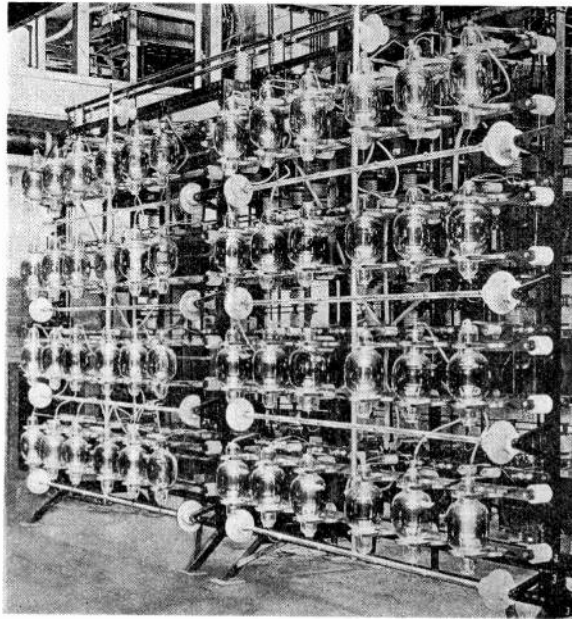

Fig. 71. Valve Transmitting Panel at Marconi Station near Carnarvon.

We can not only amplify the high frequency oscillations called *radio-amplification*, but we can amplify the rectified groups of damped oscillations which have a low frequency, and this is called *audio-amplification*.

The great achievements of modern wireless telegraphy, such as the transmission of radio messages to the antipodes and their detection at distances of 10,000 or 12,000 miles, are altogether and entirely due to the invention of the thermionic valve and to the power it has given us of amplifying to any extent extraordinarily feeble electric oscillations produced in aerial receiving wires by electric waves. Before concluding this section a brief reference must be made to the use of *crystal rectifiers* as a means of detecting feeble electric oscillations.

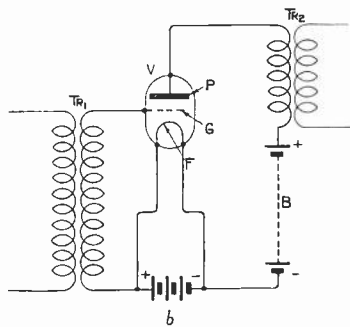

Fig. 72. A valve amplifier circuit with transformer couplings.

It has been found that certain crystals possess the power of conducting electricity better in one direction than in the opposite; that is to say, in certain directions through the crystal there is an unsymmetrical conductivity. This is particularly marked, as first shown by General Dunwoody in the United States, in crystals of carborundum. This material is a highly crystalline compound of carbon and silicon, chemically called a carbide of silicon, and made in an electric furnace by heating to a very high temperature a mixture of powdered coke and sand. Certain of these crystals of carborundum, if mounted between metal clips or supports, are found to offer less resistance in one direction than in the opposite to an electric current. Hence such a crystal, when inserted in a circuit in which electric oscillations are produced, rectifies them or converts them into a direct current just as does the two-electrode or Fleming

thermionic valve. Groups of electric oscillations can thus be rectified into intermittent gushes of electricity in one direction and thus affect a telephone receiver.

We are not able to say exactly at the present time what is the reason for this curious lopsided electric conductivity in certain crystals, but it must depend upon an asymmetry of structure. The same property is possessed by a native sulphide of molybdenum called molybdenite, as found by Professor G. W. Pierce.

Also the contact point of many pairs of crystals or minerals has the same property.

If we place in contact a piece of zincite which is a natural oxide of zinc, and a piece of chalcopyrite, otherwise called copper pyrites, which is a sulphide of copper and iron, it is found that certain contact places have a rectifying power upon electric oscillations.

Again the contact point of a bit of plumbago (black lead pencil) and galena or sulphide of lead has a similar rectifying power. These crystals or contacts can therefore be used in series with a telephone receiver to rectify or convert into direct currents groups of electric oscillations. These then become audible as sounds in a telephone receiver, which are either continuous sounds cut up into Morse code signals in wireless telegraphy, or speech sounds as explained further on in wireless telephony.

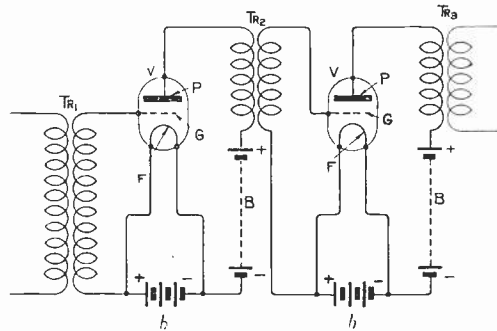

Fig. 73. Arrangement of two Thermionic valves coupled in series by induction coils to amplify electric oscillations.

In the common crystal receiving sets now being sold for broadcasting wireless telegraphy, the crystal is a specially treated piece of galena, and against it is pressed a flexible copper wire called a "cat whisker."

(To be continued)

Civil Airship Wireless in 1921.*

By Lieut. DUNCAN SINCLAIR.

IT is my proposal to discuss in a simple manner certain of the experimental flights carried out by the airships R.33 and R.36 during last year, the nature of the wireless work performed upon these flights and some of the results derived therefrom. There is hardly one of you here present who will not perhaps remember the frequent passage of these two colossal aircraft over the Metropolis at various times of the day and night during that spring and summer, and I feel I shall not be straying far from the path of truth by saying that several of your members spent sleepless but somewhat enjoyable nights listening to us. Of those inhabitants of certain districts unconcerned with the magic charms of wireless, or the mysteries of aerial navigation by methods of D.F., I almost prefer to remain silent. To them our advent meant nothing more than a midnight display of fireworks, no doubt strongly reminiscent of those war days when other airships were their visitors. Doubtless with our navigation lights, our searchlights, and our rockets we interested them in the earlier visits, but later our nocturnal flights aroused but little sympathy. As I say, they knew not the redeeming feature of wireless. The only man who to my certain knowledge cared either for our goings or our comings throughout the programme, and who, I suppose, was not a wireless man, was a policeman on duty in Trafalgar Square. I saw him with binoculars one or two fine nights when we came over, always near the same lamp. But perhaps he considered us just mere night birds after all.

Airships, as far as the Fighting Services were concerned, were crowded out in the latter part of 1920, owing to lack of funds, and plans were shortly afterwards set on foot to determine their utility from the commercial standpoint. The large airship station at Pulham St. Mary, Norfolk, to which I referred in my previous paper before this Society last year, was re-commissioned with a Civil staff, and in November special W/T operators were picked for duty at Pulham and in the air. The winter months were spent in effecting the necessary alterations to the existing ground station, in installing radiotelephonic apparatus, in carrying out the major portion of the work on the new D.F. station, and in preparing the sets for the ships.

Careful plans were being laid with a view to running the ships to Malta and possibly on to Egypt, and a considerable amount of work was performed in erecting the "mooring-mast," a novel idea, to the design of Major Scott of trans-Atlantic fame, for mooring out and landing this type of aircraft which was later to prove so eminently satisfactory.

March found the preparations for the commencement of serious experimental flights complete. From now onward the work of the wireless section can be said to be divided in two directions. There was firstly the question of furnishing the flying personnel on either ships with the necessary

communication facilities to the ground, and with D.F. navigation aids. Secondly there was the work of determining, by actual experiment, the factors of communication which would govern the operation of an airship service upon a commercial basis; the limitations particular to the different classes of wireless signalling, the safe working ranges by day and night, and even peculiarities appearing during flight. All were important questions.

Five airships were actually in commission during the year 1921, R.33, R.34, R.36, R.38 and R.80. The untimely end of R.34 will no doubt be remembered, though perhaps not so well as the awful disaster which culminated in the destruction of R.38 over the Humber, with the loss of so many gallant and valuable lives, lives which could ill

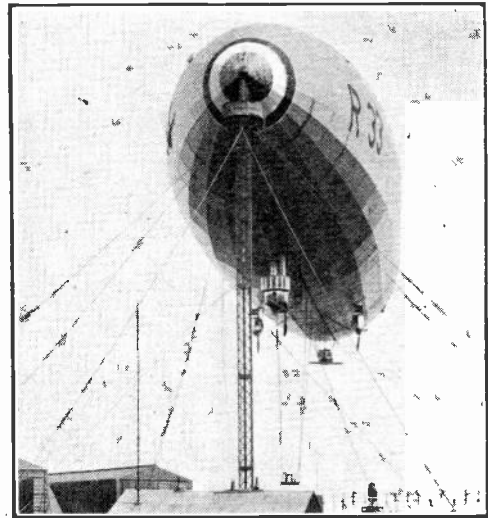

R.33 riding at the mast with the special D.F. platform slung.

be spared at a time when airships needed every conceivable assistance to prevent them from being abandoned altogether as a type of aircraft. To all intents and purposes the men who died so nobly that day represented the cream of British airship initiative and enterprise, and their loss weighed heavily in the final shelving of the lighter-than-air craft. It is a tragic thought.

The ships with which we are concerned at present are R.33 and R.36 (or, to give them their civil designations, G-FAAG and G-FAAF respectively), and, bearing in mind that the flying taking place from Pulham was of an experimental nature, let us consider briefly first of all the more important flights which were made.

(1) **R.33 (G-FAAG).** March 17th-18th (night flight).

Ship left mast at 11 p.m. in very rough weather. There was a wind of some 30 knots blowing, and it was raining heavily. The object was to test the lighting arrangements for night flying at Croydon,

* A paper read before the Radio Society of Great Britain on Wednesday, December 20th, 1922.

for which place a course was shaped. R/T communication was established with Pulham and then with Croydon. Progress was very slow owing to the head wind, and bearings given frequently by Croydon enabled the ship to keep on her course. The light at Croydon was eventually seen at 0545 from some 30 miles away at a height of 1,000 feet. After reporting this fact by R/T, the ship turned and made for home, reaching there in under two hours. This time, compared with seven hours on the downward trip, will give some idea of the weather conditions.

(II) R.33. April 29th-30th (night flight).

This flight was made for the same purpose, viz., survey of lights at Croydon, Lympne and St. Inglevert, and was a much more satisfactory trip. The route was from Pulham to St. Inglevert, back to a little way off Dover, and then up the North Sea to Southwold and in to Pulham. R/T communication was used with Pulham, Croydon and Lympne, and maintained throughout the flight. A few gramophone records were transmitted by Pulham during the flight, and the *Evening News*, in reporting this fact, unconsciously gave a very faithful forecast of the present broadcasting scheme. This music was perfectly received in the ship whilst over Gris Nez. The night was exceptionally fine, and D.F. bearings were checked by the navigator with satisfactory results.

(III) R.33. May 31st-June 1st (Derby Traffic Control).

As will doubtless be remembered by listeners-in on these two days, the combination of airship and

not the slightest delay or trouble was experienced. In fact, it proved a very satisfactory day's work for all concerned.

(IV) R.33. July 5th and 6th.

This flight was a complete survey of the air routes. The route followed was from Pulham, *via* Croydon, Lympne, St. Inglevert, Abbeville to Paris, thence *via* St. Quentin, Cambrai, Valenciennes and Mons to Brussels, and on to Antwerp,

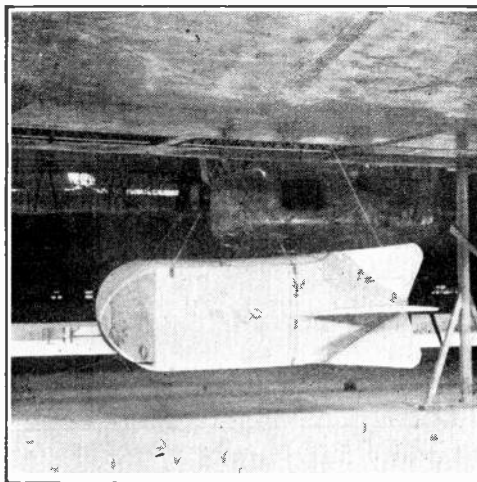

The D.F. gondola.

Ghent and Ostend, and across the North Sea to Pulham. R/T communication was established with Croydon, Lympne, St. Inglevert, Le Bourget, Brussels and Pulham, and the ship remained in W/T communication with Pulham and Air Ministry during whole flight. D.F. check bearings were taken as usual and passed to ship by Pulham and Croydon.

(V) R.33. July 2nd.

A further successful traffic control flight in connection with the R.A.F. Pageant at Hendon.

(VI) R.36.

The first important flight of this ship after leaving dock, where minor repairs had been effected, was some eight hundred miles *via* Croydon, Lympne, N.W. coast of France, down Channel to Land's End, across to the Bristol Channel and home *via* Bath. R/T communication was maintained almost throughout except when the ship was over Cornwall and then W/T was used. On this flight D.F. was entirely responsible for bringing the ship home. When some 50 miles S.W. of Pulham, the ship veered from her course to such an extent that she became uncertain of her position. It was a very dark night, and more or less overcast, so a D.F. course was requested and given by Pulham. Within two hours of flying on courses given by Pulham, the ship was seen approaching the station from the S.E. The first thing seen from the ship were the red lights at the wireless mast-heads.

(VII) R.36. June 14th.

This flight was for traffic control purposes at Ascot, and the police, having benefited by the Derby Day experience, there was not quite so much actual traffic work. As, however, some thirty news-

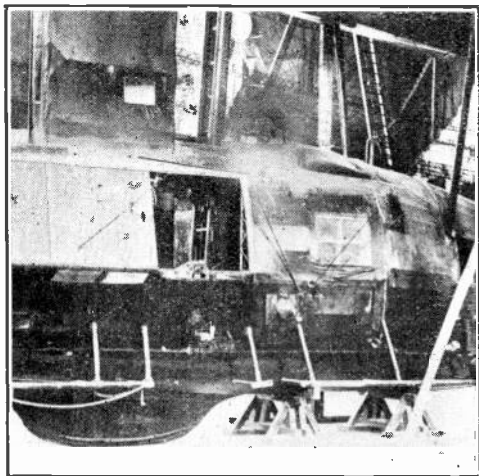

The wireless car of L71, the ex-German airship, showing the main aerial insulator.

wireless telephony proved an enormous success for traffic control work. The slightest stoppage could be immediately seen on any road from the ship, and the quickness with which the information was given to the controlling authority by R/T always prevented a slight stoppage from developing into a very serious block. The flight of May 31st was a practice for the following day—Derby Day. Upon this day the ship was in constant R/T and W/T communication for 13 hours, dealing with some 1,190 words of traffic control messages, and

paper correspondents were carried on this trip, the wireless installation was kept extremely busy with press messages.

Of these flights I shall touch upon numbers IV and VI as being the most suitable examples for detailed consideration. They were carried out in each case during the light and dark periods of the twenty-four hours over many conditions of country ; over both land and water, and during changing states of weather. In the former instance, more-

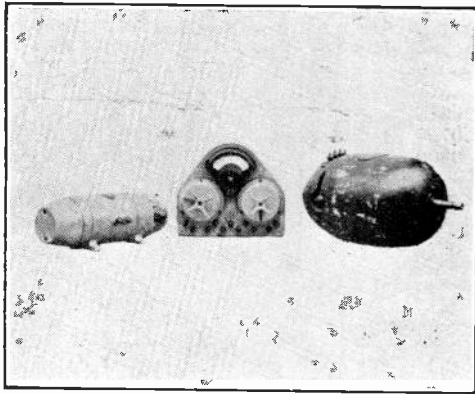

R/T Generators and Switchboard R33.

over, we are dealing with R.33, and in the latter with R.36. The area covered during the two flights comprises the whole of the Southern coast of England and a large proportion of the coasts of Northern France and Belgium, together with a not inconsiderable amount of territory, so that the tests to which the D.F. service were submitted were quite severe ones.

In order to gain a clearer conception of the nature of these trials it may be as well first of all to consider some of the main points underlying D.F. work. The system used throughout the airship programme was of the Bellini-Tosi type. As is probably well known, this system depends in its action upon the varying effect of the oncoming wave front upon two vertically placed triangular loop aerials situated at right angles to one another. Each loop is divided at the mid point of the base of the triangles, and the leads are taken to the opposite ends of small fixed coils also placed at right angles to each other, and in the same planes as their respective loops. A third coil, known as the search coil, is placed within these two, and is capable of rotation through 360° . The local electromagnetic field produced by the received signal gives rise to the usual oscillatory currents in both the fixed coils, which latter set up two local magnetic fields having a resultant. This resultant is dependent for its direction upon the direction of the azimuth of the transmitting station, or, in other words, upon the direction of the great circle running through both stations.

When the rotating coil windings are perpendicular to the resultant field the maximum effect is produced in them, and any detecting device connected to the coil will at this point register stronger signals than in any other position.

A pointer suitably attached will indicate a direction on either side of the coil in which the

transmitting station lies. In its simplest form such a piece of apparatus does not show which side of the receiving station the transmitter is located. At 90° either side of these "maxima," as they are known, it is obvious that there will be points at which the receiving signal will be at its weakest strength. These are called the "minima."

It is comparatively easier to judge, while rotating the coil, the points at which the signals are weakest than those at which they are strongest, and, as a result, all bearings to which I shall refer were read as minima. By the addition of a suitable value of resistance in the "search-coil-detector" circuit of this type of D.F. receiver it is now possible to reduce one of these minima more than the opposite one, and so to determine the actual direction of a transmitting station as distinct from the line in which it lies on either side of the receiver. This is but a minor point, however, and does not actually bear upon our present considerations.

To ensure good reception the dimensions of the aerial must not be too small ; and therefore it is preferable that the reception for direction finding purposes should be carried out on the ground, since, in the air, space is limited, and excessive weight must be avoided. It is by no means impossible to work a D.F. instrument on either an airship or an aeroplane, but at present the instruments would necessarily be on a smaller scale than similar apparatus on the ground ; and furthermore, the degree of accuracy in determining the exact bearings from time to time would not be of so high an order. The aircraft, therefore, were equipped with standard combined C.W. and R/T sets, leaving all the D.F. work to the two ground stations.

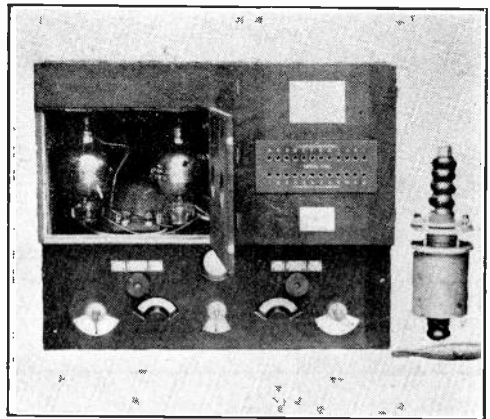

Main W/T Transmitter R36.

It is known that the earth's electric and magnetic fields have no appreciable effect upon the passage of electric waves, but that certain electric and magnetic manifestations can produce modifications. Variations of atmospheric inductivity and permeability, or in the degree of ionisation ; changes in geological and geographical structure, and local disturbing influences, are among the more important sources of error in direction finding wireless, but even these do not entirely explain all the disturbances experienced.

Broadly speaking, errors may be classified under two headings :—

(a) Those due to constant phenomena which can be accurately or semi-accurately corrected and allowed for; and

(b) Those due to inconstant phenomena, which vary from time to time, and for which no allowance can be made.

In the former class the most easy cases to deal

In our concluding remarks we shall return to these matters, but for the moment we must pass on to what happened on the two particular flights chosen for consideration.

Two tables of comparisons have been drawn up and are shown in Figs. 1 and 2 :—

Fig. 1.

R.33. Paris, Brussels, Antwerp Flight (July 5-6, 1921).

Time.	Ship's Position.	Croydon Error.	Pulham Error.
0012	(a)	0°	1½°
0613	(b)	1½°	2°
0710	(c)	1°	1°
0800	(d)	0°	0°
0903	(e)	0°	0°
1452½	(f)	1½°	1°
1639	(g)	0°	0°

Fig. 2.

R.36. Ushant Lizard Flight.

Time.	Ship's Position.	Croydon Error.	Pulham Error.
2340	(h)	2°	2°
0033	(i)	2°	1°
0232	(l)	0°	1°
0840	(n)	1°	1°
1235	(p)	½°	1°
1335	(r)	1°	2°
1434	(s)	1°	1½°
1939	(t)	1°	1°
2230	(u)	0°	0°
2258	(v)	0°	0°

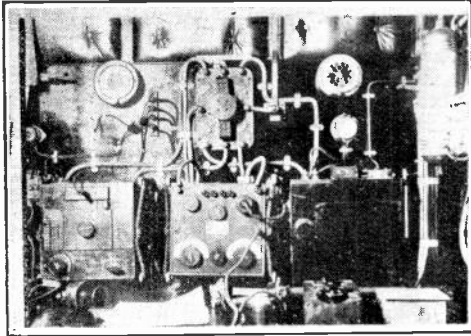

Internal view of R36 wireless cabin.

with are those of permanent features surrounding the D.F. station, and for which a steady correction can be made in the different quadrants. Absorption and screening effects due to soil of a poor conducting nature, or to large masses of matter, fall into this class, as do also the effects of reflection and refraction due to magnetic deposits, large metal sheds, houses, trees, and even railway lines.

Under the second group are met much greater difficulties. One is compelled to consider the influence upon waves passing along coast lines, alternately over land and water, over mountain ranges and a hundred and one other geographical features dependent upon the relative position of airship and ground station; and to consider the variations due to clouds, to thunder, to daylight and darkness, to fog and many similar matters. While these effects bear very largely indeed upon our errors we are yet almost more concerned with those which occur in the atmosphere itself.

The velocity at which a wave can travel at different heights above the earth's surface is doubtless not a constant figure. It has been shown that a reduction of inductivity occurs with a reduction of gaseous density at increased altitudes, thereby assisting electro-magnetic waves to follow the earth's curvature. And so there must be other disturbing influences at work in free space, and we are entitled to expect further sources of error. Should the alteration of the various properties increase the velocity of propagation as the height above the surface of the ground increases, then an initially vertical wave-front will tend to bend forward and downward, and at the same time it is conceivable that similar influences may effect the wave-front in a horizontal plane, giving rise to changes of direction along the surface itself. Uncondensed water vapour is known to change the inductivity of the air, and therefore to cause small deflections, so that we can account for unreliability in bearings during damp weather, in the neighbourhood of clouds and during fogs.

In the map showing the route followed in each flight (Fig. 3) the positions of the ship, at the times when the bearings were taken, are inserted as (a), (b), (c), etc., to correspond with the lettering in the second columns of Figs. 1 and 2.

Turning to Fig. 1, let us consider each position given and the bearings in each case from Croydon to Pulham.

At 12 minutes past midnight, when darkness was complete, we get an error of half a degree from Pulham and a completely accurate bearing from Croydon. It is observed that the Croydon bearing is taken completely overland while the Pulham bearing runs along and over the Essex and Kent coasts. Our error in this case is without doubt due to the coastline effect.

At 0613 day had finished breaking, and here we have an error of 2° on the part of Pulham. This bearing was taken probably before the atmosphere had reached any stable condition, and in addition the wave had passed over two coastlines and in close proximity to a third, and over some considerable distance of land. The Croydon bearing had passed over two coastlines only, and there is a smaller error of 1½°.

At 0710 the position of the ship was comparatively little changed, but we got a smaller error

from each D.F. station. The general electrical conditions had become more settled. Practically an hour later, with but a small relative movement on the part of the ship, we find no errors at all, both bearings being dead accurate; so that it is now quite likely that conditions for the day have become normal.

At 0903, the ship being just south-west of Valenciennes, there is again no error on the part of either station. There are no abnormal outstanding features in the country between this point and the two receiving stations.

Six hours later the ship is in the vicinity of Ostend, and here we get an error of 1° from Pulham and an error of $1\frac{1}{2}^\circ$ from Croydon, the latter attributable, no doubt, to the passage of the wave along the North Kent coast, and perhaps in a less degree

very acute angle as to make the plotting almost impossible. At nearly midnight we get errors of 2° and 1° from each station. In this connection it is of great interest to remark that on more than one occasion, when flying in these vicinities, errors have been experienced. On one occasion the speech from Croydon as heard in the ship's cabin, very loud at one moment, died suddenly away and for nearly a minute reception was impossible. At a later date, also during the night, a similar effect was observed from Pulham's signals. In each case the receiver was known to be in perfect working order, so that it would seem that there is some localised absorption effect present.

At 0232 we have an error of 1° from Pulham only, this bearing being taken for a long distance practically parallel to the Suffolk and Essex coastlines.

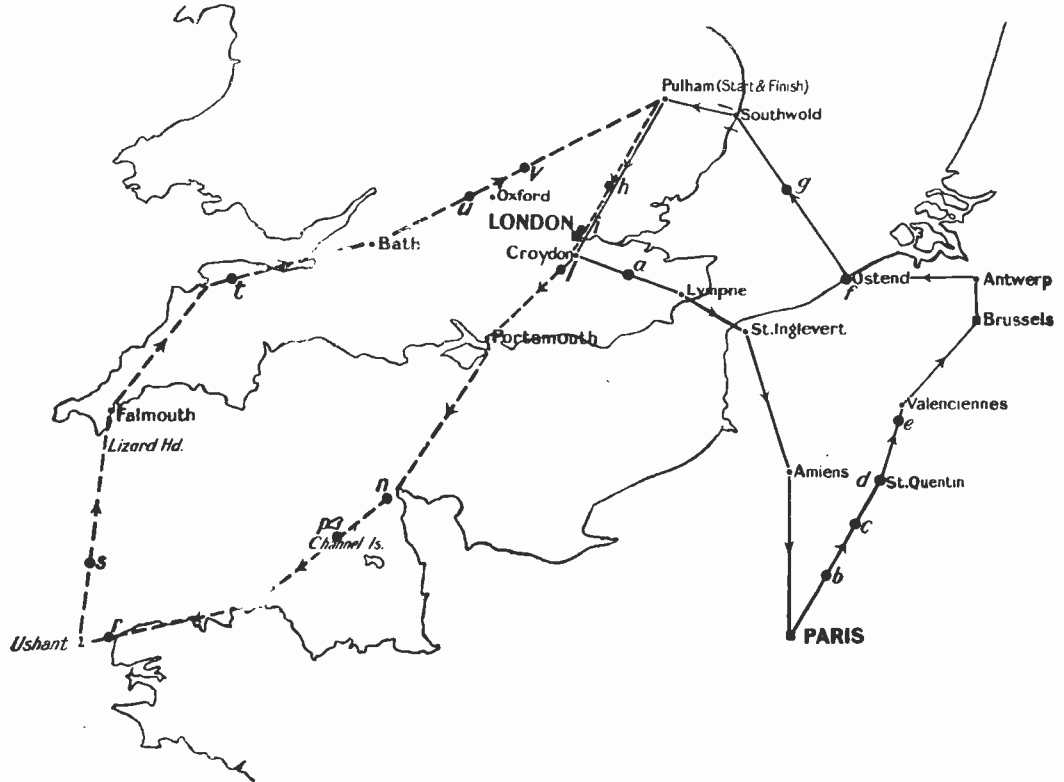

Sketch map of the Courses followed by R33 and R36 in flights iv. and vi.

to a local effect by the Belgian coast. At this time, also there was a heavy tendency to thunderstorms over England.

At 1639, the ship being then some distance out at sea, we get no error from either station. The Croydon reading is here taken practically regularly between two coastlines, and the night effect is not yet apparent.

In Fig. 2 our first bearings are again taken some time after nightfall, and the first two or three are difficult to plot because the ship and the two stations are to all intents and purposes in the same straight line. A cross-bearing is, therefore, unreliable because the two lines intersect at such a

At 0840 we have bearings taken in broad daylight showing in each case an error of 1° . Here again the stations and the ship are practically in the same straight line, so that each receiving station is subject to nearly all the same influences. The coastline effect upon the last bearing is not, however, manifest for some reason or another.

At 1235 there is little relative change in the position of the ship, and now we have errors of $\frac{1}{2}^\circ$ and 1° , probably due to the decreased influence of the French mainland.

At 1335 we have an error of 2° by Pulham and 1° by Croydon. This bearing is taken at a point practically remote from the influences of any large

coastline, while Croydon's error is doubtless due to some British coastal effect. Pulham's reading, though subject to the same general influences, is taken over a greater distance, which may account for the increased error of 1° .

At 1434 we have an error of $1\frac{1}{2}^{\circ}$ by Pulham and 1° by Croydon, a result in conformity with the one obtained an hour previously.

At 1939 there is an error of 1° from each station, very likely due in both cases to the Bristol Channel coast.

Our remaining bearings are accurate ones, and are taken entirely overland.

What inferences can we draw then from these data? Firstly we have definite distortions apparent along a coastline, or alternately over land and water. Other conditions being equal, the greater the distance between the ship and the coast the less the error. There is, then, a difference between the velocity of the wave over the surface of the ground and over the surface of the sea, and it would appear that the rate of motion is slower inland than over the water, resulting in a tendency for the wave to change direction from sea and shore.

Secondly, the conductivity of the ether varies with the change from daylight to darkness. During the transitional period, twilight, the accurate determination of a bearing becomes unreliable and sometimes impossible. At one or two periods at which bearings were attempted by the ground stations a complete absence of any minimum was found, and no appreciable difference could be noted between the received signal strengths at any position of the search coil. Again, at other times the received signal became so weak as to be practically inaudible. A method of correction for such variations is extremely difficult to find because we have yet to discover to what causes the errors are due. It has been suggested that the waves are subjected to processes of diffraction, or breaking up by ionised layers, but the true state of affairs has yet to be thoroughly investigated.

It will be noted that generally speaking the errors occurring have the least value when the ships were flying head-on to the stations, while the maximum errors occurred when the ships were transmitting beam bearings. At the greatest distances between ships and stations the variations appear greatest, or, in other words, the error varies directly as the distance.

A trailing aerial of some 300 feet was used in all these transmissions from the ship, so that some slight directional effect may have been present, but it may have been so small as to make but little difference in the majority of cases. It would be interesting to observe the results which would be obtained with an aerial of a fixed type having no directional value, for it is not unlikely that with a decrease of any directive transmission effect a decrease would occur in the D.F. error.

Most of the larger errors, again, were obtained when the ships were flying at a height above the normal (2,000 feet), at which these flights were performed, so that it could be reasonably suggested, though not actually proved, that the errors are different at different altitudes.

Atmospheric electrical effects, fog, thunder, rain and other clouds, give rise to errors, which vary according to the size and distance of the disturbing element. It might be suggested that such

factors having electrical capacity and frequencies of their own, would have more effect on certain wavelengths than on others, and therefore, that the D.F. bearings taken of two similar simultaneous transmissions, but on different wavelengths, would differ from each other.

Detuning or inaccurate transmissions appear to have no effect upon the magnitude of the error.

To condense our conclusions still further we may say that:—

1. Bearings should not be regarded as being of a high order of accuracy during the periods of twilight and dawn.
2. Greater difficulty is experienced in obtaining accurate bearings during the night than during the day.
3. Great care must be taken in obtaining bearings over coastlines, particularly in cases where the wave is moving in a direction parallel to the coastline.
4. Aircraft bearings may be expected to vary with the aircraft's course, distance and height.

In addition to this work the question of taking D.F. bearings upon the ships themselves was considered. In some respects, particularly when flying over those parts where few D.F. stations exist, it would be more satisfactory to reverse the system which we have hitherto considered, and, using the transmission of an ordinary ground wireless station, take a bearing of that station from the air. To do this it is necessary to carry direction-finding apparatus as part of the airship's wireless equipment. It will be appreciated that the majority of work carried out by the airship wireless operator will be at fairly long ranges, so that the fitting of frame aerials is almost out of the question unless we include amplification of a very high order. The field for investigation, therefore, lies in the direction of an adaptation of the Bellini-Tosi method. Both methods, however, were tried. The first step taken was to fix a rotating frame aerial in the keel of the ship, but it was found that the errors due to the large masses of metal forming the girders and general structure of the ship itself, were prohibitive. It therefore became imperative to place the frame aerial outside the keel, and a considerable number of positions were tried, but errors, due to the ship, were still very troublesome. Then the question arose of installing the coil at some point remote from the ship, and various plans were discussed, the outcome of which was the suspension of a platform below the ship and hanging in mid air. The arrangement was tried, with the ship riding at the mast; and at a distance of some 60 feet below the envelope it was found possible to obtain reliable bearings. For flying purposes, however, it was manifest that such an arrangement could not be used. A small gondola was designed totally enclosing operator and instruments, which succeeded in pursuing a reasonably steady course through the air to allow of useful bearings being taken from it while the ship was in flight.

Before any further work could be completed in this direction, however, the airship programme came to an abrupt conclusion.

Experiments with the Bellini-Tosi type of apparatus were carried on along different lines. Two loop aerials, of a similar form to those used at the ground stations, were dropped beneath the ship.

Here again the work was interrupted when the airships ceased flying.

And here, for the time being at any rate, commercial wireless work on airships stands.

Should the airship ever appear in the sky again as either a weapon of warfare or for more peaceful commercial enterprise, there is no doubt that a wide field for experiment will be reopened to the aircraft wireless engineer.

Were I to attempt to describe all the wireless work that was carried out I should not finish my remarks this evening, but suffice it to state that beyond this D.F. programme there were some most interesting results obtained both in telegraphic and telephonic work which promised reliable commercial communication should occasion ever make the demand.

Before concluding my paper I feel it proper to take a quite unique opportunity which has been afforded me this evening. Recently an important step was taken in changing the name of this Society from that of the Wireless Society of London, a name which it has borne for quite a number of years. The alteration, of course, speaks for itself, and is a tangible result of the very large and useful part taken by the British amateur in helping to develop the science of Radio. If I am permitted to claim the honour of having been one of the early members in the days of its infancy before the Great War, I feel I can now also claim the additional honour of having been the one first called upon to read a paper before the "Radio Society of Great Britain," and in doing so I am more than glad to take such an opportunity of wishing it many years of well merited success.

Greeting for the Prince of Wales.

The Prince of Wales, Patron of the Radio Society of Great Britain, received a message from Sir William Noble, Chairman of the British Broadcasting Company, during his visit to Devonshire

House is radio concerts, and Sir William Noble's message was transmitted by wireless from Marconi House and received by the Prince in the salon. On behalf of the whole wireless industry Sir William

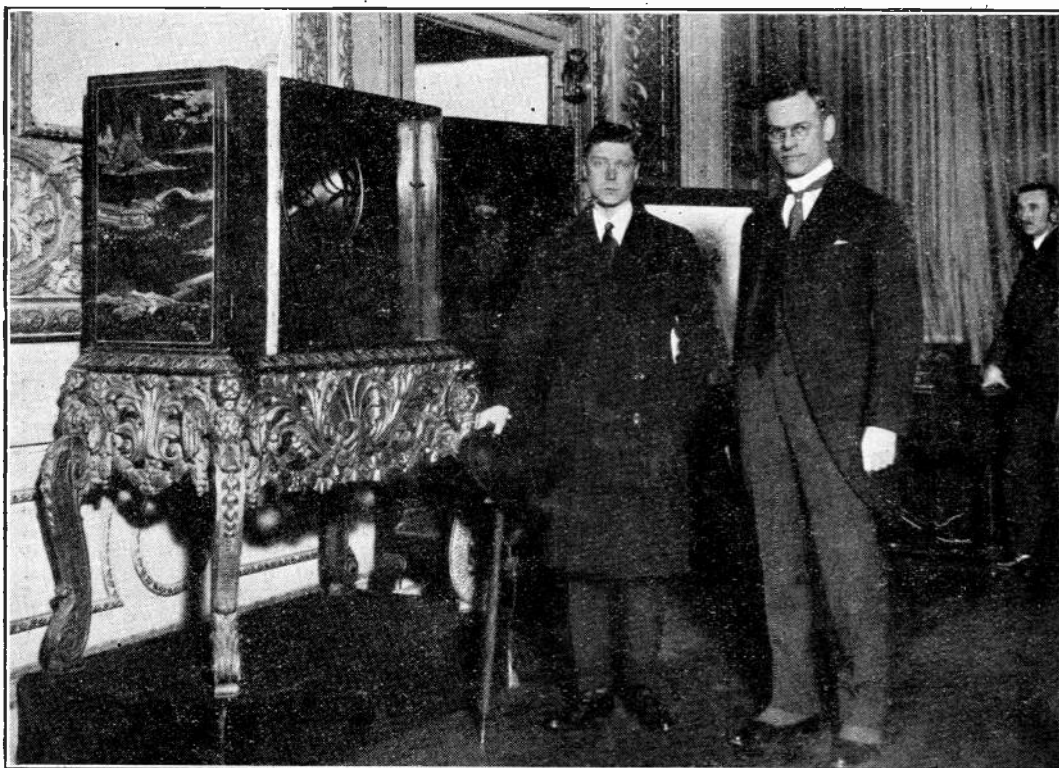

House. His Royal Highness is the President of the Hospitals of London Combined Appeal, on behalf of which cause Devonshire House is being used. One of the attractions at Devonshire

wished the Prince of Wales "a long life of happiness and continued leadership of this country's thought in clean sportsmanship, sympathy with the unfortunate, and high ideals in all life's problems."

Wireless Club Reports

NOTE.—Under this heading the Editor will be pleased to give publication to reports of the meetings of Wireless Clubs and Societies. Such reports should be submitted without covering letter and worded as concisely as possible, the Editor reserving the right to edit and curtail the reports if necessary. The Editor will be pleased to consider for publication papers read before Societies. An Asterisk denotes affiliation with the Radio Society of Great Britain.

Correspondence with Clubs should be addressed to the Secretaries direct in every case unless otherwise stated.

Clapham Park Wireless Society.*

The fifteenth general meeting was held at headquarters, 67, Balham High Road, at 7.30 p.m. on Wednesday, December 6th, 1922.

Mr. A. E. Radburn was elected Chairman.

The Chairman called upon Mr. Moir, of the Radio Association, Organiser, of 44, Great Russell Street, Head Offices, London, W.C.1., to ventilate the objects and aims of his Association, and explain advantages to the C.P.W.S. of affiliating therewith.

Mr. Moir touched upon the plight of the experimenter and manufacturer under the proposed B.B.C. The speaker outlined the aims of the Association, after which many questions were asked, giving rise to a lively discussion.

Mr. Sinclair proposed and Mr. Brierley seconded a hearty vote of thanks to the speaker, who suitably replied in appreciation.

Finally Mr. C. D. Richardson kindly offered to be in attendance with his apparatus on Wednesday afternoon, December 13th, with the Hon. Treasurer, and see what could be done with actual "listening-in," Mr. R. H. J. McCue, Mr. Hurst, and Mr. Radburn also offering their services.

It was agreed that the meeting of December 13th would be the last for the present year, the following meeting to take place on the first Wednesday in the New Year, January 3rd, 1923.

The Hon. Secretary then announced that Mr. Brierley having intimated to the Hon. Treasurer his having to probably postpone his demonstration on December 13th, the Hon. Secretary acting, as he thought in the interests of the C.P.W.S., deemed it advisable to make tentative arrangements for a Radio Society of Great Britain representative to place before the Society the advantages of affiliation with them.

Mr. Prout proposed and Mr. R. McCue seconded that the Hon. Secretary's action be confirmed, and that the Radio Society of Great Britain representative be invited.

Newport and District Radio Association.*

Hon. Secretary, Mr. E. R. Brown, 92, Corporation Road, Newport.

A very successful wireless concert, transmitted by Captain C. H. Bailey (Vice-president), was given at the Temperance Hall, Newport, on December 7th. Alderman Dr. McGinn presided. A film also was shown.

Belvedere and District Radio and Scientific Society.*

Hon. Secretary, Mr. S. G. Meadows, 1, Kentish Road, Belvedere, Kent.

At the meeting on December 8th a lecture was given by Mr. G. N. Hurst, A.M.I.E.E., on "Directional Wireless." Electrical and magnetic components were simply explained. The properties of a loop aerial were investigated, and the radio-phare was described. Questions were replied to.

During the last half hour 2 LO was received on the Society's apparatus.

Sheffield and District Wireless Society.*

Hon. Secretary, Mr. L. H. Crowther, A.M.I.E.E., 18, Linden Avenue, Woodseats, Sheffield.

At a meeting on December 1st, Mr. H. Lloyd, the Chairman of the Technical Committee, constructed before the audience a four-valve receiving set. Each part, as completed, was passed round for inspection, and the workmanship, down to the finest detail, received general commendation.

The first two panels having been completed, the set was connected to the Society's aerial, and broadcasting from Manchester Station was received. The four valves were then connected up. Mr. Lloyd presented the set to the Society for their own use.

Huddersfield Radio Society.*

Hon. Secretary, Mr. C. Dyson, 14, John William Street, Huddersfield.

On December 12th, Mr. T. Brooke in the chair, and about 40 members present, an interesting lecture on "Wireless Telephony and Systems of Modulation" was given by Mr. J. Beaver (2 QK), of the Bradford Wireless Society. The various systems of transmitting circuits and their control were described.

Wolverhampton and District Wireless Society.*

Hon. Secretary, Mr. J. A. H. Devey, 232, Great Brickkiln Street, Wolverhampton.

An Exhibition of wireless sets was held on December 13th, the chief objects being to show the various efforts made by members at building their own sets.

The Chairman, Mr. H. H. Speke, in announcing the prizewinners, paid a high tribute to the individual interest and ability of all the exhibitors.

Newcastle and District Amateur Wireless Association.*

Hon. Secretary, Mr. Colin Bain, 51, Grainger Street, Newcastle-on-Tyne.

After the business of the meeting had been dealt with on December 4th, the Chairman, Dr. Smallwood, presented to Mr. W. G. Dixon a smoker's cabinet, which had been subscribed for by the members in acknowledgement of recent active efforts on behalf of the Society. Mr. Dixon replied.

At the meeting on December 11th, a resolution was passed in protest to "Clause 2" of the Broadcasting Licence, and the hope was expressed that this clause would be altered, at least as far as imported apparatus required by those holding experimental licences was concerned.

Notice was given by the Secretary that at a later meeting it would be moved that the word "Wireless" should be deleted from the Society's title, and the word "Radio" should be substituted for it.

West London Wireless and Experimental Association.*

Hon. Secretary, Mr. Horace W. Cotton, 19, Bushey Road, Harlington, Middlesex.

Mr. C. A. Hillyer gave a paper on "Measuring Instruments, Part I," on November 10th. With the aid of blackboard diagrams, various types were described.

On November 24th, Mr. C. A. Hillyer gave Part II of his paper.

Wireless Society of Hull and District.*

Secretary's address: 79, Balfour Street, Hull.

Mr. J. Nicholson, on December 11th, lectured on the "Construction of Various Types of Inductance Coils." He touched upon the Phillips Rejector Circuit, and this caused some discussion.

Mr. Hy. Strong (Acting Vice-President) occupied the chair.

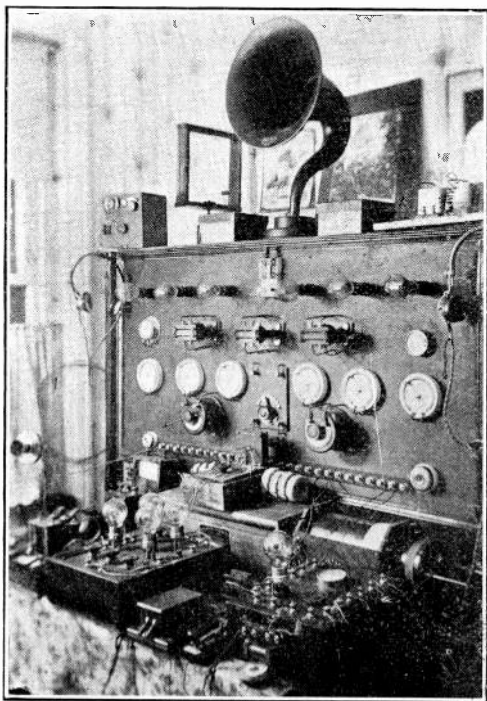

Mr. E. Jones' Station 2 TZ at Offerton, Stockport.

Sutton and District Wireless Society.*

Hon. Secretary, Mr. E. A. Pywell, Stanley Lodge, Rosebery Road, Cheam.

Meetings are now held on the second and fourth Wednesdays in the month from 8 to 10 p.m. at the Adult School, Benhill Avenue, Sutton.

At the meeting on December 13th, Mr. C. H. P. Nutter gave a very interesting talk on the T.F. three-valve receiver. It was hoped that on December 27th Mr. Ely would be able to give a lecture on X-ray work.

On Thursday, December 14th, a successful demonstration of wireless reception was given

and during the evening over 150 people were able to enjoy music transmitted from London, Birmingham and Manchester.

Sunderland Wireless and Scientific Association.*

Hon. Secretary, Mr. A. Richardson, Westfield House, Sunderland.

On December 16th, Mr. A. J. C. Davis, of Marconi's Wireless Telegraph Company, lectured on "Wireless Direction Finding." The lecture was amply illustrated by excellent slides.

The meeting heartily carried the motion of thanks to the lecturer proposed by Mr. Gibbons.

Finchley and District Wireless Society.*

Hon. Secretary, Mr. A. E. Field, 28, Holmwood Gardens, Finchley, N.3.

This Society, which has made rapid strides of late and whose membership is steadily increasing, has now, unfortunately, to change its headquarters. Members are asked to remember not to attend until they hear from the Secretary as to where the new headquarters will be.

The Society has a very attractive programme for the new year; several lectures and demonstrations have been arranged.

Portsmouth and District Amateur Wireless Association.

Hon. Secretary, Mr. S. G. Hogg, 9, Pelham Road, Southsea.

To close the year's activities, the above Association gave a very pleasant social evening and wireless exhibition to the members and their friends on December 6th. By kind permission of General Ferrié, of Paris, a special concert was transmitted on that date. Mr. Stevenson demonstrated Wireless Control.

On December 13th, the club held its annual meeting with a re-election of officers. Mr. J. H. C. Harrold, A.M.I.R.E., was elected President of the club for the forthcoming year, with Mr. S. J. Beckett as Vice-President. Mr. Gall was re-elected Treasurer. The new Secretary of the Association is Mr. S. G. Hogg. The club hopes to start the new year in more commodious premises in Fratton Road, Portsmouth, but all enquiries may be sent to the Hon. Secretary at the address above. It was decided at this meeting that the club should apply for affiliation to the Radio Society of Great Britain.

Guildford and District Wireless Society.

Hon. Secretary, Mr. Rowland T. Bailey, 46, High Street, Guildford.

More commodious and central rooms have been acquired at 148, High Street, Guildford, and with the help of members generally it is hoped to much improve the Society's "set," and establish a library.

On December 11th, Mr. W. C. Dolton, M.I.E.E., lectured on "The Thermionic Valve." Several different types of valve were exhibited, and explained.

The meeting on December 18th was open for general discussion. This meeting was the last in the old headquarters.

Warrington Radio Association.

Hon. Secretary, Mr. J. Barton, 266, Lovely Lane, Warrington.

A meeting was held on December 14th in Atkinson's Café, Bridge Street. The proceedings were informal. Mr. W. H. Taylor (Vice-Chairman) pointed out that Warrington and District was capable of supporting a large and prosperous Society. He then discussed the installation and maintenance of an aerial.

Mr. Oscar Harris, the Hon. Treasurer, gave a short address.

Horwich Radio Society.

Hon. Secretary, Mr. P. Ashurst, 51, Mary Street, E. Horwich, Nr. Bolton.

A meeting at 91, Lee Lane, Horwich, on December 5th, decided to form a Society under the above title. The subscription was fixed at 10s. per annum and 2s. 6d. entrance fee for gentlemen and 5s. per annum and 2s. 6d. entrance fee for ladies. The age limit was fixed at 18 years of age. The following were elected to office: Chairman, Mr. P. Fairclough; Hon. Treasurer, Mr. C. Holt; Hon. Secretary, Mr. P. Ashurst. A sub-committee was formed to view a room in The Reform Club with a view to renting it.

At the next meeting it was decided to accept a room in The Reform Club for use as a club-room, and all members were asked to give their support in cleaning and fitting up the room.

The following were elected to office:—Vice-Chairman, Mr. Marshall; and Room Secretary, Mr. Isherwood.

Cowes District Radio and Research Society.

Hon. Secretary, Mr. L. Ingram, 1, Mill Hill Road, Cowes.

On and after January 1st, 1923, the Headquarters of this Society will be at the Gloster Restaurant, High Street, West Cowes.

"Experiences of Field Wireless during the Late War," was the subject of a talk given by Mr. Hartridge on November 1st.

Mr. Mugliston lectured on "The Principles of Tuning" on November 8th. "The Elementary Principles of Wireless" was the subject of a lecture by the Hon. Vice-President, Mr. A. Taylor on November 15th. A lecture on "X-Rays, its Developments and Uses," was given by Mr. Wallace, A.M.I.E.E., a Vice-President, followed by a practical demonstration.

Membership subscription to this Society is 7s. 6d. per annum.

Leeds Y.M.C.A. Wireless Society.

Hon. Secretary, Mr. N. Whiteley, Wireless Section, Y.M.C.A., Albion Place, Leeds.

At a general meeting on December 11th, it was unanimously decided to form a society for the study of wireless matters under the above title.

The chair was taken by Mr. H. Mills, the General Secretary of the Leeds Y.M.C.A., who explained the attitude of the Council towards the formation of such a society. Questions were invited and answered. Mr. Mills then retired, and Mr. N. Whiteley was elected chairman pro tem.

The following officers were duly elected:—President, Mr. J. C. Innes (Chairman of Y.M.C.A.

Council) and successive Chairman: Hon. Secretary, Mr. N. Whiteley; Assistant Secretary and Treasurer, Mr. F. Hirst; Committee, Messrs. Parker, Boocock, Mayne, and Cooper. It was decided to leave the appointment of Vice-President open for the time being. It was decided that meetings be held at the Y.M.C.A. at 7.30 p.m. weekly on Mondays; section subscription to be 2s. 6d. per annum; application for an experimental licence be proceeded with immediately; Rules be formulated by the Committee and put before a general meeting at an early date. At the conclusion of the business several members were enrolled. Mr. R. H. Toynbee was elected Chairman for the meeting on December 18th.

Burnham, Highbridge and District Wireless Society.

Hon. Secretary, Mr. L. Lott, 52, High Street, Burnham-on-Sea.

The Technical Education Authorities have granted the use of a room at the Technical Institute, Burnham-on-Sea, for the holding of meetings. Papers have been given and considerable progress made. The single valve Armstrong super circuit was demonstrated, and a visit paid to the home station of the Hon. Secretary, when a full muster of members turned up.

Pudsey and District Wireless Society.

Hon. Secretary, Mr. W. G. A. Daniels, "The Wharrels," Low Town, Pudsey, near Leeds.

On December 11th a demonstration of telephony reception was given by Mr. Wild at the Society's temporary club-room. The transmissions from the Manchester broadcasting station 2ZY were received on a loud speaker.

Several new members were elected after the meeting.

Southend and District Wireless Club.

Hon. Secretary, Mr. R. L. When, 4, Wimborne Road, Southend-on-Sea.

On December 8th a lantern lecture was given by Mr. A. C. Hugh on "Development in Radio Telegraphy." Lantern slides were kindly lent by the Marconi Company. A general discussion followed each slide shown.

The Chairman, Mr. Plaistowe, announced that several of the members had undertaken to construct a Johnsen-Rahbek loud speaker, and were requiring material, which members readily offered to supply. Mr. Mayer (2LZ) offered to lend apparatus for a demonstration at the next meeting.

Ashton-under-Lyne and District Radio Society.

Hon. Secretary, Mr. James Hy. Marshall, 22, Warrington Street, Ashton-under-Lyne.

An enthusiastic meeting of wireless workers at Livesey's Café, on December 11th, decided to form a Radio Society, every person present becoming a member. Others unable to be present brought up the first membership to 40.

The following provisional officers were appointed: President, Dr. Bleasdale; Secretary, Mr. J. H. Marshall; Assistant Secretary, Mr. Sidney Buckley; Treasurer, Mr. H. Draycott; Committee, Messrs. Goldthorpe, Etechells, Davies, Ashworth, Cropper, Morois; Technical Adviser, Mr. Leslie Gordon.

Notes

The British Broadcasting Company, Ltd.

This Company has been incorporated for the purpose of instituting and conducting the broadcast wireless service, and was duly registered on December 15th. Lord Gainford has consented to be chairman of the Company. The head office will be in the buildings of the Institution of Electrical Engineers, Savoy Street, W.C.

Cardiff Broadcasting Station.

We understand that the British Broadcasting Company's offer to rent rooms at the Eldon Road Works has been accepted by the Cardiff Electricity Committee. The purpose of the tenancy, we understand, is for the broadcasting station for that area.

A Selective Five-Valve Amplifier.

In the paper read by Mr. Maurice Child before the Radio Society of Great Britain, and reported on page 343 of our issue of December 9th, a reference was made to the most suitable values for the leak resistances in the grid circuits of the H.F. valves. Mr. Childs wishes it to be added that the values of these leaks should be of the order of 500,000 ohms for the second valve, and 200,000 ohms for the third valve, in order to limit the tendency to self oscillate.

The photographer who produced the illustrations in that article was Mr. P. H. Jenkins.

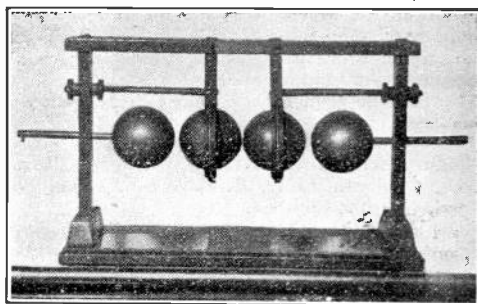

The above photograph is of interest. It illustrates an early spark gap used in early experiments with the Marconi system. The apparatus is now in the museum at the General Post Office.

Scandinavian W/T Rates Reduced.

At the Conference of Telegraph Delegates from Denmark, Norway and Sweden, held at Copenhagen, it was decided to reduce wireless telegraph rates from coastal stations from February, 1923.

Transatlantic Tests.

Since the commencement of the reception tests of the signals transmitted in America, reports have come to hand daily, indicating good reception of a large number of American stations.

London Broadcasting Station.

In the description of the London Broadcasting Station in our issue of December 23rd, it was omitted to mention that the apparatus was designed and installed by Marconi's Wireless Telegraph Company, Ltd.

Calendar of Current Events

Friday, December 29th.

BRADFORD WIRELESS SOCIETY.
At 5, Randallwell Street, Bradford. Annual Meeting.

Sunday, December 31st.

3.5 p.m. *Daily Mail* Concert from PCGG, The Hague, on 1,050 metres.

Monday, January 1st.

9.20-10.20 p.m. Dutch Concert, PCGG. The Hague, on, 1,050 metres.

IPSWICH AND DISTRICT WIRELESS SOCIETY.
At 8 p.m. At 55, Fonnereau Road. Lecture on "Primary Batteries," by Mr. Bird.

Tuesday, January 2nd.

Transmission of Telephony at 8 p.m., on 400 metres, by 2 MT Writtle.

Wednesday, January 3rd.

REDHILL AND DISTRICT Y.M.C.A. WIRELESS SOCIETY.

At 111, Station Road, Redhill. Lecture on "Direction Finding."

MALVERN WIRELESS SOCIETY.
Lecture on "Valve Amplification."
PHYSICAL SOCIETY OF LONDON AND THE OPTICAL SOCIETY.

At the Imperial College of Science, South Kensington. Annual Exhibition. Members of the Radio Society of Great Britain are invited. (Also on following day.)

Thursday, January 4th.

At 9.20-10.20 p.m. Dutch Concert from PCGG,* The Hague, on 1,050 metres.

MANCHESTER WIRELESS SOCIETY.
At 7 p.m. At the Council Chamber, Houldsworth Hall. Lecture on "Screening Effects on Aerials," by Mr. B. L. Stephenson.

HACKNEY AND DISTRICT RADIO SOCIETY.
Annual General Meeting.
HOUNSLOW AND DISTRICT WIRELESS SOCIETY.
At Headquarters, Council House, Treaty Road, Hounslow. Lecture on "Wireless—Pastime and Professional," by Mr. S. H. Nayler.

Friday, January 5th.

EDINBURGH AND DISTRICT RADIO SOCIETY.
Lecture on "Capacity and Inductance," by Prof. F. G. Baily, M.A.

LEEDS AND DISTRICT AMATEUR WIRELESS SOCIETY.
General Meeting. Lecture on "Transmission of Photographs by Wireless," by Mr. T. Brown Thomson.

Communication with Aeroplanes.

An Air Ministry notice to airmen, respecting alternative cross-channel air route weather reports, states:—1. When bad weather conditions prevail on the normal air route between Croydon and the Channel, reports from certain stations on an alternative route are now available at Croydon and Lympne for communication to pilots of machines in flight. 2. The places for which information is available at these times are the Isle of Grain, North Foreland and Deal.

Correspondence

To the Editor of THE WIRELESS WORLD
AND RADIO REVIEW.

SIR,—Now that the use of the 440 metre wave is curtailed for amateur use by advent of broadcasting, I thought it would interest your readers to hear that very good results can be obtained on the lower band 150-200 metres. During last week I have read the following stations:—2 FP, 2 JZ, 2 LZ, 2 OD, all strength 7, and telephony from 2 ON, strength 5, all between 150-200 metres.

The nearest of these is over 200 miles, and 2 JZ is over 500.

For this reception only two valves were used, one tuned anode and detector, with aerial of four wires. Length 40 ft., mean height, 35 ft. Due North and South.

34, Coldrenick Street, E. W. PENNEY.
Plymouth.

To the Editor of THE WIRELESS WORLD
AND RADIO REVIEW.

SIR,—There is a considerable amount of apprehension existing amongst amateurs and others experimenting with the Armstrong Super-regenerative circuits in conjunction with frame aerials, with regard to the possibility of radiation of a somewhat powerful nature.

In the middle of October I made a series of experiments with a three-valve Armstrong regenerative receiver employing A.T. 40 valves with an anode potential of 400 volts, using a frame two feet square.

This arrangement, as will be realised, gave rise to considerably strong harmonics, but did not cause any interference whatsoever at the station of Mr. Aubrey Garnett, which is situated 200 yards from my house, while working on the same wavelength at the same time.

December 4th, 1922. W. K. ALFORD.

British Empire Exhibition (1924).

Radio telegraphy and telephony will be provided for in the list of exhibits at the forthcoming British Empire Exhibition (1924) to be held at Wembley Park from April to October, 1924. Group XIV Classes 35 and 36 are defined as follows:—

Telephony, Class 36.—Telephone instruments, transmitters, receivers, and accessories; testing and protective appliances; manual and automatic switching equipment; speech amplifiers and telephone repeaters.

“Carrier Wave” and wireless telephony; telephone multiple cables and loading coils.

Telegraphy, Class 37.—Apparatus and accessories; hand-worked telegraphs; Wheatstone automatic transmitters and receivers; machine and type printing telegraphs; high speed repeaters.

Wireless telegraphy.

Line construction material and appliances; submarine cables.

Ebonite is included in Group XXIX, Class 89. Military telegraphy and telephony are placed in Group XLIII, Classes 137 and 138.

The offices of the promoters of the exhibition are at 16, Hobart Place, S.W.1.

Book Review

WIRELESS TELEPHONY FOR ALL. By Lawrence M. Cockaday. (London: Herbert Jenkins, Ltd.)

Considering the enormous interest which America displays in amateur wireless, it is only to be expected that she should contribute freely to the literature of the subject. The English amateur, no less enlightened than the American “ham,”* nevertheless welcomes a really good American book about his hobby as warmly as he accepted the co-operation of “the other side” in making the broad Atlantic a mere standing jump for amateur wireless transmitters.

In the book under review, which Mr. Herbert Jenkins has produced very attractively and sells at a reasonable price, we recognise a tone to which the heart warms, that of the fellow who wants to share a good idea with anybody who is not too high and mighty to listen. Mr. Cockaday is a most companionable person, to judge by his book and its frontispiece, which reveals him in his den amidst a glorious collection of apparatus.

This book, which is just the very thing for the beginner who is perhaps entering the game by the door of “broadcasting,” presents a simple and lucid explanation of the principles of wireless telephony, and includes enough practical matter to enable the reader to make a start, without being too much like a handbook for amateur carpenters.

One hesitates to criticise in detail a work so good as a whole, but for the sake of future editions we ought to point to page 24 and suggest that the author might well explain what a fundamental difference exists between the nature of sound waves and aether waves.

I do not think that many engineers in this country—or even in America—will agree with Mr. Cockaday’s opinion that in inventing the regenerative circuit Armstrong “has contributed what is universally acclaimed the greatest and most important invention since wireless was first conceived.” I defy anybody to give the date of that event, but I should say that Senatore Marconi’s humble inventions were made somewhat later and that the thermionic valve is incontrovertibly the most important post-Marconi invention.

E. B.

New Catalogues

Messrs. Ward and Goldstone, Frederick Road, Pendleton, Manchester. List No. A/24. (Wireless Section, pp. 51-61.) Also pamphlet relating to Broadcasting Receiving Sets.

Wireless Fog Signals.

On the invitation of the Northern Lights Commissioners a party of representative officials visited Inchkeith, Firth of Forth, to attend a demonstration of wireless beam fog signals conducted by the Marconi Wireless Telegraph Co., Ltd. The apparatus consists of a reflector, which revolves and gives the bearing in which it is pointing. Experiments were carried out over a range of about nine miles, and proved satisfactory.

*In the States a “ham” is to amateur wireless what a “fan” is to baseball, but he is more practical and less vocal.

The Problem of Aerial Insulation and a New Type of Aerial Insulator.

By H. P. WARAN, M.A., Ph.D. (Cantab), F. Inst. P.

THE problem of insulating the aerial perfectly is beset with a great many difficulties, and every experimenter begins to realise sooner or later that the insulation provided by some insulators on the market is far from perfect. Even though all of them appear satisfactory enough for the purpose at the beginning, the difficult atmospheric conditions of the open air leads to a rapid deterioration of the insulation within a few weeks or days in a busy smoky industrial locality. The ordinary porcelain insulators of the reel, egg or shell type, afford too short a resistance path to be effective, and are often known to fail on account of even a mere film of water in wet weather. But a greater source of trouble arises from the gradual deposit of smoke and dust from the dirty atmosphere of busy cities, and even a very thin film of it suffices to conduct away the high tension and high frequency currents used in wireless.

The various types of ebonite and composition insulators are, in a sense, inferior to the porcelain insulators for more than one reason. Substances of the nature of ebonite are all well known to lose their insulating property on long exposure to light in the open air. They are good enough when used indoors, and even then their surface ought to be unpolished and kept rough and fresh by the periodical application of emery paper if a high state of insulation is to be maintained. If used outside, smoke and dust get lodged on their surface more readily than on porcelain, and there is not even the hope of a good heavy rain being able to wash it off. Thus, even though some of these when used in series and when periodically taken down and kept clean are found good enough in receiving aerials, they are never satisfactory enough to stand the high tension of transmitting aerials without considerable leakage and loss of efficiency.

Glass of suitable composition as an insulator is sometimes superior to ebonite, porcelain, or other material, and when properly designed seems to provide almost perfect insulation. The principal points to be attended to in the design of an insulator for high tension and high frequency currents are: (1) The resistance path across the insulator must be as long as possible. (2) The resistance path along the surface must be covered and protected as far as practicable from external influences of

the weather and the atmosphere. (3) It should have the requisite tensile strength.

Designed on these scientific lines a new table blown-glass insulator has been recently introduced into the wireless market.* The two types in which the insulators are now being made are illustrated in Fig. (a), (b). The

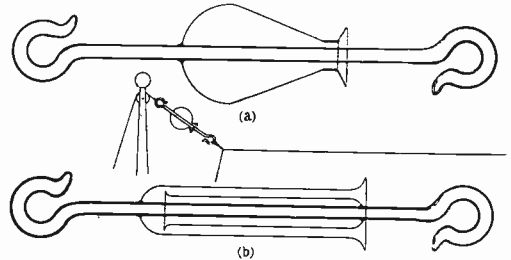

Sketches of the Insulators described.

insulator is simply a stout walled long glass tube bent into hooks at either end, the central portion of this stem being almost completely encircled by a bulb sealed on to the stem. In the second type there are two such protecting jackets turned in opposite ways, and they are made cylindrical instead of being spherical. In such an insulator the resistance path along the surface is over a foot, even in the smaller sizes, and the central region being completely jacketed by the bulb, is kept clean and free from deposits of smoke, dust or films of moisture, and thus ensures perfect insulation, even in the worst of weathers and localities. Further, even the slight deposit over the highly glazed exterior surface gets readily washed away quite clean at the first rain. Thus a single one of these insulators provides a better insulation than half-a-dozen or more of the other types used in series. Though it is very light it is quite strong and able to stand the strain coming over any average sized outdoor aerial.

Some misgivings may be felt at the fragile nature of the glass. But what an aerial insulator should have is good tensile strength and not ability to stand kicks on its side. In this it is in no way inferior to porcelain or other composition, and all that it requires is only a little careful handling when putting it up, and when once up in the air it would look after itself.

* Messrs. Baird & Tatlock, Hatton Garden, London, E.C.

Questions and Answers

NOTE.—This section of the magazine is placed at the disposal of all readers who wish to receive advice and information on matters pertaining to both the technical and non-technical sides of wireless work. Readers should comply with the following rules:—(1) Each question should be numbered and written on a separate sheet on one side of the paper, and addressed "Questions and Answers," Editor, THE WIRELESS WORLD AND RADIO REVIEW, 12/13, Henrietta Street, London, W.C.2. Queries should be clear and concise. (2) Before sending in their questions readers are advised to search recent numbers to see whether the same queries have not been dealt with before. (3) Each communication sent in to be accompanied by the "Questions and Answers" coupon to be found in the advertisement columns of the issue current at the time of forwarding the questions. (4) The name and address of the querist, which is for reference and not for publication, to appear at the top of every sheet or sheets, and unless typewritten, this should be in block capitals. Queries will be answered under the initials and town of the correspondent, or, if so desired, under a "nom de plume." (5) In view of the fact that a large proportion of the circuits and apparatus described in these answers are covered by patents, readers are advised before making use of them, to satisfy themselves that they would not be infringing patents. (6) Where a reply through the post is required, every question sent in must be accompanied by a postal order for the amount of 1s., or 3s. 6d. for a maximum of four questions. (7) Four questions is the maximum which may be sent in at one time.

"F.S." (Nottingham).—The proposed arrangement is suitable, but as you get poor results, we assume the H.F. transformer is not satisfactory. Several designs for H.F. transformers have been given in recent issues, and we think you should have no difficulty in determining whether or not the H.F. transformer in use has suitable constants.

"G.R." (E.6) asks us to reproduce Fig. 2, page 880, September 30th issue, with the addition of switches for controlling the number of valves in circuit.

See Fig. 1. The figure shows double-pole double-throw switches connected.

"J.L.R." (Glasgow) cannot erect an outdoor aerial, and asks (1) Which is the best type of indoor aerial to use. (2) Are valve circuits made tunable. (3) How is one to know whether the first valve of a three-valve set (one H.F., one detector, one L.F.) is operating as H.F. amplifier and not as a detector.

(1) We suggest you use a loop aerial consisting of a 4' square frame wound with 12 turns of No. 18 D.C.C. wire spaced $\frac{1}{2}$ " apart. (2) H.F. valve circuits are usually tunable, but L.F. are not. (3) By using a suitable filament heating current and H.T. battery voltage. The detector valve has its grid circuit specially designed for rectification.

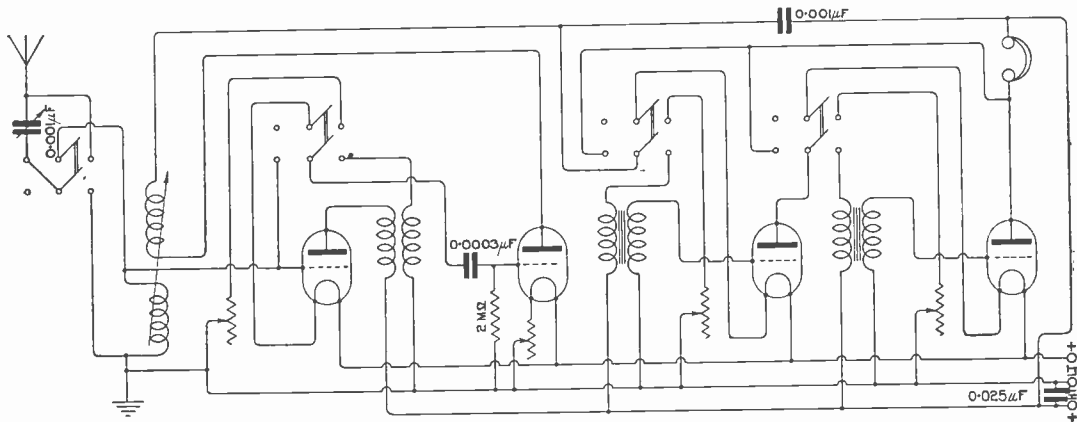

Fig. 1.

"BLACK" (Lowestoft).—(1) The reaction coil should be coupled with the anode coil, and may consist of 100 turns of No. 40 S.S.C. wire on a former $2\frac{1}{2}$ " diameter. For the longer wavelengths, coils may be added in series if required. (2) If you wish to conduct experiments, you should apply for an experimenter's licence, stating the nature of the proposed experiments. (3) We think you will have no difficulty in hearing the broadcast transmission when using a three-valve receiver.

"M.P.B." (Gironde) asks (1) Whether the index to Volume X. has been issued yet. (2) The gauge of wire to use in tuning coils. (3) Particulars of the variometer used in the Armstrong super-regenerative circuit.

(1) The index to Volume X. is now ready, price 8d. (2) We suggest you employ No. 26 D.S.C., and wind the coils on a former 2" diameter. (3) Full particulars have been given to "INTERESSE" (Brussels) page 317, December 2nd issue.

"W.B." (Liverpool) asks for a diagram of a our-valve set.

The diagram of a four-valve set on page 880, September 30th issue, is quite suitable for the purpose you suggest. The aerial tuning condenser is 0.001 mfd. The H.F. transformer tuning condenser should have a maximum value of 0.0002 mfd., grid condenser, 0.0003 mfd., grid leak resistance, 2 megohms, L.F. transformer by-pass condenser, 0.001 mfd., H.T. battery by-pass condenser, 0.05 mfd. The aerial tuning inductance may be a tapped coil, 4" diameter and 4" long, wound with No. 22 D.C.C. with 12 tapplings. For the long wavelengths a coil 4" x 8" of No. 26 D.C.C. may be used, with 12 tapplings. The H.F. transformer may be of the plug-in type or a tapped coil would perhaps give less trouble in operation. If the mean diameter of the transformer is 1½", 120 turns of No. 28 D.C.C. for primary and secondary will be suitable for operation over a wavelength range of 300-470 metres. For higher wavelengths more turns will be required. As you probably have back numbers of this journal by you, we suggest you examine the articles on "Experimental Station Design," which appeared in the issues of September 2nd and 16th. A variable H.F. trans-

down to the lead in tube on the ground floor it is not possible to make improvements. The wires which connect from the instrument to the lead in should be as short as possible, and the lead to earth should also be as short as convenient. We consider the 50' double wire aerial is the best arrangement, but we do not think it will be wise to connect two aerials to the same mast. Serious interference is likely to result, especially when valve receivers are used. Should you undertake transmission experiments at any time, it will be practically impossible for your neighbours to tune out your transmission.

"ANODE" (Manchester) asks (1) Whether the suggested switching arrangement, particulars of which are submitted, is suitable. (2) For particulars of a five-valve set using stud switches to cut in or out any valve.

(1) The proposed arrangement is not very satisfactory, because although the switches transfer the anode circuits, the filament and grid circuits remain connected. It would also be better if you used a switch in the aerial circuit to join the A.T.I. and A.T.C. in series or parallel. (2) You will obtain very satisfactory results by adopting the scheme shown on page 883, September 30th issue.

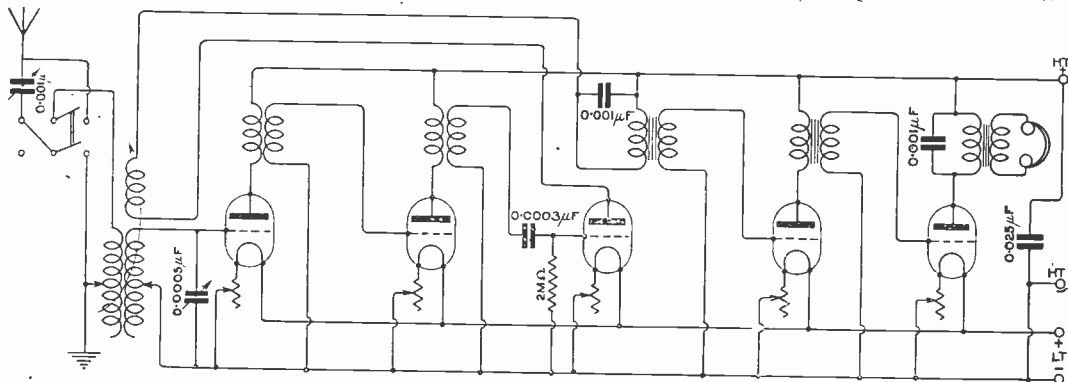

Fig. 2.

former which may meet your requirements is described on pages 828, September 23rd issue.

"J.J.R." (Atlantic Fleet) submits a list of components in his possession and asks for a suitable circuit.

See Fig. 2. The values of the condensers are indicated in the figure. The aerial inductance may be a coil of No. 22 D.C.C. wire wound on a former 5" diameter and 8" long with 18 tapplings. The secondary inductance may consist of a coil of No. 26 D.C.C. wire, wound on a former 4" diameter and 9" long. The reaction coil may consist of 100 turns of No. 28 D.C.C. on a former 3" diameter. We suggest you employ a 6-volt accumulator for heating the filament, and a 60-volt H.T. battery for the plate circuits. The telephones are not suitable for direct connection in the plate circuit. A telephone transformer should be used, and if necessary, the telephones rewound with No. 36 S.S.C. copper wire.

"H.W.E." (Charlton).—It is not correct to state the length of the lead in should be as short as possible. The lead in should be as direct as possible, and if the wire for the aerial runs straight

"J.S.H." (Manchester) submits a diagram for criticism.

The circuit submitted is not very suitable, and it is doubtful whether it would function at all. We suggest you adhere to the original arrangement. The coils L_2 and L_4 should not be coupled to any extent, and you should determine by experiment their best positions.

"REBOS" (Hull) asks (1) For a diagram of a H.F. valve and crystal detector combination. (2) The values of the components. (3) What stations will be heard.

(1) The circuit given in reply to a correspondent in a recent issue will suit your purpose very well. (2) The values are marked in the figure. (3) You will probably hear telephony transmissions, ship stations, and high power transmissions.

"OMEGA" (Hants.).—A suitable transformer for your purpose would consist of an iron wire core 3" long and ½" diameter, with a primary winding of 250 turns of No. 22 S.S.C. The secondary could consist of 12,000 turns of No. 44 S.S.C.

Convince yourself

on the quality and supreme merits of the

MAGNAVOX

The World's Finest Loud Speaker

by paying a visit to our showrooms and hearing its voice. Demonstrations given daily. See our exclusive and extensive range of radio apparatus.

To be obtained from all dealers or direct from the Manufacturers & Sole Licensees

Sterling Telephone & Electric Co., Ltd.

210/212, Tottenham Court Road, London, W.1

Telephone No. : 4144 Museum (7 lines) Telegrams : "Cucumis, Wesdo, London."

Works : DAGENHAM, ESSEX.

BRANCHES : NEWCASTLE-ON-TYNE : 9, Clavering Place.
CARDIFF : 8, Park Place.

We guarantee that all Broadcast Radio Apparatus sold by us conforms with the conditions of the Broadcaster's Licence issued by the Postmaster-General.



No. R1282

RADIO brings it.
MAGNAVOX tells it.

YOUR WIRELESS SET IS ONLY AS EFFICIENT
AS YOUR BATTERY IS RELIABLE,
THEREFORE ALWAYS USE

HART BATTERIES

SUITABLE FOR
HIGH AND LOW TENSION CIRCUITS.

IMMEDIATE DESPATCH FROM STOCK OF FOLLOWING TYPES:—

TYPE	Voltage	AMPERE HOUR CAPACITY		APPROXIMATE OVERALL DIMENSIONS			TYPE OF BOX	NET PRICE EACH	
		Contin-uous	Inter-mittent	WIDTH	LENGTH	HEIGHT		Cash with Order.	Carriage Paid
P.L. 3	2	1	2	27/32"	2 8/8"	3"	CELLULOID	3s. 0d.	2s. 6d.
"	2	1	2	1 5/32"	2 11/16"	3 3/4"	EBONITE	6s. 0d.	5s. 8d.
"	2	1	2	1 1/2"	1 1/2"	4 1/2"	GLASS	5s. 3d.	5s. 0d.
E 5	2	5	10	1 1/2"	1 1/2"	6"	GLASS	6s. 9d.	6s. 3d.
A.P. 7	2	11	22	1 1/2"	1 1/2"	6 1/2"	EBONITE	6s. 0d.	5s. 9d.

THESE CELLS CAN BE SUPPLIED MADE UP IN BATTERIES OF ANY REQUIRED VOLTAGE. SPECIAL PRICES FOR SUCH BATTERIES WILL BE QUOTED ON APPLICATION.

HART ACCUMULATOR CO., LTD. STRATFORD, LONDON, E.15

BRANCHES:

BELFAST 41, CHICHESTER STREET	GLASGOW 107, WELLINGTON STREET
BIRMINGHAM 174, CORPORATION STREET	LONDON 36, VICTORIA STREET, S.W.1
BRISTOL 37, VICTORIA STREET	MANCHESTER 4, VICTORIA BRIDGE

YORK—6, BRIDGE STREET

The "BROWN" Loud Speakers

With New Improved Curved Horns

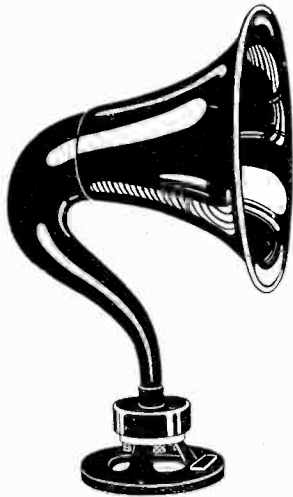

Visit Our
London
Showrooms:
19, Mortimer
Street, W.1

H.2 (small size), Height 12"

OUR MANUFACTURES ARE
OBTAINABLE FROM
ALL WIRELESS DEALERS

THE REQUISITES of a Loud Speaker are pure tone, clear articulation, and good volume of sound. The "BROWN" Loud Speaker possesses these qualities and they are enhanced by the new improved curved horn.

AMATEURS do not always need the full sized Loud Speaker (H.1) as used in Lecture Halls, and a small type (H.2) has been designed to meet their more modest home requirements both as to volume of sound and price.

THE NEW HORN of dull blacked aluminium used with both H.1 and H.2 is constructed on the logarithmic law of increasing openings and is acoustically perfect.

PRICES :

H.1 (Large) Low Resistance,
120 ohms, height 21" £6 5 0

H.2 (Small) Low Resistance,
120 ohms, height 12" £3 0 0

(High Resistances for either
size - - 2/6 to 5/- extra)

CATALOGUE POST FREE

THE "BROWN" MICROPHONE AMPLIFIER

THIS AMPLIFIER magnifies signals, speech, or music, without distortion, and is of considerable interest to amateurs and scientific investigators. This magnification is much greater than that obtained from a two-valve amplifier. In construction, this instrument

is much more robust than other relays. This instrument satisfies the urgent demand for a reliable, inexpensive amplifier, which the most inexperienced amateur can use, and which the most experienced requires. The necessary transformers are included in the base.

PRICES : Low Resistance (120 ohms input) £6 0 0
High Resistance (2,000 ohms) input 6 2 6

Illustrated Catalogue of our Headphones, Loud Speakers and Amplifier post free from—

S. G. BROWN, Ltd.

London Offices
and Showrooms

19, MORTIMER ST., LONDON, W.1

TRADE COMMUNICATIONS ONLY TO :—
HEAD OFFICE AND WORKS: VICTORIA ROAD, NORTH ACTON, LONDON, W.3
Telegrams—"Lidbrownix, London." Telephone—Chiswick 1469.
Sole Agent for the Argentine—Horacio D. Guerrero, Las Heras, 2486, Buenos Aires.

"D.A." (Hampton).—We suggest you examine the set for loose connections, and make certain the grid leak is quite good. We assume the H.T. battery is not run down.

"J.R.S." (Keighley) submits a diagram and asks (1) Whether the anode coils should be changeable (2) Whether the reaction coil should be coupled with the anode coil of the H.F. valve. (3) How to connect switches.

(1) The proposed arrangement is quite suitable. The anode coils are tuned with a variable condenser of maximum value 0.0002 mfd., and you will therefore require a set of coils if you wish to cover a wide range of wavelengths. The two anode coils should be of the same value, since then the condenser settings will be similar when receiving signals. (2) As you suggest, the reaction coil should be coupled with the anode circuit of the H.F. valve. (3) The switching arrangements shown in recent issues can be directly applied to your set

"A.L.W." (Sheffield).—It is not necessary to use a secondary circuit if you prefer to reduce the circuit adjustments at the expense of a little loss of selectivity. It is a matter upon which you can please yourself, in so far that the holder of an experimenter's licence is assumed to have sufficient knowledge of wireless to be able to control the degree of reaction himself, and not to set up

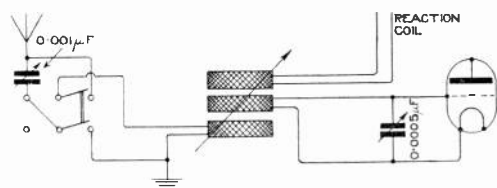

Fig. 3.

oscillations in the aerial circuit. The reaction coil, when coupled to the secondary circuit, is capable of setting up oscillations in the aerial circuit with an amplitude as great as when the reaction coil and aerial coil are coupled. However, the gain in selectivity is worth while, and the connections are made as indicated in Fig. 3. The proposed lay-out is quite suitable, and the addition of the third coil does not make any difference to the circuit apart from the change indicated in (1).

"A.M." (Colchester) asks (1) Will overhead tram wires, running parallel to his aerial, affect reception. (2) If it is possible to amplify The Hague concerts sufficiently with five-valves to operate a loud speaker. (3) Will a 100' single wire aerial be better. (4) Is a water-pipe earth good.

(1) and (3) We suggest you run the aerial wires at right angles to the tram lines, if possible, and as far away as it is convenient. A single wire aerial will probably give results superior to a double wire aerial. To reduce the noises, we think you had better reduce the number of L.F. connected valves and use H.F. instead. (2) We think five valves will provide sufficient amplification to operate a loud speaker. (4) Yes, if care is taken to make the connection good.

"PUZZLED" (Burton-on-Trent) asks for criticism of his set, particulars of which are submitted.

The connections are not quite correct, unfortunately. The reaction coil should be connected between the anode and L.F. transformer instead of between H.T.+ and L.F. transformer, and it would be better to disconnect the second valve entirely when the telephones are connected to the first valve. In any case signals will not be very satisfactory when one valve is used, because it cannot be expected that a transformer built to work between the output and input circuit of valves will work equally well between the output of the valve and the telephones. The transformers are not wound properly. We suggest you rewind them, using 10,000 turns of No. 44 S.S.C. wire for the primary, and 15,000 turns of No. 46 S.S.C. wire for the secondary. The telephone transformers may consist of 10,000 turns of No. 44 S.S.C. for the primary, and 2,000 turns of No. 36 S.S.C. for the secondary. With these alterations the signal strength will be greatly improved. The tappings from the H.F. transformers may be taken out to a switch, and it is convenient to leave small sections unwound at the tapping points in the case of cylindrical coils.

"A.H.S." (Southsea) submits particulars of his receiver and asks for criticism.

The wires enclosed are: (A) No. 29 S.S.C.; (B) No. 26 S.S.C.; (C) No. 36 S.S.C. The aerial and closed circuit tuning arrangements appear to be correct and should be satisfactory, although it is often better to make the filament connection to L.T.—instead of L.T.+ . Until telephony is actually heard, we suggest you connect wire A to the H.T.+ instead of to the slider. The anode circuit tuning will still be quite critical, but the adjustment will be less difficult. Reaction effects do not greatly help when receiving telephony transmission from commercial stations. We do not think you have sufficient wire in the L.F. transformer. To obtain good results, it is necessary to use a large number of turns of fine wire, otherwise amplification and the quality of speech suffer. We suggest you rewind the primary with 8,000 turns of No. 44 S.S.C. copper wire, and the secondary with 16,000 turns of No. 46 S.S.C. copper wire. If you find it inconvenient to count turns, we suggest you wind $\frac{1}{3}$ the winding depth for the primary, and the remaining $\frac{2}{3}$ for the secondary. It is often an advantage to use lower volts on the anode of the detector valve.

"PUP" (Gorleston) asks (1) For criticism of set. (2) How to tune out a local high-power transmitting station. (3) How to secure fine tuning in the anode circuit of the valve.

(1) The diagram submitted is correct. (2) We suggest you employ a secondary circuit consisting of a coil and condenser. The coil should consist of a winding of No. 28 D.S.C. on a former $3\frac{1}{2}$ " diameter, 7" long with 7 tappings. The tuning condenser may have a maximum value of 0.0005 mfd. (3) We suggest you join a three-plate condenser across the aerial condenser for fine tuning, and connect another with small plates across the 0.0002 mfd. condenser in the H.F. transformer circuit. Extension handles will probably have to be fitted.



MARCONI
GIVES
UNRIVALLED
WIRELESS
SERVICE

The MARCONI INTERNATIONAL
MARINE COMMUNICATION CO. LTD.
MARCONI HOUSE, STRAND, LONDON.

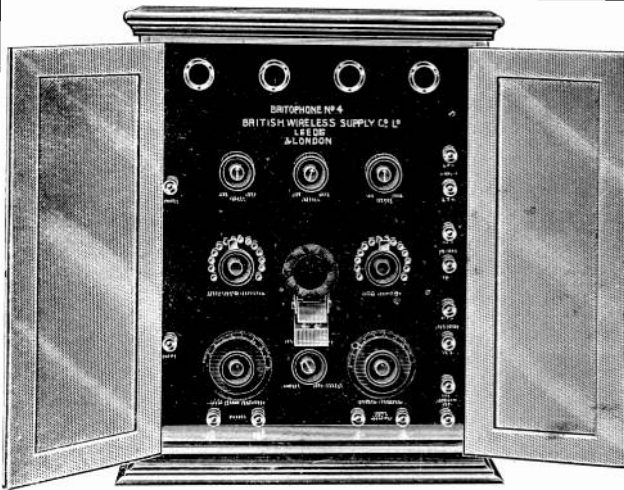

“BRITPHONE” No. 4.

Cabinet measurements, 20½" × 16½" × 9½". Range covers, 200-25,000 metres wavelength.

An excellent four-valve Broadcast Receiver in polished mahogany cabinet, with folding panelled doors fully in keeping with the general appearance of the instrument. The receiving panel is of Radion Mahoganite.

The four valves include 1 H.F., 1 Rect., and 2 L.F. steps. The last valve by means of a switch acts as either an ordinary magnifier or a power valve for use with any loud speaker. The high tension voltage on this valve can be anything up to 400 volts, thereby obtaining tremendous increase in volume of sound, suitable for entertainments in large halls or out in the open.

PRICE, complete with all accessories, including four Valves and Coils up to 4,000 metres,

40 GUINEAS

P.O. Regd. No. or81.

All "Britphone" Apparatus is approved by the Postmaster-General and is manufactured under Marconi licence.

BRITISH WIRELESS SUPPLY CO., LTD.

HEAD OFFICE 6, BLENHEIM TERRACE, LEEDS. Phone—26926.

LONDON SHOWROOMS: 64, FRITH STREET, W. (off Shaftesbury Avenue). Phone—Gerrard 2789.

DEMONSTRATIONS DAILY.

And at 18, Eldon Square, Newcastle.

Phone—Newcastle-on-Tyne, 360 City.

33, High Street, Southampton.

Phone, Southampton 403.

11, Church Street, West Hartlepool.

Phone—West Hartlepool, 373.

8, Corporation Street, Belfast.

Exide

BATTERIES

THE suitability of Exide Batteries for wireless work is demonstrated by the fact that for many years they have been standard in Marconi equipment. The leading apparatus manufacturers are to-day standardising Exide Batteries.



6 volt 80 amp. hour Exide Battery.

THE resources of the world's largest battery manufacturers, their facilities for research and modern factory equipment mean that were it possible to effect any improvement in battery design or construction, that improvement would appear in the Exide Pattery.

THE **Chloride** ELECTRICAL STORAGE COMPANY LIMITED.

CLIFTON JUNCTION,
Nr. MANCHESTER.

219/229, SHAFESBURY
AVENUE, W.C.2.

58, DALE END,
BIRMINGHAM.

OBTAINABLE FROM ELECTRICAL CONTRACTORS & STORES OR FROM

300 EXIDE BATTERY SERVICE AGENTS DISPLAYING THIS SIGN.



IF YOU DON'T KNOW YOUR NEAREST EXIDE AGENT ASK US FOR LIST.

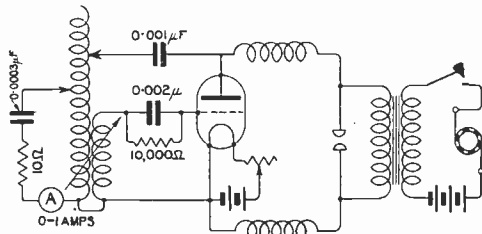

Fig. 6.

"S.W.B." (Manchester).—The artificial aerial may consist simply of a condenser, resistance, and the tuning inductance. No other inductance is required. The resistance could be 10 ohms, which is a fair estimate of the average resistance of an amateur transmitting aerial, and could consist of 10 yards of No. 22 Eureka wire. The capacity may be a 0.0003 mfd. condenser capable of withstanding 2,000 volts, and able to carry about 1 ampere without excessive heating. The diagram given in Fig. 6 indicates a good transmitter scheme. Values are marked in, and it should be remembered the condensers should all be built to withstand the sudden application of high potentials. We do not expect your transmissions would be heard at more than a few hundred yards, and this would appear to be the object of the Post Office in restricting the use of the set to a dummy antenna. The best adjustment of the interrupter brushes is that which gives least sparking, and for this purpose one of the brushes should be movable. The interrupter circuit will probably carry a heavy current, and large capacity accumulators should be used. If the insulation between the primary and secondary of the transformer is good, and the cells are insulated from earth, the filament potential may be tapped off the battery supplying this primary circuit.

"S.F.W." (Berwickshire) asks (1) *How many valves he will require to receive the Dutch concerts and Transatlantic stations.* (2) *What should be the maximum price of the set.* (3) *Whether more than two stages of H.F. amplification are difficult to handle.*

(1) We suggest you make up a three-valve set, using one high frequency detector and one note magnifying valve. The method of coupling the high frequency valve with the detector is known as the reactance capacity method. The anode circuit of the high frequency valve should be in proportion, so that it can be tuned over the same range of wavelengths as the aerial circuit. We refer you to Fig. 2, page 145, October 28th issue. (2) Until one has experience, the manipulation of two high frequency valves is something of a difficulty, but as the above circuit only makes use of one, we think you will experience no trouble. (3) We think you will have no difficulty in estimating the cost of the set yourself after a study of the advertisements in this journal.

"MELLT" (Carnarvonshire) asks (1) *How many basket coils to use in a H.F. transformer to tune up to 2,000 metres.* (2) *Whether basket coils may be used as reaction coils.* (3) *The dimensions of L.F. intervalve transformer.*

(1) We suggest you wind say six basket coils, each coil consisting of 40 turns of No. 38 S.S.C.

copper wire with a mean diameter of 3". The primary should be tuned with a variable condenser of maximum value 0.0002 mfd. (2) Basket coils may be used as a reaction coil, 60 turns of No. 38 S.S.C. wound on a former with a mean diameter of 3" being suitable. (3) The construction of a L.F. intervalve transformer was fully described in the issue of August 19th. Use the No. 42 S.S.C. wire for this purpose.

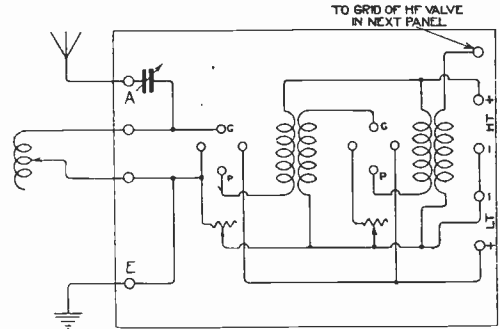

Fig. 7.

"EBONITE" (Southampton) asks (1) *For a diagram of a panel incorporating 2 H.F. connected valves.* (2) *Why he does not hear broadcast telephony transmissions.*

(1) See Fig. 7. You will require two small variable condensers as illustrated in the figure. (2) We think you should hear the transmissions with your present arrangement, and we suggest your tuning arrangements do not permit you to tune down to the wavelength. The A.T.C. and A.T.I. should be connected in series, and you should use a small tuning coil. A winding of No. 22 D.C.C. on a former 4" in diameter and 4" long with 6 tappings would be suitable. The construction of a H.F. transformer which is suitable for short wavelengths, is given in the issues of September 2nd and 16th, under "Experimental Station Design."

SHARE MARKET REPORT

Prices as we go to press on December 21st, are:—

Marconi Ordinary	£2 4 4½
.. Preference	2 0 0
.. Debentures	102 5 0
.. Inter. Marine	1 5 7½
.. Canadian	9 4½
Radio Corporation of America:—		
.. Ordinary	15 10½
.. Preference	13 3

MARCONI INTERNATIONAL MARINE DIVIDEND.

The Marconi International Marine Communication Company, Limited, announce an interim dividend of 5 per cent. less income tax upon the issued capital of the Company. This dividend will be payable on January 8th, 1923, to shareholders registered on December 19th, 1922, and to holders of Share Warrants to Bearer. The Transfer Books will be closed from December 20th to December 26th, 1922, inclusive.

ORA

The Valve for perfect reception

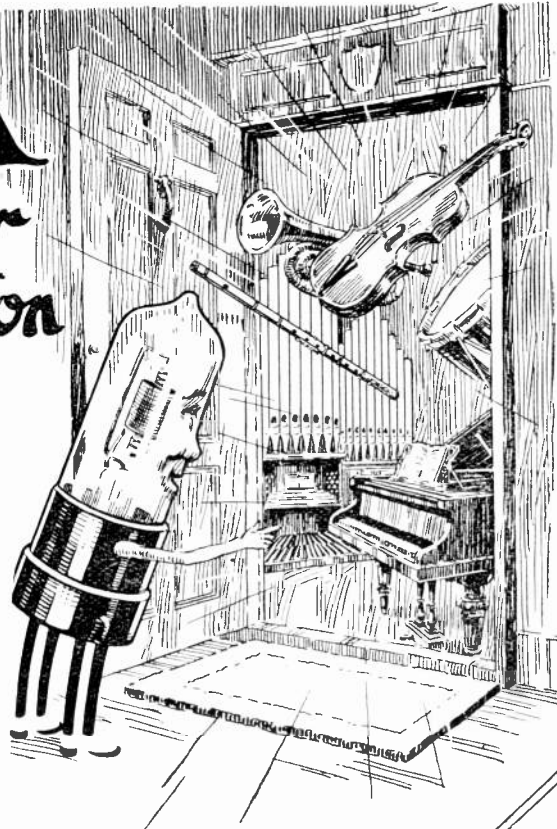

Mr. "ORA" wishes his many friends and supporters a Very Prosperous New Year.

He looks forward to spending many delightful hours in their company during the festive season.

For receiving vocal and instrumental items you must have the

Mullard "Ora" Valves to get the best results.

Oscillates — Rectifies — Amplifies
Specially recommended where good amplification is required.

The "Ora" Valve requires about 3·8 volts on the filament and 30 volts or over between the anode and filament for efficient results.

15/- each

The MULLARD "R" VALVE is now reduced in price from 22/6 to 17/6.

Mullard Radio Valve Co., Ltd

45, Nightingale Lane, Balham, S.W.12.

Contractors to H.M. Admiralty,
War Office, Royal Air Force &
Post Office.

Telephone: Codes: Telegrams:
Battersea ABC (5th Ed.) "Radiovalve,
1068. Bentley's Wandsworth Lond."



Name and Address
To the
MULLARD RADIO
Valve Co. Ltd,
45, Nightingale Lane,
Balham,
S.W.12.

Please send me post free—

Quantity Description
..... Telephone Head Sets
..... ORA Valves
..... Grid A Resistances
..... Anode A or B Resistances
..... B A Condensers 0015 mid
..... Combined Resistance and Condenser
..... Valve Bases with Terminals
..... Valve Sockets
..... Terminal Clips
Name of usual Wireless dealer:

Price
Type A 21/6
Type B 25/6
Type C 27/6
Type D 21/6
Type E 17/6
Type F 15/6
Type G 13/6
Type H 9d. per pair

I enclose (Cheques,
Money Order, P.O.) Value
to cover the
cost.

SEND THIS
TO-DAY.

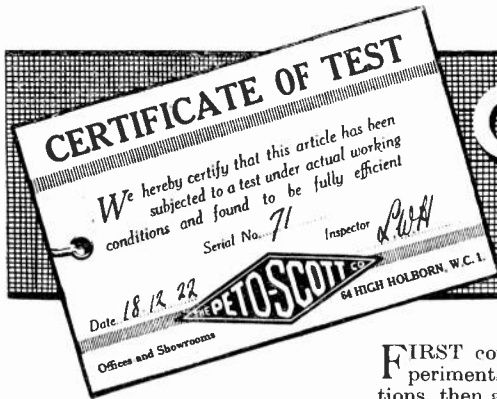

Guaranteed AMPLIFIERS

The reliable
MAX-AMP
L.F. TRANSFORMER

The finest possible construction. Secondary and primary windings heavily insulated and tested on 500 volts between windings. Stalloy core, secondary winding protected by stout cord outer winding. Strong brackets permit easy mounting.

21/-

Tested on actual Aerial and fully guaranteed.

FIRST come painstaking experiments, laboratory calculations, then a careful selection of materials, and finally the "right away" for quantity production.

But even there the Peto-Scott idea of Service does not end. No MAX-AMP or MULTI-VALVE is sold unless it has successfully passed critical Aerial tests.

We consider it our duty to you to see that every single Radio component we sell and manufacture passes our high standard. By such methods alone has the Peto-Scott Company fought its way—step by step—to its proud position among the leaders of the Radio Industry.

The well-proved
Multi-Wave
H.F. AMPLIFIER

For all wavelengths above 1,000 metres. Simply plug in—no variable condenser needed. In solid ebonite in two styles—No. 1 for use with one H.F. Valve, and No. 2 for more than one stage of H.F. amp. (In this case No. 2 is used between first and second valves, and No. 1 before detector.)

No. 1, for use with one H.F. Valve .. **8/6** No. 2, for more than one H.F. Valve .. **12/6**

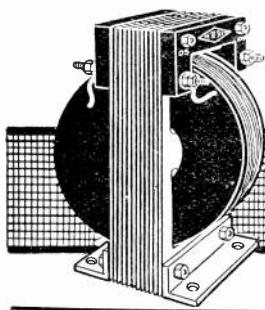

THE PETO-SCOTT Co.
64, HIGH HOLBORN, W.C. 1

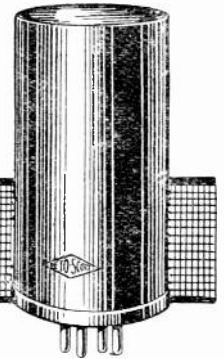

MARSHALL AD.

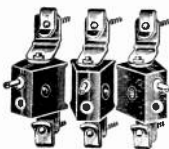

Independent Type.

RADCOM TRIPLUG TUNERS

Consisting of three separate units for Panel Mounting, complete with spring clip terminals

Price 8/6

Extension Handles, extra per pair 1/6

Triplug units assembled on base, ready for Panel Mounting, complete with spring clip terminals

Price 16/-

Extension Handles, extra per pair 1/6

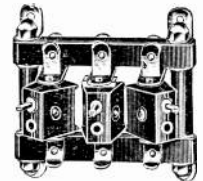

Assembled Type.

RADCOM RHEOSTATS, TRANSFORMERS, BATTERIES.

Write for Catalogue.

Radio
COMPONENTS LTD.

12/13, HENRIETTA STREET,
LONDON, W.C.2.

'Grams: Radponents, Rand, London. 'Phone: Gerrard 792 E.P.S.

ACCUMULATORS

4 volt 40 amp 18/6 4 volt 100 amp 30/-
 6 volt 40 amp 26/3 6 volt 100 amp 43/6
 In Celluloid Cases. All sizes quoted for. Large stock held.

SPECIAL LINES.

6 volt 40 ACTUAL amp full, in three Glass Cells, sealed tops and in well-made Teak Crate, 11 plates per cell, 49/6.

6 volt 20 amp, in Celluloid, 19/- each.

FILAMENT RESISTANCE.

Beautifully made, 3/- each. Best value on market.
 Headphones, 4000 ohms, 22/6 pair.

ALL SUBJECT TO GOOD TRADE DISCOUNT.
 WRITE FOR OUR LIST—IT WILL PAY YOU.

F. YATES & SON, LTD.

WHOLESALE ELECTRICIANS,

144 Church St., Kensington, London, W.8

Phone: Park 4276. One minute from Notting Hill Gate.

GENTS' "DISCOL" H.F. TRANSFORMER

HAS
 BECOME



A
**STANDARD
 FITTING**

We will send literature on receipt of p.c.

in the RADIO WORLD and is in large demand by every class of user.

Ask your Dealer for Gents' "Discol" H.F. Transformer

6/8 each

Also Gents' Tangent L.F. Transformer, 22/6 each.

GENT & CO., LTD. Radio Dept., Faraday Wks., **LEICESTER**

London: 25, Victoria Street, S.W.1.
 Newcastle-on-Tyne: "Tangent House," Blackett Street.

Ediswan Valves

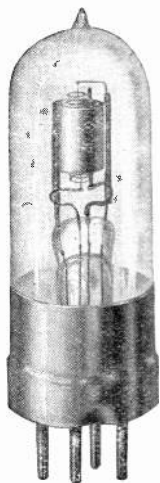

have over forty years' of lamp making experience embodied in their manufacture. The AR Valve illustrated is specially made for amateur reception.

Plate voltage 30-80. Filament volts 3.5-6.0. Filament current 0.75 amperes. High amplification. Silent working.

15/- each

THE EDISON SWAN ELECTRIC Co., Ltd.

Head Office: 123/5 Queen Victoria Street, E.C.4

London Showrooms: 123/5, QUEEN VICTORIA ST., E.C.4
 71, VICTORIA ST., S.W.1

Works: PONDERS END, MIDDLESEX

BRANCHES:—

Aberdeen	Bristol	Edinburgh	Leicester	Nottingham
Belfast	Cardiff	Glasgow	Liverpool	Sheffield
Birmingham	Dublin	Hull	Manchester	Southampton
Brighton	Dundee	Leeds	Newcastle	Swansea
Melbourne	Brisbane	Sydney	Adelaide	

If you are unable to obtain Ediswan supplies from your usual dealer, write to us for the name and address of the nearest supplier.

EDISWAN BATTERIES H.T. and L.T.

are all manufactured with the same care and attention to details as other Ediswan products. Always insist on "Ediswan" when purchasing Accumulators or Dry Batteries.

CAPPER BROS.

FOR ALL RADIO REQUISITES

We are the official agents for WOKING and DISTRICT of **LESLIE McMICHAEL, LTD.**, the well-known manufactures of wireless equipment, and can supply all their high grade sets and accessories *at once.*

89-93, CHERTSEY RD., WOKING

FOR WIRELESS INSULATION

USE
"BAKELITE"
 (Trade "FORMITE" Mark.)
 Insulating Materials

Sole Manufacturers
THE DAMARD LACQUER CO., LTD.,
 WARWICK ROAD, GREET, BIRMINGHAM.

No Waiting. Delivery from Stock



Perry Head Phones
 4,000 Ohms **21/-** per pair

Specially designed for Wireless Telephony. Receivers arranged in series, Aluminium Cases and fitted with extremely light and efficient Head Bands, and Twin Connecting Cords.
Illustrated Wireless Catalogue now ready, post free 3d.

The JEARY Electrical Co., Ltd.
 8, LAMBETH HILL & 97, Queen Victoria St., London. E.C.4

WIRELESS TRAINING

Most thorough training in Wireless Telegraphy or Telephony given under ideal conditions.

Special Postal Course for Amateurs.
Prospectus Free.

WIRELESS APPARATUS

Complete stocks of all Wireless Instruments and Accessories. Prompt Deliveries. List 1½d. stamp.

WIRELESS COLLEGE COLWYN BAY



**Can I help you?
 I WILL GIVE YOU £50**

If I fail to produce over 7,000 testimonials from others I have helped to **A SUCCESSFUL CAREER**

Yours to success,

Every man is the Architect of his own Fortune!
**ARE YOU QUALIFIED?
 FOR THE JOB YOU SEEK?**

WE TEACH BY POST

ADVICE FREE.
 Most moderate charges.
PAYABLE MONTHLY.

LEARN A TRADE OR PROFESSION.

Write for one of our **FREE BOOKLETS** on any of the following subjects:

- Architectural Drawing
- Building Construction
- Clerk of Works' Duties
- Aviation
- Boiler Engineering
- Boiler Making
- Chemistry
- Civil Engineering
- Concrete and Steel
- Draughtsmanship
- Electricity
- Engineering
- Foundry Work
- Internal Comb. Engines
- Marine Engineering
- Mathematics

- Matriculation
- Metallurgy
- Mining
- Mine Surveying
- Motor Engineering
- Naval Architecture
- Pattern Making
- Salesmanship
- Sanitation
- Shipbuilding
- Structural Engineering
- Surveying and Levelling
- Telegraphy & Telephony
- Wireless Telegraphy
- Special Course for Apprentices

What proof do you carry? Your word to an employer is not proof that you are efficient, but a College Qualifying Diploma or Certificate, signed by the Professional Staff, is a proof of efficiency, and a valuable asset in seeking a remunerative position.
We specialise in all exams. connected with technical subjects. If you are preparing for any exam. ask our advice. All particulars **FREE OF CHARGE.** Parents should seek our advice for their sons. If you are interested in any of the subjects mentioned above write, naming the subject, and we will send you our **FREE BOOKLET**

Please state your age
Courses specially combined to meet all requirements.



PRESSLAND ELECTRIC SUPPLIES LIMITED.

Managing Director:
CLIFFORD PRESSLAND, A.M.I.E.E.,
 Hampton-on-Thames.

Wholesale only.

Our 1923 Radio Catalogue is now ready and will be sent on application to any *bona fide* Trader

LESLIE M^c MICHAEL^{LTD.}

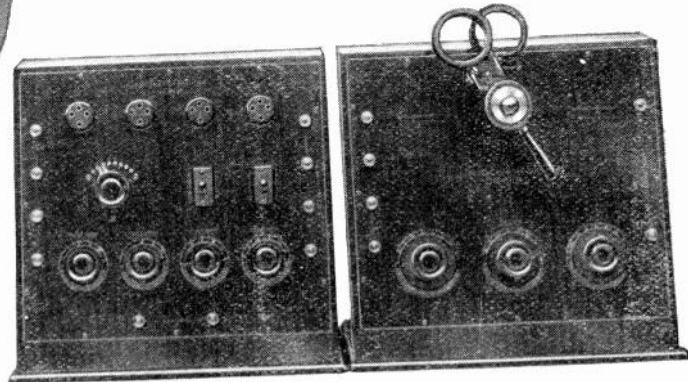

FOUR - VALVE DETECTOR AMPLIFIER

Accessories for Complete Station include the following:—

Tuning Coil Holder (for 3 coils); Tuning Coils, 150 to 3,000 metres; High Tension Battery; Low Tension Battery; Aerial, 100 ft.; Insulators (4); Headphones, 8,000 ohms (Brown's); 4 valves; 6 "Plug-in" Transformers, at a cost of about .. **£14**

LOUD SPEAKERS can also be used if desired. Prices from .. **£2 7s. 6d.** each

This instrument is designed for those who require perfection in finish and performance. The set is of highest grade finish, consisting of a 4-Valve Detector Amplifier fitted with a full range of controls, and being provided with selector switches by which 2, 3 or 4 valves can be used individually at will.

The strength of signals is such as to permit of an almost unlimited number of headphones to be used, or a Loud Speaker can be connected, thus making possible collective enjoyment of music, speech, etc.

PRICE £25 os. od.

A splendid Gift which will give great pleasure to all owners and their friends.
VISIT OUR SHOWROOMS. DEMONSTRATIONS DAILY.

NOTE.—The illustration shows Loud Speaker and Tuner Panel as well as our famous 4-Valve Detector Amplifier. Full details of other M.H. Sets, 1 to 3 valves, of similar design, and unsurpassed efficiency, are mentioned in detail in our NEW M.H. Booklet, 6d. Post Free. All applying for same will also receive our GENERAL CATALOGUE with 16 pages and 100 illustrations. (All our valve apparatus is manufactured under Marconi Licence).

London Showrooms :

179, STRAND (Corner of Norfolk St.), LONDON, W.C.2

Head Office (to which all correspondence should be sent) :

HASTINGS HOUSE, NORFOLK STREET, STRAND, LONDON, W.C.2



66 POLAR 99

BULLETIN of "RESULTS"

NEWCASTLE, 30/11/22.

1

"The 7-Valve Radiophone Set was duly fitted for Messrs. yesterday, and tests carried out last night.

"I beg to report that excellent results were obtained to our great satisfaction. Very strong reception was got from 2 L.O. and local telephony from a Newcastle Station, 5 BA. Good signals were received from Writtle, Birmingham and Manchester. Signals throughout from all stations were very clear and distinct without the slightest distortion. Everyone listening remarked on the perfect tuning and lack of interference from Commercial Stations. Cullercoats could hardly be heard, although using 5 k.w., a few miles away. He was not strong enough to interfere with the weakest telephony."

The above results refer, entirely to the loud speaker, the telephones being used for tuning in.

GLASGOW, 12/12/22.

2

"I am pleased to say, that the R.A. 33, 34 and 35 Combination, supplied through Messrs. to Mr. has been installed, and was tested by myself personally, last night. Reception from 2 L.C., which was too strong for the head telephones, was comfortable over a large-sized room, through the medium of a gramophone adaptor, and a hornless H.M.V. machine. Manchester was particularly clear, and Mr. has expressed his surprise and appreciation of the excellent results achieved, which were far beyond his expectations."

I myself, am particularly pleased with the results, as this is the first set which has been actually tested in this district, and considerable doubt had been expressed locally, as to its capability of receiving London through this heavily screened area."

BOLTON, 9/12/22.

3

"We beg to thank you for the early delivery of the three R.A. 36 Condensers, Credit Note and Lists. These "Polar" Condensers are undoubtedly the finest we have come across yet, and we have been handling wireless material for a matter of twelve years or so.

"They are a credit to your designers.
We enclose a further order herewith.

"Yours faithfully,

"P.S.—You are at liberty to use this order as a testimonial at any time if so desired."

AND THE "HOW" OF IT.

Nos. 1 and 2 refer to the "POLAR" Radiophone Unit Combination R.A. 33, 34 and 35, containing double circuit tuner, three-stage H.F. detector and three-stage L.F. amplification. PRICE, WITHOUT ACCESSORIES .. £47 11s. 6d. This set has absolutely no equal for broadcasting reception over long ranges.

No 3 refers to the now famous "POLAR" Variable Condenser, Panel Mounting Type, R.A.36. This condenser is now available in three ranges—
0001 to 0003 mfd.
0001 to 0005 mfd.
0001 to 001 mfd.

Chosen
for
Good

PRICE 14/9 POST FREE for Panel Mounting.
20/9 " " in Polished Wood Case,

THE

RADIO COMMUNICATION CO. LTD

(Suppliers of the G.P.O. Installations at North Foreland (G.N.F.) and Seaforth (G.L.V.), of Coastal Stations for various Colonial Governments, and of Ship's Radio for most of the Great Shipping Companies.)

34/35, NORFOLK STREET, LONDON, W.C.2

BRANCHES—NEWCASTLE—17 Sandhill. GLASGOW—116 Hope Street. LIVERPOOL—67 Dale Street.
CARDIFF—Atlas Chambers, James Street. SOUTHAMPTON, 19, Queen's Terrace.

Components



*Every Article
made by
Auckland's
is in a Class
by Itself.*

- Series Parallel Switches 4/6
- Table Coil Holder 3 way 18/-
- " " " 2 " 15/-
- Fil. Resistances 3/9
- Interval Transformers 20/-
- Igranic (Auckland)
Coils from 5/-

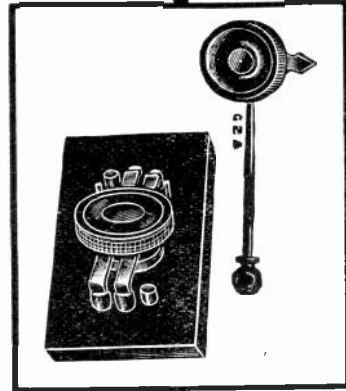

CATALOGUE FREE

- Telephone Transformers 13/6
- " " Mtd. 17/6
- Extended Knobs and
Pointer 1/6
- Condenser Dials and
Knob 3/9
- Coil Plugs 1/6
- Fibre Strip 4' 6" . . . 1/-
- Uni Wave Slabs—Set.. 12/6
- Grid Leak and Con-
denser 4/6
- Pin Type H.F. Trans-
former for Broadcast 5/-

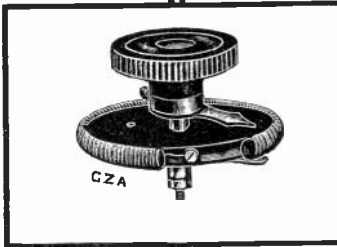
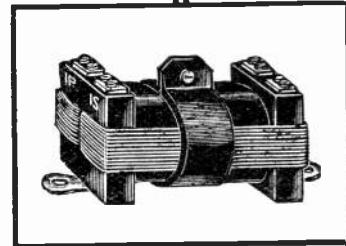

We carry stocks of all makes of H.T. Batteries, Phones and Valves, and supply from stock.

Why not make use of our World Wide Service? It will pay you, especially if you say

*“Auckland
Products”*

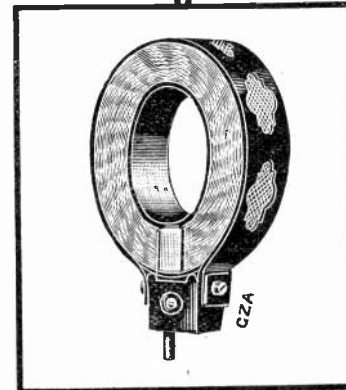
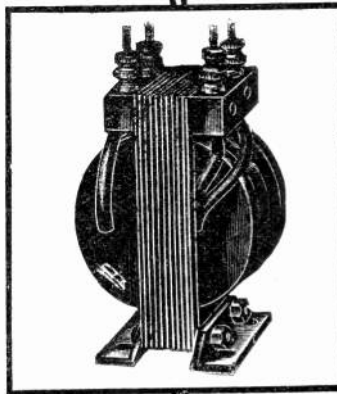

G. Z. AUCKLAND & SON,
Factories—ISLINGTON, N.

LONDON OFFICES :
395, St. John Street, E.C.1
Phone 3178 CLERKENWELL

WIRELESS INSTRUMENT MAKERS



T. E. C.



Patent
Spring
Conne-
ctions
are
specially
adaptable
for
Wireless
Work.

- PATENT -

SPRING CONNECTIONS

IN NUMEROUS SIZES & DESIGNS

<p>SIMPLE STRONG CHEAP EFFECTIVE</p>		<p>LARGE STOCKS PROMPT DESPATCH</p>
--	---	---

The EFANDEM CO. LTD

PHONE 1123 · FALLINGS PARK WORKS · TELEGRAMS "EFANDEM"
WOLVERHAMPTON

Ask for Samples and Illustrated Price List.

Patent
Spring
Conne-
ctions
are
specially
adaptable
for
Wireless
Work.

WIRELESS

Component Parts for Wireless a Speciality

:: :: Complete Cabinet Crystal Sets :: ::

:: :: Build Your Set by Degrees :: ::

All Suitable Tools and Materials in Stock

:: Complete Folding Work Benches ::

RICHARD MELHUISS LTD.

Tool, Machine & Hardware Merchants, Electrical Engineers
50, 51 & 84, Fetter Lane, E.C.4

Telephone : 1611 (3 lines) Holborn. Established 1828. Telegrams : "Workfolk, London."

Awards for Excellence of Tools and Machines:
Bronze Medal 1884. Gold Medal 1890.



Series No. 6



The Wireless Receiving Cabinet de Luxe (Model No. 1)

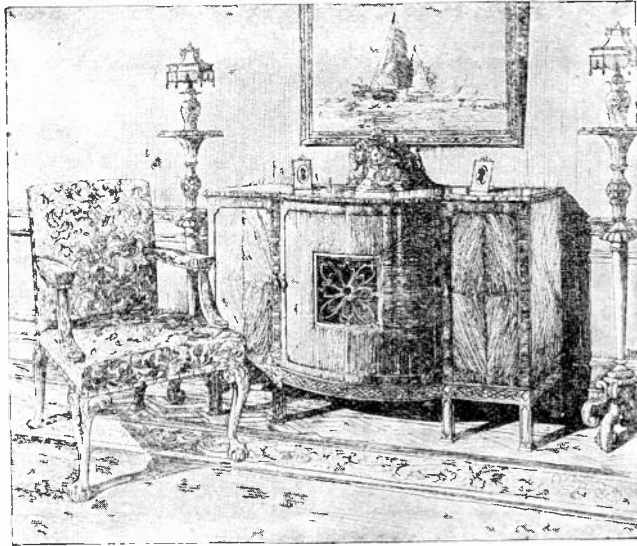

With gradual education of the public to the possibilities of wireless in the home, these exquisitely constructed Western Electric Receiving Cabinets should provide a very considerable source of new business and profit to the Wireless dealer. In any period design to harmonise with any scheme

of decoration, these sets appeal very strongly to the householder of taste. The cabinet contains complete equipment for the reception of wireless broadcasting, and has a range of at least 200 miles. No earth connection whatever is necessary. Simple, elegant and efficient —Western Electric quality throughout.

Western Electric

Makers of over Half
the World's Telephones.

Connaught House, Aldwych, W.C.2
Telephone—Central 7346.

WORKS:—

North Woolwich, London, E.16
Telephone—East 3840 (10 lines)

Also at BEXLEYHEATH, KENT, and NEW SOUTHGATE, N.11

Birmingham—Grenville Buildings, 12, Cherry St.
Leeds—Standard Buildings, City Square.
Cardiff—Motor House Chambers, 1, Wood St.

Manchester—Northern Assurance Buildings.
Newcastle—20, Saville Row.
Glasgow—49, West Campbell Street.

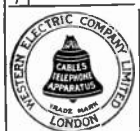

"RADIO - WAVE" CONCERT RECEIVERS. TWO-VALVE RECEIVER; BROADCAST RANGE 100 MILES.



PRICE: £16 : 16 : 0 with Valves.

Approved by the P.M.G. for Broadcast Reception.

THE "Radio-Wave One-Valve Receiver (Price : £10:10:0) meets the needs of those living within 50 miles of a Broadcasting Station. For those living at greater distances there are the Radio-Wave 2, 3, 4 and 5 Valve Sets. These are described in our catalogue which contains over 40 illustrations of wireless apparatus actually made in our works, sent free.

THE MEDICAL SUPPLY ASSOCIATION, LTD.

167/185, Gray's Inn Road, London, W.C.1.

Works: LONDON & SHEFFIELD.

Telephone: MUSEUM 7212 Ext. 3.

HOP
134

IMPORTANT.

HOP
134

WE HAVE OPENED VERY COMMODIOUS PREMISES AT

54 GRACECHURCH STREET, E.C.3

for the demonstration and sale of all types of Wireless Receiving Sets and "Claritone" Loud Speakers. Amateurs and Experimenters will be able to obtain every part required for any type of Set including:—

Transformers, L.F. and H.F. Headphones, all types, all resistances.
Condensers, Variable and Fixed, all capacities.
Vario-Couplers and Vareometers. Coil Holders and Coils.
Anti-Capacity Switches, all types.
Rheostats, all types.
Radial Switches, 5, 10 and 15-way.
Valves, M.O. and Mullards.
Ebonite Valve Holders, Dials, Scales, other parts and in Sheet.

Brass W.O. and Telephone type Terminals, Nuts, Washers, Contact Studs and all other parts.

Accumulators.

Dry Batteries.

Aerial Wire.

Insulators.

Hertzite and Galena Crystals.

Cotton and other Tubings, all colours.

Etc. etc.

PRICE LIST ON APPLICATION.

Pettigrew & Merriman, Ltd., 122-124 Tooley St., London, S.E.1

NOTE.—54, Gracechurch Street, is a few yards from Monument, Eastcheap, Bank, Cannon Street and London Bridge.

"We Reply by Return"

APPARATUS AT YOUR PRICE

The following are a few items from our lists and should interest you. Every article carries our money-back guarantee with it.

Filament Resistance Panel Mounting ..	2/6
Crystal Detector, Single Cup ..	2/9
Double Cup ..	3/6
Crystals, all kinds .. per packet	6d.
Wood's Metal .. per stick	8d.
Buzzers for testing Crystals ..	2/6
Inductance Sliders to fit 1/4" rod ..	9d.
Brass Rod, square, 1/4" x 1/4" .. per foot	6d.
Brass Rod, round, 1/4" ..	6d.
3/16" ..	5d.
1/8" ..	3d.
Strip Brass, 1/2" x 1/8" ..	6d.
Aerial Wire, 7/22s. stranded copper, per 100'	4/6
Insulators, Egg Pattern, .. each	3d.
Voltmeter, 0-5 volts ..	6/6

Postage extra on all above.
Send to-day for your copy of our FREE list.

Electrical Supply Stores,
5, Albert Terrace, King Cross, Halifax.

Bargains : Bargains

Brown's "A" Type Phones,
at much below Maker's Prices.

120 ohm - - -	40/-
8,000 .. - - -	42/6
Cords - - - extra	2/6

All goods seven days approval
against Cash with Order.

POST FREE.

FRANK TAYLOR,
Electrical and Wireless Engineer,
82 Market St., Milnsbridge, Huddersfield.

JUST OUT Wireless Handbook and Diary 1923

Edited by PAUL D. TYERS.

Contains more pages of wireless data than any other similar Diary.

PRICE 2/6 NET.

A complete Letts' Diary with 40 pages of valuable wireless information and the usual pages of useful general information.

Beautifully bound in leather, it forms an ideal gift.

Obtainable through all Booksellers or direct, post free 2/8½, from

Radio Press Ltd.
DEVEREUX COURT, TEMPLE,
LONDON, W.C.2

The "Autoveyors" 3-ELECTRODE VARIABLE CONDENSER

(British Patent 17703/22)

is the most efficient precision controller of oscillations in radio circuits. It comprises three sections, each consisting of a tier of parallel plates of one-third disc area. The centre section is spindled and knobbed, and permits a variation of capacity over 360 degs. Both side sections are spindled and knobbed and permit Vernier control of extreme precision. Thus, whilst providing all the essentials of the ordinary 2-Electrode Variable Condenser, it affords the added advantage of the coupling of the third electrode, which may be applied in a thousand and one ways.

In **Aerial Circuits** the 3-E.V.C. permits the application of capacity from Zero Series to Maximum Parallel by a single operation. Additional switches are unnecessary, and detuning from Series to Parallel is avoided.

In **Closed Circuits** it provides a precision-controlled static coupling for synchronous super-regeneration or relay radiation choke of unbounded possibilities.

In **Grid Circuits** it permits the employment of regenerative static influence upon the input.

In **A.ode Circuits** it affords definite control of by-pass, stability and regenerative applications.

In **Oscillator Circuits** the 3-E.V.C. ensures precision control of synchronism.

Full particulars from the Sole Patentees:—

AUTOVEYORS, LTD.
Radio Engineers and Contractors
84, Victoria Street, London, S.W.1
'Phone: Victoria 309.

MAST SERVICE

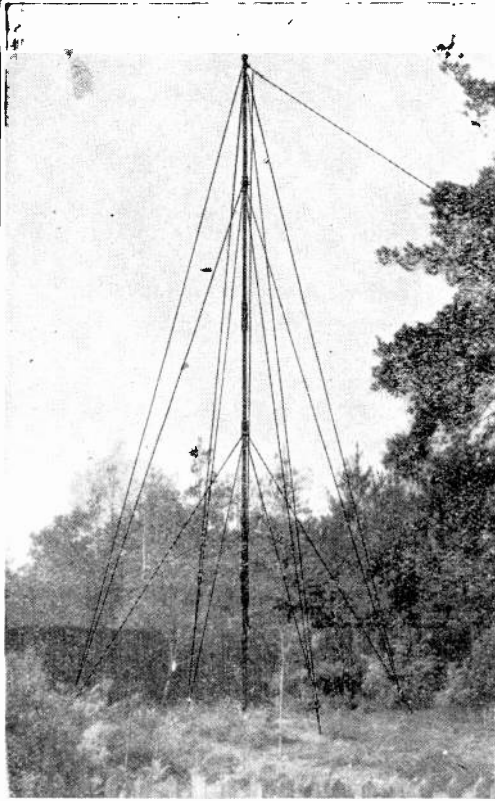

Made of best quality solid drawn steel tubes, to aircraft specification for strength and lightness. Designed for EASY ERECTION.

PRICES.

Complete in every way, ready for erection and Carriage Paid any railway station, England or Wales—

30 ft. 8 stays	40 ft. 8 stays	50 ft. 12 stays
£3 15 0	£4 10 0	£5 10 0

Carriage Paid, Scotland: Above Prices plus 6 per cent. Mast Completely Insulated (Type B) 21/- Extra.

Full specification sent on request, also for larger and smaller masts.

ERECTING GEAR.

Specially Designed Erecting Gear for use with these Masts loaned against 20/- deposit. With this gear a 50 ft. mast can be erected by one man in 4 hours.

TRADE ENQUIRIES INVITED.

Manufacturer—

H. LONGTON, A.M.I.Mech.E.
43, Johnson St., WESTMINSTER, S.W.1

WIRELESS PARTS

AND ACCESSORIES AT MANUFACTURERS' PRICES

ACCUMULATORS, 4 Volt 40 amp. 19/6
Aerial Wire, 100' drawn copper, 7/22's. 3/6
Aerial Wire, 100' drawn copper, 7/22's enamelled 5/10
CRYSTAL DETECTOR. New Design. Mounted on ebonite base, universal joint, ebonite handle, heavy brass terminals, without crystal. 3/4
Condenser Vanes, guaranteed accurate. doz. 9d.
Contact Studs doz. 1s., per gross 7/6
Brass Rod, Square, 13" 6d.
CABINET, 14½" × 12", for sloping panel, beautifully polished and finished each 19/-
Grid Leak, any capacity 1/8
Fixed Grid Condensers each 1/8
Switch Arms, with ebonite knob, best quality, with nuts and washers 2/-
Slider and Plunger doz. 7/6
Porcelain Insulators each 6d.
Terminals, solid brass, knurled, large, 2/- doz., 21/- gross
Terminals, solid brass, knurled, small, 1/5 doz., 15/- gross.
Please include enough for postage. Orders over 20/- carriage paid.

HANDY BENCH VICE. Specially suited for the Wireless Workshop, 2" jaw, all steel, Sheffield make. For a short period only. Carriage paid 6/11
Let us quote you for best quality Wireless Component of every description. Every article guaranteed, money returned if not satisfied.

Special terms to the Trade.

THE "ABROW" MOTOR CO.

WIRELESS DEPT.,

184 & 186, London Road, MANCHESTER.

Works: 73 & 75, Downing Street and Hague Street.
Phone—CENTRAL 6142.

BROADCASTING RECEPTION SETS

One-Valve Set, Complete for Working £7 10s.

Passed for
Broadcasting
Licence
G.P.O. No.
1038.

DESCRIPTION.

Single Valve, mounted on polished ½" Ebonite Panel with Variable Condenser, smooth acting resistance, grid leak and condenser and all terminals clearly engraved in white, in a Mahogany Polished Cabinet, 9" × 5" × 5" £3 15s.

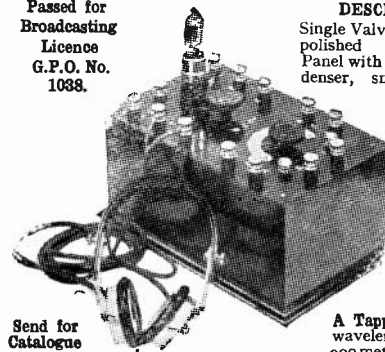

Send for
Catalogue

A Tapped Coil for wavelengths up to 900 metres with 2 terminals

for coils for any higher wavelengths. The coil is enclosed and theappings are brought out to an 8-way switch mounted in the front of the cabinet.

ACCESSORIES INCLUDED:

Siemens' 54 volt high-tension battery with plugs for altering the voltage 15s.
4 Volt 50 Amp. hour low tension accumulator in case with carrying strap £1 4s.
One pair of sensitive head 'phones of 4,000 ohms resistance £1 1s.
One detecting valve 15s.

Total £7 10s.

Satisfaction Guaranteed or money refunded.

WIRELESS INSTALLATIONS LTD.

15, ALDERSGATE STREET, LONDON, E.C.
Agents Wanted.

A FEW PRICES

Complete List Free on Application

- Polished Moulded Dial and Knob, engraved 0-100 complete with set screw 2/-
- Polished Moulded Valve Holders, Type A with Flange 6d.
- Moulded Valve Holders with screwed leg nuts and washers complete 1/-
- Polished Knobs with 2 B.A. nut inset 3½d.
- Ditto Superior with concave top 4d.
- L.F. Amplifiers, new Ex-Government stock for 3 Valves. These give excellent results with a crystal receiver and loud speaker £4/5/-
- Boxes, polished mahogany for ebonite panel, 8 15/16" × 5 15/16" × 4", internal depth 4 1/2". Panels for above in pure ebonite matt finished 2/-
- Panels, ebonite matt finish, 9" × 6" × 1/2" 2/-
- Panels, ebonite matt finish, 7" × 5" × 1/2" 1/6
- Panels, ebonite matt finish, 4 1/2" × 4 1/2" × 3/16" 8d.

Hundreds of other lines at proportionate prices.

Please send sufficient postage on small orders. Orders over 20/-, post and packing free in U.K. and Ireland.

H. V. ALBROW

56, George St., Baker St., London, W. 1
2 mins. to the rear of Selfridge's. Phone Mayfair 5842.

THE MARK OF RELIABILITY



Filament Resistances
2/-
EACH
Panel Type
and Pointer

Potentiometer
300 ohms
4/6
EACH
Panel Type on
Ebonite

1 to 12 Volts. 1 to 35 amps.

VOLT & AMMETER

Combined Dead Beat Pocket Type. New and not German. Splendid Instrument in Nickel Plated Case. Ideal for Testing Cells and Filament Current.

POST PAID **5/6** NUMBER LIMITED

OTHER EXCEPTIONAL VALUES

- Aerial Wire. Bright Hard Drawn, 7/22 Copper, 3/8 per 100'; same enamelled, 5/-.
- Aerial Insulators. 2 × 2 1/2". Shell type, 9d. each; 2" Reel Type, 2d. each.
- Telephone Transformers. (Army Type.) 9/- each; L.F. Transformers, 15/- each.
- Vernier Condenser. 5-Plate for Panel mounting, 4/- each. -001-58 Plate, 16/-.
- Wireless Jacks, with Plugs, 1/- the pair.
- High Note Buzzer (Army Type), Worth treble, 3/- each; Tapping Keys, 5/6 each.
- Dewar Switches. D.P. Change-over, panel type, 2/- each. Small Switch Arms, 6d. each.
- Write for "Complete Supplementary Price List of Exceptional Values," sent Post Free.
- All goods sent CARRIAGE PAID, but with orders under 5/6 add 6d. for postage.
- J. H. Taylor & Co.** Electrical & Radio Engineers. Macaulay St., Huddersfield. Telephone: 341. Telegrams: "Thorough," Huddersfield.



No. 1. The most fascinating hobby explained in simple non-technical style. Price 6d. (7½d. post free).

No. 2. The sequel to "Wireless for All," with full instructional and constructional details. Price 1/- (1/1½ post free).

Recommend these reliable books to your friends just starting wireless.

From all Newsagents or in two days from

Radio Press, Ltd. Devereux Court, Temple, LONDON, W.C.2.

"OOJAH" BASKET INDUCTANCES



We have pleasure in announcing that owing to the reduction in the price of wire and greatly increased output we are able to lower the price of OOJAH BASKET INDUCTANCES to

PER **5/-** SET

Postage 4d.

LIBERAL DISCOUNT TO FACTORS.

All "OOJAH" Inductances are wrapped in a transparent covering and sealed with the Registered Trade Mark "OOJAH."

The Seal is a guarantee of quality. None are genuine without.

"OOJAH" Basket and Slab Inductances are being extensively copied, as most good things are, and purchasers are advised to not only specify "OOJAH" Brand in their order, but to see that the seal is intact.

GREENSLADE & BROWN

LANSDOWNE ROAD, CLAPHAM, S.W.9
Telephone—BRIXTON 639 & 3251.

EDISON BELL MOULDED INSULATORS

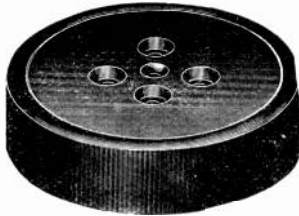

91/92



78

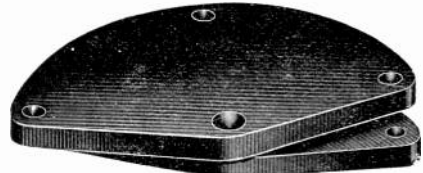

96



74

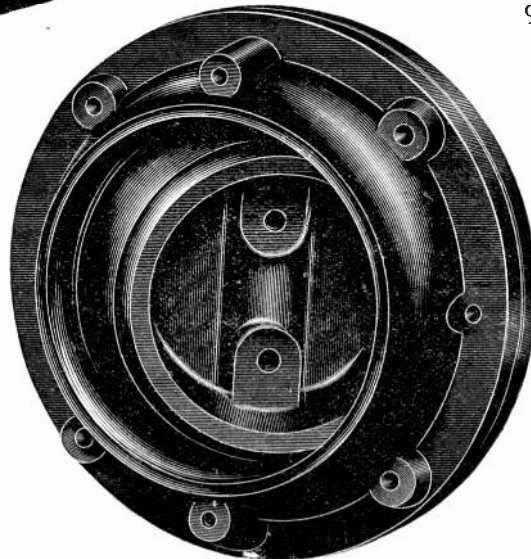

76/101



97

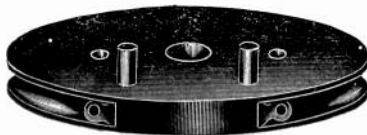

85



70



95

OBTAIN QUOTATIONS DIRECT FROM THE
ACTUAL MANUFACTURERS.
WHOLESALE ONLY

J. E. HOUGH Ltd. 32, Victoria St.
LONDON, S.W.1

Phone—VICTORIA 4115
Telegrams—"OUTNUMBER, VIC."

*You must have
this battery*

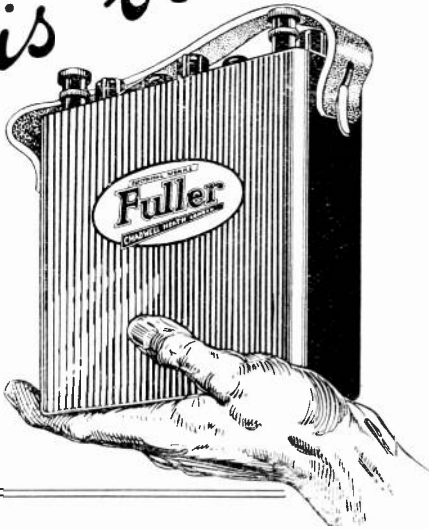

FOR
WIRELESS
WORK
100%
GREATER
OUTPUT



BATTERIES

EXHAUSTIVE tests have proved beyond question the exceptional efficiency and economy of the BLOCK Batteries for all forms of Amateur Wireless Work.

A recent comparative test with Plate Batteries of the same rated capacity when used intermittently with one and two valves for 1, 2 and 3 hours daily shows 100% GREATER OUTPUT due to the wonderful recuperative properties of the Block Batteries.

Made in three types, in ebonite containers with leather handles.

B.W. 6/10	£1	5	0
B.W. 6/20	£2	0	0
B.W. 6/30	£2	12	6

A postcard brings you full particulars of the various types.

There is going to be an enormous demand for these Batteries. Dealers who are not fully stocked should write us at once.

*Sold by Wireless Dealers, Electricians and over 200
Fuller Battery Service Agents throughout the country.*

FULLER'S UNITED ELECTRICAL WORKS, LTD.
WOODLAND WORKS - - - - CHADWELL HEATH

Manufacturers for the Admiralty, Air Ministry and War Office for Wireless Work.

Telegrams: "Fuller, Chadwell Heath."

Telephone: Ilford 1200 (6 lines).



Look for this name

Your guarantee of efficiency.

C.A.Co.

UNPRECEDENTED OFFER OF

Ex-Govt. Wireless Material**AN APOLOGY.**

Owing to the overwhelming number of orders received by us for this Ex-Government apparatus, we have been unable to cope with the tremendous number of enquiries as expeditiously as we would wish.

We respectfully ask the indulgence of readers, and assure them that we will reply to their queries at the earliest possible moment.

In the meantime we are despatching all orders in strict rotation, and guarantee delivery within 48 hours of receipt.

RECEIVERS, C.W. MARK III

This set comprises a complete 2-valve Receiving Set, with a wavelength range of 350-1,800 metres. The addition of High and Low Tension Batteries, valves, and 'phones completes the entire receiving station. For the reception of Broadcast concerts this set is ideal, the strength and clarity of the signals being absolutely wonderful. London readers should take the opportunity of hearing this set working at our Showrooms. **Only 100 left.**

Price £9 9s.

Complete with 4-volt 40-amp. Fuller Block Accumulator, 60-volt H.T. Battery, 2 Mullard "ORA" Valves, and pair of Brown "A" Type Headphones, complete with cords **£15 10s.**

AMPLIFIERS, C. MARK IV

This instrument is a complete 3-valve low frequency amplifier, and can be used in many ways without modification.

The C. Mark IV Amplifier is an improvement on the C. Mark III (the latter being sold by other dealers at £6 5s. each without cases), inasmuch as the C. Mark IV contains terminals and change-over switch, allowing the use of the instrument for either high or low-frequency amplification.

The price at which we are offering these amplifiers is less than the actual value of the transformers contained in the instrument. Limited number only left subject to being unsold.

Complete in Mahogany Case. . . **£4 5s.**

C.W. TRANSMITTERS, MARK III, 30-WATT

For two valves. Complete, with aerial ammeter, platinum-pointed Morse Key, in

Kindly note that the above prices do not include packing and carriage. Please add, therefore, an appropriate amount to cover this. Any surplus will be refunded.

THE CITY ACCUMULATOR CO.

79, MARK LANE, LONDON, E.C.3

Phone—AVENUE 1316.

Wholesale and Retail Distributors for Messrs. BURNEPT, Ltd. Same Trade Discount Allowed as by Manufacturers.

AGENTS—

London: H. V. ALBROW, 56, George Street, Baker Street, W.1.

Glos.: BRISTOL WIRELESS CO., 52, Cotham Hill, Bristol.

Leicester: WALTER ROWE, LTD., 96, Granby Street, Leicester.

S. Wales: SOUTH WALES WIRELESS INSTALLATION CO., LTD., 18, West Bude Street, Cardiff.
N. Wales, Lancs., Ches. & I.O.M.: THE "ALL-BRITISH" WIRELESS MANUFACTURES CO., LTD., 18, Vauxhall Road, Liverpool.

mahogany case. Wavelength range, 300-1,800 metres.

NOTE.—This set can be conveniently converted into a 2-valve **Detector-Amplifying Receiver.**
Price **£3 5s.**

Note.—These Transmitters can be used to transmit music and speech without alteration.

B MARK II RECEIVERS

Vertical pattern. Can be easily converted to any wavelength. **£3 15s.**

Above, fitted with Variable Air Condenser, .0005 mfd., in place of change-over switch. **£4 15s.**

HETERODYNE WAVEMETERS, 500-3,000 METRES

For Receiving, without Galvanometer **£2**

AERIAL MASTS AND EQUIPMENT

15-foot Steel Masts in Sections, each 2 ft. 8½ ins. complete with Halyard, Pulley, and Stays. Can be erected by one man, and are portable. The height can be increased up to 30 feet by the use of extra stays. **Per Set Complete, 15s.**

30-foot DITTO, in SECTIONS, each 4 ft. 3 in. (mast only). **Per Set Complete . . 17s. 6d.**

BROWN HEADPHONES

120 ohms **£2 2s. 6d.**

Complete with new Telephone Transformer (value 25s.) in iron case **£2 15s.**

SULLIVAN HEADPHONES

120 ohms **12s. 6d.**

SULLIVAN HEADPHONES

120 ohms complete with new Telephone Transformer (value 25s.) in iron case **£1 10s.**

Important Notice to all Wireless Manufacturers, Retailers, Experimenters and Amateurs.

EX-GOVERNMENT WIRELESS APPARATUS.

A few weeks ago, we advertised the purchase of a complete Government Wireless Depot and offered the same for re-sale at astonishingly low prices in accordance with our inevitable business rule to

SHARE OUR BARGAINS WITH OUR CUSTOMERS.

The immediate response to our advertisement resulted in our being absolutely "snowed under" with enquiries and orders from all over the country and it was only through despatch staffs working night and day at full pressure that we were able to keep faith with our customers in respect of our promise to execute all orders

WITHIN 48 HOURS OF RECEIPT.

It was impossible to deal with the thousands of enquiries as expeditiously as we should have wished and we again take the opportunity of tendering our apologies to all those who unfortunately were kept waiting.

Moreover we are returning cash to the extent of several hundreds of pounds daily to those who unfortunately were too late to avail themselves of the wonderful bargains we offered, for when once the stock of any particular line is disposed of

IT IS IMPOSSIBLE TO REPEAT AT ANY PRICE.

As an example, the Hand Generators and Galvanometers were all sold by *Telegraphic Money Order* within a few hours of our advertisement appearing. The public are aware that it is possible to deal in this way with a firm of repute making the unconditional offer, as we do, to forward

EVERY ARTICLE ON APPROVAL FOR 7 DAYS.

We hope in the near future to be able to repeat our bargain offers from time to time and we invite the Wireless public to assist us so that we can more expeditiously deal with the demand as it arises.

By filling in the Form at the foot of this page

YOU WILL BE PLACED ON OUR MAILING LIST.

Immediately this Form is received, an envelope will be addressed in readiness and the moment we have a bargain to offer everyone on our mailing list will be informed simultaneously.

FILL UP THIS FORM NOW

and post to us immediately. ½d. stamp only required.

Messrs. THE CITY ACCUMULATOR CO.

MAIL ORDER DEPT.,

79, MARK LANE, LONDON, E.C.

Please include my name on your Mailing List. I am particularly interested in

.....
.....

(Signed)

Full Postal Address

.....

WIRELESS WORLD.

Date 19

EXPERIENCE

A Great British Triumph

On a modest three-valve set (D. and 2 L.F.), built up from components with many of the connections temporarily made for the purpose of the test, Mr. R. E. Williams, of Holyhead, North Wales, has eight times listened in for telephony from America and has every time been remarkably successful. He is now convinced that he can get the American Telephony whenever he likes to stay up for the purpose.

Well over a dozen different American Stations have been picked up and logs have been kept of broadcast programmes received from W.J.Z., Newark, U.S.A., extending over two hours. Reception is sometimes so strong that the signals can be heard with the 'phones resting on the table.

The receiving aerial is only 52' long and of the twin inverted "I." type with an average height of 30', while a good deal of local screening and interference exists.

Immediately before achieving these extraordinary successes Mr. Williams fitted two of our standard R.I. Intervalve Transformers in place of the ones used previously. Other R.I. components are used in the set. These R.I. Transformers are the finest in the World, and it is gratifying to know that they are produced solely by British brains and British labour.

This transformer is used by more manufacturers of wireless sets than any other make of transformer, for the following reasons:—

BECAUSE it is wound with heavy gauge wire, thus avoiding the unreliability of the ordinary transformer, which being wound with fine wire carries only a small factor of safety.

BECAUSE whatever may be used on Wireless Instruments, it pays only to use the best possible transformer.

BECAUSE although of excellent design and sound construction it is sold at a very low price.

BECAUSE its exceptional absence of noise and vibration allows a larger range of amplification to be employed.

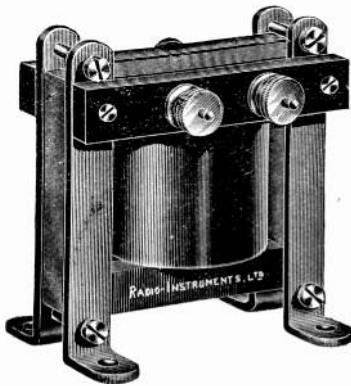

PRICE

Intervalve Transformer	- -	25/-
Telephone	- - - - -	20/-

Order at once to secure Immediate Delivery.

Many testimonials received from satisfied customers (originals of which can be seen at our works) prove this transformer to be considerably in advance of anything previously designed for audio frequency amplification. It is the ideal transformer for amplification with a crystal set.

Members of our research staff were the originators of the first H.F. intervalve coupling to be placed upon the British market and were also responsible for the design of the H.F. Reactances with which the first American Broadcasting Concerts were received.

RADIO INSTRUMENTS LIMITED

Managing Director: J. Joseph, M.I.E.E., late Manager to Mr. H. W. Sullivan.
 Chief Designer: W. A. Appleton, M.B.E., M.I.R.E., late Admiralty Technical Research Officer.

ONLY ADDRESS: Works, Offices and Showrooms:

12, Hyde Street, NEW OXFORD STREET, W.C.1

Telephone: Regent 1908.

Telegrams: Instradio, London.

EFFICIENCY INDUCTANCES

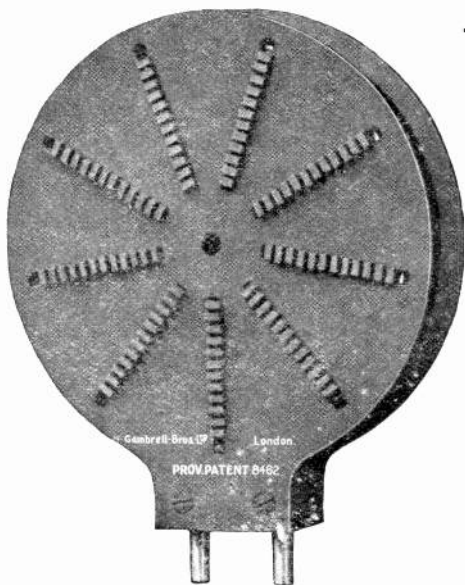

DO THE INDUCTANCES YOU ARE USING POSSESS THE FOLLOWING GOOD QUALITIES ?

Very low effective resistance.

Negligible self-capacity.

Large range of wavelengths on given condenser.

Great mechanical strength.

All inductances of uniform size.

OURS DO !!

On 100' P.M.G.* Aerial with .00065 Microfarad Maximum Condenser				Secondary Circuit with .00024 M.F.D. Max. Condenser		Self Capacity of Coil Microfarads	Price	
	Series		Parallel					
A	175	260	325	510	110	275	.000004	5/9
B	275	415	495	825	175	430	.000005	6/-
C	380	530	690	1150	255	610	.000006	6/9
D	530	750	975	1625	365	875	.000006	8/-
E	880	1200	1600	2700	600	1400	.000008	9/6
F			2550	4200	950	2275	.000009	10/3
G			3650	6200	1400	3250	.000011	12/-
H			5800	10000	2350	5300	.000014	14/-

It will be seen from the above table that the self-capacities are extremely low and that the secondary circuit ranges of wavelengths are obtained with only a .00024 M.F.D. variable condenser. Double plug or plug and socket can be supplied.

These inductances and apparatus incorporating them can be seen and demonstrated at our works or at the showrooms of **T. ALLISON, 127, FULHAM ROAD, SOUTH KENSINGTON.**

GAMBRELL BROS., LIMITED,
MERTON RD., SOUTHFIELDS, LONDON, S.W.18

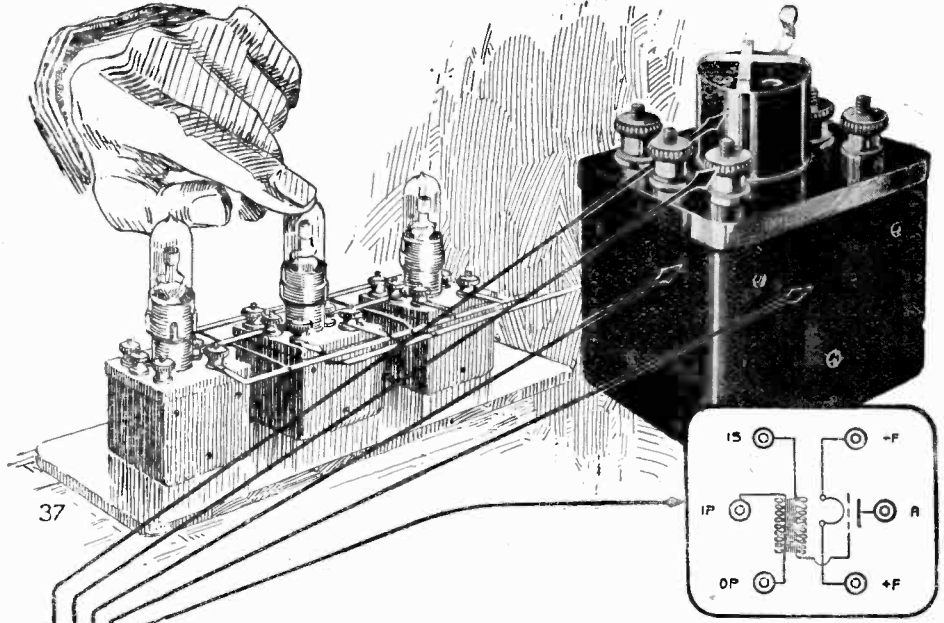
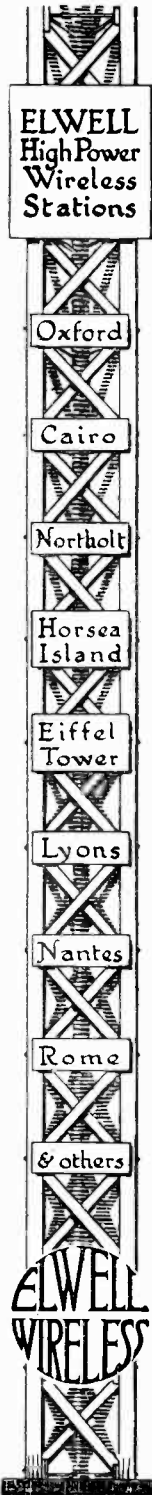

No need to spend time making these connections. The Elwell note magnifier contains them ready made.

The interval transformer is contained in an iron case, allowing units to be placed close together without howling.

Tapped holes in two sides and base make fixing easy. The unit will also stand alone.

All connections are embedded in compound and brought out to terminals. No soldering necessary. The perfect insulation of the grid connection ensures silent operation.

The valve holder has specially long leakage paths and an earth clip.

Overall Dimensions:—3 3/4" x 2 5/16" x 2".

This patented amplifying unit, when provided with a valve and connected as marked on the terminals, is all that is necessary to give one stage of note magnification to your existing set.

Two, three or more units may be coupled as shown, to give as many stages of note magnification as required.

PRICE 39/6 each.

AMPLIFYING MADE EASY.

When building a valve set, do not buy interval transformers. Use Elwell Amplifying Units. They save time, money and trouble.

When buying a valve set, select one using these units. They enable the manufacturer to give you a better job at a lower cost.

The unit featured is a note magnifier.

A similar design of unit is available as an oscillation amplifier and a third design as a rectifying unit.

Elwell Amplifying Units are entirely British made.

WRITE US OR CALL.

C. F. ELWELL, LTD., Radio Engineers,
CRAVEN HOUSE, KINGSWAY, LONDON, W.C.2
 Telephone: REGENT 421.

HOGARTH ENGINEERING CO.

Wireless Showrooms
have been opened at
**72 REGENT ST.
PICCADILLY.**

Demonstrations
given daily of Broad-
cast and experimental
Wireless Receiving
Apparatus of all lead-
ing manufacturers.

Experimental Apparatus made to order.

WORKS - - - CHISWICK.

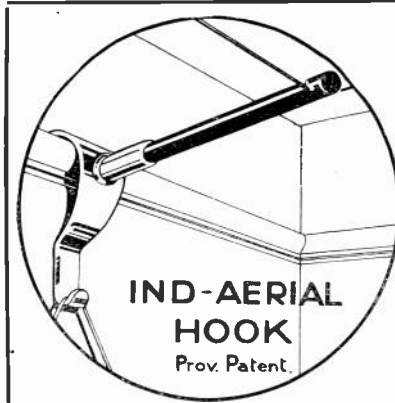

**Why hide
Yourself
in
the Attic
with your
Set?**

Why not
sling up an
aerial in the
drawing-
room with a
few IND-
AERIAL
HOOKS and
let the family
listen-in?

*IND-AERIAL HOOKS are attached and detached in a moment. They support the aerial ONE FOOT FROM THE WALL.

A 12'x12' room gives a total length of 40 to 50' of aerial by just following round the walls, but much longer lengths may be obtained by leading the wire from hook to hook across the room.

*P.O. for 10/6 brings four post free.

TO THE MANUFACTURER AND DEALER.

How many prospective radio users are unable to have an outside aerial? How many landlords object?

We suggest it will pay you to stock IND-AERIAL HOOKS for they not only sell themselves but they sell your radio sets as well. Write for trade terms to

IND-AERIAL CO., 47 Victoria Street, S.W.1.

Agents Wanted in all Broadcasting Towns.



Telephone :
GERRARD 6785.

Telegrams:
WIRECLIP, WESTCENT.
LONDON.

RADIO ENGINEERS & MANUFACTURERS.

3 Valve, Type M.2
RECTIFIER
2 Note
AMPLIFIER

PRICE

£18 : 18 : 0

REG. G.P.O. 0179.

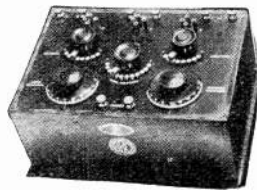

Complete range of sets
passed by the P.M.G.
for Broadcasting re-
ception. Transmitting
and Receiving Sets
and full range of com-
ponents for Amateur
Experimenting in stock.

*Call and inspect them or
write for illustrated List
"G"*

AGENTS REQUIRED.

WIRELESS EQUIPMENT LTD.
90 CHARING CROSS ROAD : : W.C.2



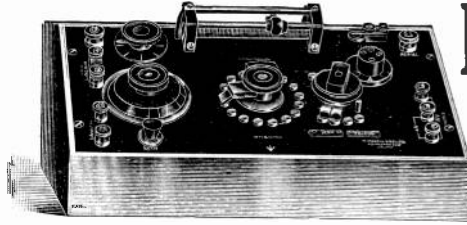

Electradix Radios

£40 FOR A FIVER! Marconi's finest work, polished mahogany cabinet, sloping front. Ideal experimental panel. For crystal, 1, 2, 3, or 4 valves. Only set with calibrated waves on cond. dial, 300/600. Plug-in for any wavelength over. Price as shown with 2 valve holders fitted, **£6 10s.**; 3 ditto, **£6 15s.** 4 ditto, **£7.** In box form with lid and transmitting gear, new and costing **£40,** for **£5** only. 'Phones and Aerial equipment, **28/-** extra.

H.T. BATTERY BOXES. Mahogany with ebonite-insulated plug-sockets and 2 plugs, 60-volt size, 4/-, to 100 volt size, 7s.; 200 volt size, 7/6. Extra sockets, 6d. Plug, cord and lug, 9d.
BATTERIES. P. & R., 6-volt Bullpup, 30 amp., 42/-. Willard, 6/8 volt S.H. 20 amp., 15/-. Fuller block, 2 volt 100 amp., 21/-. Boxes with strap and lid, 2/6. Dry cells all sizes.
AERIAL OUTFITS. 100' 7/22 Enamelled stranded copper, 4/6. 6 R.A.F. small insulators, 3d. each. Two Navy bronze wheel pulleys, 1/6 each. Lightning arrester and 4 terminals, 2/6. Earth clip, 6d. Porcelain leading in tube, 2/-. 12 yards rubber down lead, 1/-. The 15/- set for 10/6 post free.
VAR. CONDENSERS. All sizes. Table moulded ebonite case, very fine .002 m.f., 35/-. Murdocks, from .001, 25/-, to .0005 at 21/-. Marconi, .01, 25/-. Fixed for H.T. batt., stops noises, 2 m.f., 1/6. Dubilier, 2/6.
TRANSMITTERS. 1 Valve C.W. Mk. III, £3 10s. 1" Spark Sets, new, key, etc., 15/- Water-tight Morse keys, 2/6. 3-Valve Amplifiers, £4 15s. Wavemeters, £3. Micros, 1/- to 15/-.

TELEPHONES. 2,000 in stock. New Government Single, 3/6. Pair headbands and cords, 7/6. Sullivan, 12/6. Sterling, 45/-. 2,000 and 4,000 Tel. Complete exchanges, **£2 10s.** Field cable, 4/- 100 yards.
DYNAMOS. Charging 6/8 volts, 70/-. 12 Volt, £4. 20 Volt, £8. 500 Volts, £16. 3 1/2 K.W. Set, £80. Motors, D.C. and A.C. Regulators, 20/-.
SUNDRIES. New, panel jacks and plugs, 1/6 pair. New 3-way Dewars, 4/6. Aerial Switch, 2/8. Ivorine labels, 6" x 1 1/2", 6d. Insul. compound, 1/- stick. Rubber, 23/40's flex., 1d. yard. Buffer Res. Units, prevent fil. burnouts, 1/-. 4" H.T. voltmeters to 80 volts, 25/-. to 120 volts, 30/- 2 1/2" to 15 volt or 30 volt, 10/-. Fil. ammeters, 0-3, 10/-. 4" Milliammeters, 0-6, 30/-. 6" 0-120 m.a., 32/-. Taylor Hobson Angle-Plotters, in leather case, 8/-. Teak cabinets, ebonite panel, 13 x 11 x 5, 8/6. Valve legs and nut, 1/- doz. Buzzers, 2/-. Bells, 4" gong, 2/-.



THE HANDIEST DEPOT FOR CITY BUYERS
 Near Aldgate Station, Met. Railway.

LESLIE DIXON & CO., 9, Colonial Avenue, Minories

Proclamation

This is to announce that on

JAN. 15th

Radio Press Ltd., the well-known publishers of authoritative wireless books, will publish a new monthly wireless Magazine, entitled—

"MODERN WIRELESS"

112 Pages 1/- Nett 20,000 copies already ordered

Make sure of YOUR copy by ordering at once.

Every reader of the "WIRELESS WORLD" should obtain the first brilliant number. The Magazine is edited by John Scott-Taggart, F.Inst.P., assisted by E. Redpath, Author of Cassell's Work Handbook, "Wireless Telegraphy and Telephony," and by Paul D. Tvers, Author of "Construction of Wireless Receiving Apparatus," well known wireless writers. Order your copy from your newsagent bookseller, from a railway bookstall, or direct (1/3 post free) from—

Radio Press Ltd., DEVEREUX COURT, TEMPLE, LONDON, W.C.2

EFFICIENCY



Standard plug type
Honeycomb Coil.

Maximum Efficiency
is obtained for any given
range of wavelengths in
either single circuit or
coupled circuit receivers by
using

HONEYCOMB Inductance Coils

(De Forest Patent)

Any desired range of wave-
lengths can be covered by
merely changing the size of coils.

Made in two types of mounting :

PLUG TYPE and
GIMBAL TYPE

We also manufacture

COIL HOLDERS
INTERVALVE
TRANSFORMERS
FILAMENT
RHEOSTATS



Gimbal type Honeycomb coil.

Write for Pamphlets U2.

Manchester—30, Cross Street
Birmingham—73 74, Exchange
Buildings
Glasgow—50, Wellington Street

**149, Queen Victoria St.,
LONDON.**



Cardiff—Western Mail Chambers
Bradford—18, Woodview Terrace,
Manningham
Newcastle—90, Pilgrim Street

Works :
Elstow Road, BEDFORD

THE WIRELESS WORLD EXCHANGE AND MART

TARIFF. Advertisements are accepted for this Section at the rate of twopence per word, with a minimum charge of two shillings. The advertiser's name and address will be charged for, and single letters and single figures will be counted as words. Compound words will be counted as two words.

DEPOSITS. All advertisements must be prepaid in the form of Postal Orders, the remittance being forwarded to Messrs. Bertram Day & Co., Ltd., 9 & 10 Charing Cross, S.W.1.

Intending purchasers may deposit the purchase money of any article advertised or sold by advertisers with Messrs. Bertram Day & Co., Ltd., who will acknowledge its receipt to the vendor and the depositor, the full addresses of whom should be given. Subject to special agreement between the parties, it is understood that all goods are sent on approval, each party paying carriage one way in the event of the goods being returned. The deposit will be retained until due advice of the completion of the purchase has been given or until the articles have been retained and accepted. In order to cover postage, etc., a fee of 6d. in respect of sums of £1 and under and 1s. for sums in excess of £1, must be paid at the same time as the deposit. For persons not resident in the United Kingdom these fees are doubled. We cannot undertake to receive any deposit less than 2s. 6d.

FOR SALE.

Make your own High Tension with a Rowcell Cabinet, no screwing or soldering required.—28, Rendezvous Street, Folkestone.

B. Mk. 1st 2-Valve Receiver, new condition, polished mahogany case, £4 10s.—W. SEED, Crigglestone, Wakefield.

Wireless Amateur has for disposal Tingey 3-valve receiving set ready to receive signals and broadcasting. In perfect condition.—MILLER, 13, Henrietta Street, Bath.

Phones, 4,000 ohms, new, 18s. per pair. Postage extra. Two new Inter-Valve Transformers, 15s. each.—M. L. 146, Bridge Street, Mile End, E.3.

Single Valve Set, complete, valve panel, slide tuner, variable condenser, Mullard Valve, and headphone As new, only £3 19s. 6d. Carriage paid.—"ABRO" MOTOR Co., 184, London Road, Manchester.

Basket Coils, Set Seven, 150 to 5,000 metres, 4s., postage paid. Formers, 9d. each.—ALPHA Co., 42, Marion Road, Hilsbro, Sheffield.

Sullivan Double Reactance Panel, all waves, cost 68s., for 40s. Sullivan wet anode battery, 50s. for 15s. "Ducon", 6s. 6d., well made, experimental frame, wound exactly right for broadcasting, 16s. 6d. Electric motor horn, 22s., for 9s. 6d.—H., 44, Carew Road, Eastbourne.

Townshend's Wavemeters, 50s. Complete except calibrated dials, P.O. Relays, 25s.; Western relays, 25s.; Lucas signalling sets, 15s.; C. Mark III Amplifiers, £6 10s. (perfect); Morse inker (as new), £10. Three days approval against cash, cash with order.—RIDGEWAY, Radio, Wimbledon.

Burndepi Mark VI 3 Coils Tuner, with set of 7 coils, 3 valves, receiver unit system, Peto Scott with tuner, batteries, condensers, etc., etc., £17 the lot (worth £30). Splendid bargain as the lot is brand new. Call please to inspect. W. H. GARDAM, 7, Poultry, London, E.C.2 (5th floor). Also 1 brand new Armstrong Super Regenerative Receiver, complete with 3 P.A. valves, batteries, frame aerial, telephones, etc., etc., giving splendid results, £40 the lot, or near offer.

Sullivan Three-Valve Note Magnifier Panel with rectifying switch. Perfect, ideal for experimental work, £5 10s. Two tapped anode reactances on panel with switch, 150-4,000 metres, Sullivan make, £1 5s. Navy buzzer wavemeter in teak case, with charts, 100-8,000 metres, £5. Sullivan inductance, in case, ebonite top and selector switch, reaction coil, litz wire, 200-3,000 metres, efficient, £3.—LAVIN, Old House, Sonning, Berks.

Ex-Government, Brown's H.R., 21s., L.R. 18s. 6d. Sullivan's H.R. 7s. 6d., L.R. 5s. 6d. All with Brown's headbands and cords. Two-valve L.F. trench sets, £2 15s., with variable condenser £3. 20-Watt transmitters, 16s., with frame aerial 17s. 6d. Sundries of many sorts, send wants, postage extra, please.—STOCKDALE, Sawmills, Eastleigh.

Crystal Set, gets Paris, broadcasting (40 miles), in polished mahogany 28s., with Federal 'phones, 20" mast, aerial complete, 75s. or nearest.—JOSCELYNE, Rushmere, Braintree.

Marconi Units, Condenser, tuner (300-20,000), 1 H.F. amplifier, 1 detector unit, also coils A1, A.B.C.D. Condition perfect, cost £24 last September, take £15 or nearest offer.—SWALLOW, Apseheath, Sandown, I.W.

Microscope by Beck, very powerful, 1" and 1" objectives. Exchange for good L.F. amplifier, or sell £3 5s.—ARNOLD, 4, Steele Road, E.15.

One Gross of Crystal Receiving Sets, high quality, British made, registered, approved P.M.G., etc., for quick sale, with all manufacturing rights.—Apply A. KAMINSKY, 18, Featherstone Buildings, London, W.C.1. Phone, Holborn 1056.

All Wireless and Electrical Goods stocked at 9, Colonial Avenue, Minorities, near Aldgate Station. Handiest place for City buyers.—LESLIE DIXON & Co., Telephone No. Avenue 4166.

Agate Cylinders, etc., for loud speaking apparatus from JAMES R. GREGORY & Co., Mineralogists, 139, Fulham Road, S.W.

BACON AND COATES, Radio Supplies Depot, Royal Arcade, Keighley.

SPECIAL THIS WEEK.

Flash Lamp Batteries for H.T., new, doz.	5/6
Flash Lamp Batteries for H.T., soldered	6/6
100' 7/22 Copper enamelled wire	5/-
Aerial Insulators, non-hygroscopic, each	4d.
Filament Rheostats, extra smooth, each	4/6
H.F. Transformers, 300, 400 and 600 metres	3/9
H.F. Transformers, formers only, each	2/3
L.F. Transformers, tested 1,000 volts.	22/6
Switch Arms, 4-ply copper	2/6
Ebonite (guaranteed)	1b. 4/6
Contact Studs with nuts	doz. 1/6
Condenser Vanes, polished	pair 1 1/2d.
Condenser Washers, fixed vanes	doz. 3 1/2d.
Condenser Washers, moving vanes	doz. 6d.
Condenser Spindles, according to length.	
Condenser Screwed Rod	ft. 6d.
Condenser Scales, engraved ebonite, each	3/6
Condenser, complete, .0005	each 13/6
Condenser, set of parts	per set 11/6
Sistoflex, strong	yard 6d.
Terminals	doz. 2/6
Dubilier Condensers	each 2/6 and 3/-
Do. Grid Leaks, 2 megohm, each	2/6
Brown 'phones, new, 4,000 ohm, pair	30/-
Stop Pins	doz. 4d.
Split Pins	doz. 1/6
Mullard ORA Valves, tested	each 15/-
B.T.H. Valves, tested	each 15/-
Polished ebonite knobs	each 6d.
Ebonite Valve Sockets, polished, screwed legs	each 1/4
Ebonite Valve Sockets, polished, with flange	each 1/10

Orders over £2 carriage paid.



WESTON MOVING COIL RELAYS,

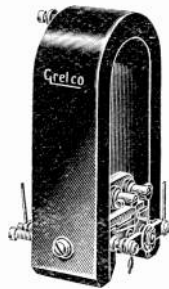

Undoubtedly the most Sensitive Relay made. Platinum Contacts, eminently suitable for wireless recording or Experimental work. Perfectly new as received from makers.

Price, 20/- each. Packing work, and post, 1/6. Note: These originally cost the trade £8 to £10 each.

Basket Coils (150 to 4,500 metres), excellent for telephony. Per Set 5/-

- Grid Leaks (enclosed), 2 meg. 1/-
- Aerial Wire, stranded, 7/25, 100' 3/-
- Filament Resistances 3/6
- Perikon Detectors on ebonite, complete with crystals 4/-
- Valve Holders, screwed legs 9d.
- Highly Glazed Green Egg Insulators. Best for aerials. 4d.
- Knobs, best quality, with 2 B.A. brass inset 4d.
- Siemens Halske Valves, excellent for amplifying and rectifying 7/6

All Goods dispatched the same day as order received.

Catalogue in preparation. Postage extra.

Grafton Electric Company
Showrooms—54, GRAFTON STREET, TOTTENHAM COURT ROAD, LONDON, W.1. Telephone—Museum 241. Works—Slough.

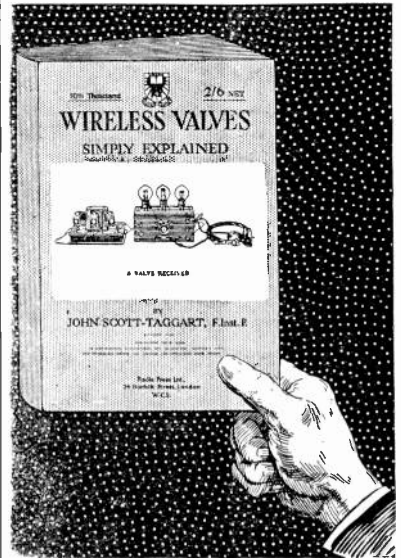

Whether you buy a complete receiving set or design it yourself, this book at 2/6 will save you time, trouble and money.

GET IT TO-NIGHT AS YOU GO HOME

Obtainable from all newsagents and bookstalls, or send us P.O. for 2/6 and your copy will reach you in two days.

Radio Press Ltd.

Devereux Court Temple, London, W.C.2

THE WIRELESS WORLD EXCHANGE AND MART

Portland's Parts by Post. "EBONITE"

	s. d.		s. d.
8x1	0 7	12x10	7 6
4x4	1 3	17½x 8½	9 6
7x5½	2 8	18x18	12 10
10x6	3 9	36x18	£1 3 0
17x5	5 3	7lbs.	£1 3 0

Quarter, Mat, British. Postage free.
Any size cut.

JAMES PORTLAND

39, Sinclair Road, Olympia, W.14
Mr. Portland stocks 200 Wireless Parts

RADIO PRESS



WIRELESS DIRECTORY

PRICE 2/6 NET

An absolutely up-to-date and complete list of all land, ship and amateur call signs. 12,000 call signs. It is as much a necessity to the real experimenter as a telephone directory is to a telephone subscriber.

PRICE 2/6 NET.
Post free 2/8

Order your copy at once through the trade or direct from

Radio Press Ltd.
Devereux Court, Temple, London, W.C.2.
(Opposite the Law Courts).

FOR SALE—continued.

Huge Purchase of Ex-Government Wireless Stock.—Write for list giving full details. 150-watt dynamos, £1; loud speakers, 200 ohms, 7s. 6d.; 1" spark coils, 10s.; 1½" spark coils, 12s. 6d.; Morse tapping keys, 3s., etc., etc., etc. Three days' approval against cash, or please call. Write for detailed price list of all goods.—E. J. GALPIN, 16, Loampit Hill, Lewisham, S.E.13, London.

B.A. Screws, Nuts and Washers, assorted gross 2s., lists 2d.—J. H. BENNETT, Station Road, Willesden Junction.

Loud Speaker Horns, guaranteed perfect acoustics. Enamelled black matt, complete with polished aluminium base for receiver, 4s. 6d. Post, etc., is.—MIDLAND RADIOPHONE Co., Hearsall Works, Coventry.

R. Valves Moorhead, 10s. each. Osram, 14s. B. Valves Moorhead, 12s. each. B.T.H., 17s. 6d. each. All new and tested. Post free. Ebonite variometer rotor, 5s. each.—B. CALVER, 52, Liner Road, London, S.W.6.

Loud Speaker, mounted on polished mahogany base, 16" horn, with 4,000 ohm receiver. A bargain, 25s. Packing, etc., is. 6d.—WILLIAMS, 1, Allesley Old Road, Coventry.

A Few High-grade Potentiometers in teak box, with change-over switch. Only 8s. 6d. Order yours NOW. Box F. 8. BERTRAM DAY'S ADVERTISING OFFICES, 9 and 10, Charing Cross, S.W.1.

Brown Loud Speaker (Small).—High resistance curved horn, as new. Owner purchased larger. £2 2s. 6d. EDWARDS, 22, Benheim Road, Caversham, Reading.

SITUATIONS WANTED.

Gentleman with Wireless Experience as Manager, seeks post, large or small works, keen organiser, used to production in all its branches. Commercial, and purchasing experience also.—Address, "WIRELESS," 3, Beaufort Gardens, Lewisham, S.E.13.

MISCELLANEOUS.

Telephone Receivers Rewound up to 1,000 ohms, 5s.; 2,000, 7s. 6d. Cash with order.—M. E. HAMPSHIRE, 139, Sydenham Road, S.E.26.

East Ham, Wanstead, Ilford, Manor Park and Forest Gate. Amateurs should not fail to come to the **RADIORENDEZVOUS**, 709, Manor Park Broadway (over Liptons). Club open till to p.m. nightly.

WANTED.

"Polar" Receiving Set, good, cheap.—Box P. 8, BERTRAM DAY'S ADVERTISING OFFICES, 9 and 10, Charing Cross, S.W.1.

BOOKS.

Technical Books.—Second-hand and New books on every conceivable subject. Catalogue free. State wants. Books sent on approval Books bought.—FOYLE, 121, 125, Charing Cross Road, London.

AGENCY WANTED.

Birmingham Firm, with extensive connection, offices, showrooms and shop, is open to accept Agency for known and reliable Radio Sets.

Apply: Box C.7, **TOON & HEATH, LTD.** Advertising Contractors, **HOLBORN CHAMBERS, BROAD STREET CORNER, BIRMINGHAM.**

ALL BRITISH PHONES

21s. per pair. Post Free. (4,000 ohms)

Illustrated Catalogue including List of Stations, 6d. Post Free.

EONS WIRELESS SUPPLY Co.,
:: :: 115, Fleet Street, E.C.4. :: ::

ELECTRADIX WIRES

Highest Gauge.	Conductivity D.C.C.	at Lowest S.S.C.	Prices. D.S.C.
16	1 7	—	3 6
18	1 9½	—	3 9
20	1 11	4 0	4 9
22	2 5	4 6	5 0
24	3 0	5 0	5 9
26	3 6	5 6	6 6
28	4 2	5 9	6 10
30	5 2	6 6	8 1½
32	6 6½	8 2	9 0
34	7 9	9 6	10 7
36	9 2	11 3	12 3½
38	11 10	13 6	17 3
40	16 2½	17 0	23 5

Other sizes in stock. Prices at per lb. 3d. extra for reeling off in small quantities and spool. Postage extra. 7/22 Hard Drawn Copper Aerial Wire, 4/6. Enamelled Copper 5/6 per 100 ft. **EVERYTHING FOR WIRELESS IN STOCK.**

LESLIE DIXON & CO.,
9, Colonial Avenue, Minories, E.1
(near Aldgate Station) Telephone: Avenue 4166.

'PHONES CHEAP

New Army for Crystal or Valve .. 10/- pair
8000 ohm French, with cords .. 22/6
Brown's 8000 A Type .. 42/-

Postage on each pair 9d.

Send for our List.

95, 97, 99, 101, HOLLOWAY ROAD,
LONDON, N.7.



LIVERPOOL MARINE AND GENERAL INSURANCE CO., LTD.

London Office: 7, Angel Court, Throgmorton St., E.C.2.

FIRE. ACCIDENT. MARINE.

Write for particulars of our **SPECIAL WIRELESS POLICY** (Annual Premium 7/6) which covers fire and other damage to the complete Wireless Set and also indemnifies the Owner against claims arising from damage to property or persons through the breakdown of outside aerial and its supports.

BARGAIN CORNER

FILAMENT RESISTANCES 2/9
Note Magnifier Units .. 42/6
Switch Arms 2/-

The Suffolk Wireless Supply,
FELIXSTOWE, Suffolk.

HEATH & Co., Ltd.

Instrument Works, New Eltham, S.E.9 are prepared to undertake in their fully equipped works—**Wireless Apparatus and Parts for the trade.** Quotations given to Blue Prints. **Immediate attention.**
Phone—Lee Green 301. Wire—Polaris, London.

THE WIRELESS WORLD EXCHANGE AND MART

Your Case Work

Let us quote you for your wireless casework. We are specialists in this class of work and feel sure our workmanship and prices will interest you.

Phone—L.W. 2720.

CARRINGTON & NEWBERY LTD.,
18/20, Normans Buildings, Old Street, E.C.

BOOKS—continued

Old-established London Firm, making one to five-valve broadcast receivers, desires provincial agents. Every assistance and good terms offered.—Box 76, c/o F. ALDRIDGE, 26, Paternoster Row, E.C.4.

TRADE ENQUIRIES.

Advertiser shortly opening showrooms and offices in important West of England Town for the sale and actual demonstration of Wireless Broadcasting Sets and parts, desires trade quotations and catalogues from manufacturing firms. Agencies, on agent or factor basis solicited.—Box 0.4, BERTRAM DAY'S ADVERTISING OFFICES, 9 and 10, Charing Cross, S.W.1.

Will Manufacturers of Radio Sets and Components kindly forward trade lists and agency terms to A. C. DIXON, Wireless Engineer, 3, East Parade, Leeds.

Wireless Inventors.—Patents and Trade Marks Advice. Handbook and Consultations free.—KING, Regd. Patent Agent, 146A, Queen Victoria Street, London. Phone, 682 Central.

Scientific Instrument Maker, manufacturing "Wireless" parts, cabinets, etc. Let me quote you for parts or complete sets, quotations from samples or blue prints.—MAIN, Scientific Instrument Maker, 50, Oakley Road, South Norwood, S.E.25.

ESTABLISHED TWENTY-FIVE YEARS.

J.W.B.

ACCUMULATORS

RESULT OF OVER 40 YEARS' EXPERIENCE.

4v. 40a.	.. 18/-	6v. 40a.	.. 28/-
4v. 60a.	.. 21/-	6v. 60a.	.. 31/-

PLATES, SETS, BOXES, SEPARATORS, REPLACEMENTS, EXPERT REPAIRS.

J. W. BARNARD

WORKS: 45, GT. ORMOND STREET, LONDON, W.C.1, and 4, GT. WINCHESTER STREET, LONDON, E.C.2

BOOKS—continued.

Radio Magazines, all the latest, "Radio World," 10d.; "Popular Radio," 10d.; "Radio Broadcast," 1s. 6d.; "Radio News," 1s. 6d.; "Science and Invention," 1s. 9d.; "Scientific American," 2s. 6d. Post free.—INTERNATIONAL NEWS COMPANY, LTD., 15, Bream's Buildings, London, E.C.4.

Wireless Dealers throughout Great Britain are strongly advised to stock parts for making up wireless sets. Buy your parts direct from the factory at wholesale prices.—NEWTONIA WIRELESS FACTORY, 13 and 15, Whitcomb Street, W.C.2.

TRADE ENQUIRIES—continued

Cheap Trade Prices in Terminals, Studs, Legs, crystal cups, etc.—MACRADIO WIRELESS SUPPLIES, 30, Queen's Crescent, London, N.W.5.

EBONITE SHEET.

LOW PRICES. HIGH GRADE MATERIAL.

USUAL SUBSTANCES IN STOCK.

FULL SIZE SHEETS OR CUT TO SIZE.

Quotations on receipt of particulars.

R. C. HILLS, 48, FENCHURCH STREET, LONDON, E.C.3

The YEAR BOOK of WIRELESS Telegraphy and Telephony 1922

1476 Pages.

Price 15/- Nett.

Demy 8vo.

Postage Inland 1/.

Abroad 1/4.

CONTENTS :-

Record of the Development of Wireless Telegraphy—National and International Wireless Laws and Regulations—Directory of the World's Land and Ship Wireless Stations—International Allocation of Call Letters—Alphabetical List of Call Letters—Meteorological Section—International Time and Weather Signals—National Resumes of Progress in Wireless Telegraphy—Particulars of Wireless Telegraph Patents, 1921—Aviation Section—Tabular List of Aviation Stations—Useful Data Section—Wireless Terminology—Conventional Signs used in Wireless Diagrams—Companies Engaged in the Commercial Development of Wireless Telegraphy—Biographical Section—Literature on Wireless Telegraphy and Telephony—Directory of the World's Wireless Societies—Directory of Wireless Colleges and Schools—List of Licensed Amateur Transmitting Stations—Code Section—Special Articles on "The Earthing Resistance of Antennae," by Dr. Miessner—"The Recording of Wireless Signals," by Dr. Abraham—"The Birth and History of Long Distance Wireless Telegraphy"—"The Rectification Effect in its Reaction to the Composition and Structure of Crystals."

A valuable feature of the present issue is the specially drawn map, which gives, for the first time, a simple means of finding the distance and true direction of Wireless Stations in all parts of the World, from London as the centre.

THE WIRELESS PRESS. LIMITED,

DEPT. W.W., 12-13 HENRIETTA ST., STRAND, LONDON, W.C.2

"BUTTLO" BROADCAST RECEIVERS

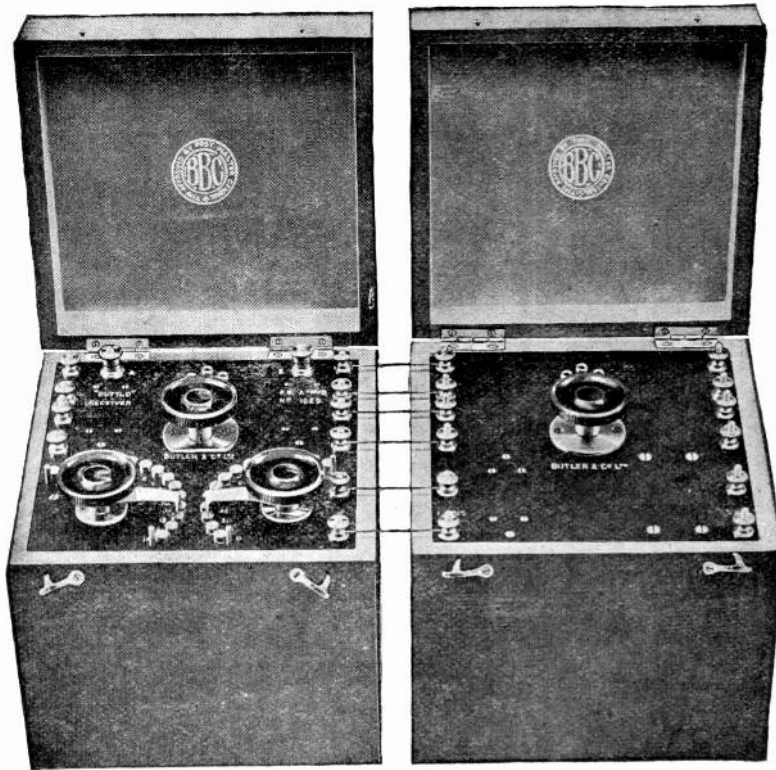

Approved by H.M. Postmaster-General.

Manufactured under Marconi Licence.

Fig. B.B.C. 1.

Fig. B.B.C. 2

Prices include Marconi Royalty and B.B.C. Commission.

1 VALVE RECEIVER
as illustration ... £5 10 0

Complete with 4 volt 40 A. H. Accumulator, 60 volt H.T. Battery, One pair super-sensitive double ear-piece Phones, 100 ft. copper stranded Aerial Wire, 2 porcelain Insulators, Marconi Osram R Valve

£10 : 18 : 9

AMPLIFIER UNIT
as illustration ... £4 5 0

Complete with Marconi Osram R Valve

£6 : 2 : 6

H. D. BUTLER & CO., LTD.

Telephone Numbers—
Showroom : Hop 3029
Office and Works :
North 1838 Extension

Showrooms : BARCLAYS BANK BUILDINGS,
222, GREAT DOVER ST., BOROUGH, S.E.1
Offices & Works : 29, HALTON RD., CANONBURY, N.1

The IONOPHONE VARIOMETER TUNED BROADCASTING SETS

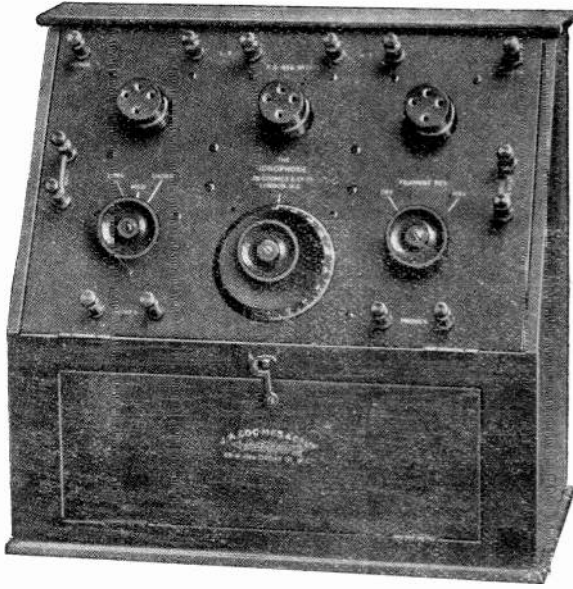

Three Valve Set

This is the cheapest and best three valve Set on the market. Owing to the restrictions of the P.M.G., Broadcasting reception has been made very inefficient for the public. This Set has been specially designed to give practically as good results as Sets having variable retroaction which are only available to those who can obtain experimental licences.

Range 300-3,000 metres. Receives all Broadcasting, including the Hague and Paris Concerts.

PRICE (including phones and H.T. battery) £14

Plus Broadcasting Licence £2 5s.

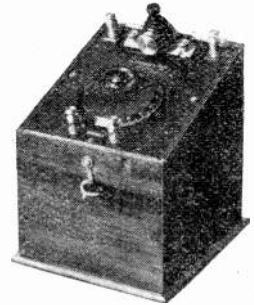

Crystal Set

An ideal Set for receiving local broadcasting clear and distinct, suits everyone's purse.

Reception up to 25 miles

PRICE (with phones) £5

Broadcasting Licence 7/6.

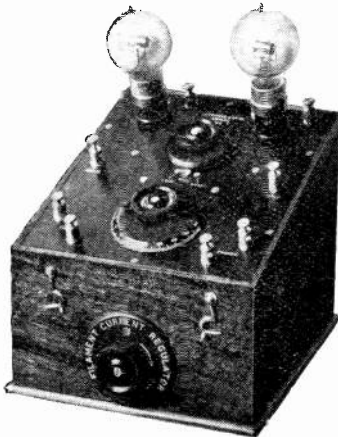

Two Valve Set

The above is designed on the same lines as the three valve Set and will find its way into many homes on account of its marvellous value and efficiency. Range 300-3,000 metres. Reception range the same as three valve set.

PRICE (including phones) £10

Plus Broadcasting Licence £1 15s.

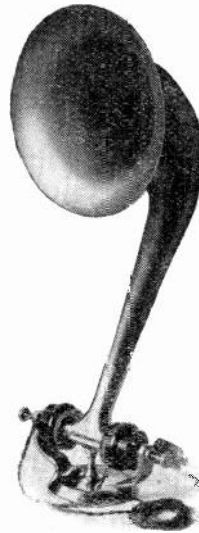

Loud Speaker Adaptor

An ebonite horn with attachment for Headphones.

PRICE £2 15s.

Demonstrations of all the above given daily.

J. A. Coomes & Co., Ltd., 41, New Oxford St., W.C.
(Opposite Mudie's) Museum 3642.

CITY WIRELESS SUPPLIES, 280 City Road, Hulme, Manchester.

THE HOUSE FOR QUALITY & BEST WORKMANSHIP.
CONDENSER UNIT No 1. '001 and '0005 Variable Condensers.
SPECIFICATION. 1st grade Mahogany Box, 7" x 5" x 4" deep. Finished best French polish. Condensers fitted with highest quality ebonite dial and knob, 0° to 180°. Best quality ebonite panel, rounded edges. Price £1 12s. 6d.

CONDENSER UNIT No. 2. Materials and finish as above. Fitted with '0005 and Vernier in parallel for fine tuning. Price £1 5s. each. Condenser panels built to clients designs. All our apparatus is fully guaranteed and only best materials are used.
 All Wireless items stocked. Carriage paid over 10/-. Trade enquiries invited.

THE WIRELESS AGE

THE AMERICAN MONTHLY JOURNAL OF WIRELESS TELEGRAPHY AND TELEPHONY

A "Go-ahead" Magazine for Operators and Amateurs.

Sole European Agents: THE WIRELESS PRESS LTD., 12-13 Henrietta St., Strand, London, W.C.2

Dry Batteries for Wireless Sets

No 1 W. Standard Pocket-lamp size, 4½ volts (as illustration), with patent spiral wire terminals for connecting in series. Insert straight terminal in spiral of next battery and bend same, no soldering required.

PRICE 7/- Per doz.
 NOTE.—(1 doz. = 54 volts).

NEW TYPE.
No. 2 W. Slab.
 15 volts, 1 screw terminal, 5 plug sockets, 3-volt tappings with wander plug.
 Size 9" x 7" x 2½" high.

PRICE 3/- EACH

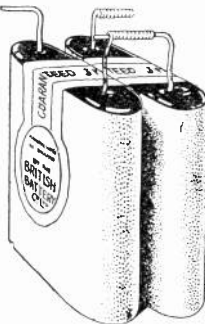

NEW TYPE.
No. 4 W.
 36 volts, 1 screw terminal, 12 plug sockets, 3-volt tappings with wander plug. Size 9½" x 1½" x 2½" high.

PRICE 7/- EACH

No. 1 W.
 Connect as illustration. (Patent applied for).

BRITISH MADE—CARRIAGE PAID.

Manufactured by—
THE BRITISH BATTERY Co., Ltd.
 Clarendon Rd., WATFORD, HERTS.
 (Telephone: Watford 617.)

Revised and Enlarged Edition

AMATEURS This is just what you want

THE VEST POCKET
DICTIONARY
 OF
TECHNICAL TERMS
 USED IN
WIRELESS WORK

By Harold Ward
 Over 1500 definitions

Price 2/6 net. Post free 2/9

The Wireless Press, Limited
 Dept. W.W.
 12-13, Henrietta Street, Strand, London, W.C.2

WITH GOOD APPARATUS YOU CAN GET GOOD RESULTS
 THE "W.P."

Morse Practice Key

Well Made. First-class Finish. Thoroughly Reliable.

Price 7/6 Post Free

THE WIRELESS PRESS, LTD.
 12-13, Henrietta Street, London, W.C.2

Questions and Answers COUPON

To accompany Questions sent in during the week commencing Dec. 30th, 1922.

VOL. XI, NO. 13.

See Conditions on Page 449.

The Students' Library

Useful Notes on Wireless Telegraphy

By Harold E. Penrose

5 Books

Price **1/4** each

Post free **1/6**

BOOK I.

DIRECT CURRENT

The first part of this book is devoted to an outline of Wireless Telegraphy.

The sixteen chapters deal concisely with the Electric Circuit, Ohm's Law, Resistances, Energy, Power and Works, Magnetism, Electromagnets, Amp., Volt- and Wattmeters. The accumulator, Generator, Motor, Self-inductance, etc.

BOOK II.

ALTERNATING CURRENT

Briefly stated the contents are Sine Law; Virtual Value, Phase, Lagging Currents, Effects of Self-Inductance, Inductance, Capacity, Arrangement of Condensers, Condensers with Alternating E.M.F., Leading Circuits, Impedance and Phase, Resonance, Transformer, etc.

BOOK III.

HIGH-FREQUENCY CURRENT AND WAVE PRODUCTION

The meaning of Frequency, the difficulties met with in H.F. machines, the production of H.F. by Condenser Discharge, are explained here. Also the general conditions for Oscillations, Wave Motion, Pressure Waves, Damped and Undamped Waves, The Transmitter, Various Circuits and many other points are efficiently treated.

5
OF OUR
65

BOOK IV.

THE 1½ K.W. SHIP SET

As can be gathered from the title, the author makes clear the details of a standard ship set. And not the least important part of this work is the section devoted to Fault Tracing.

The chapter in which the Crystal Detector is discussed will appeal to many possessors of Crystal Sets.

BOOK V.

THE OSCILLATION VALVE

The numerous diagrams which illustrate the text make this book a valuable one to those who possess or are considering the possession of a valve set.

Throughout this set of five books, the reader is given a series of references which will enable him to obtain the exact work which deals fully with any part of the subject he is particularly interested in.

The Wireless Press, Ltd.

12/13, Henrietta Street, Strand, London, W.C. 2

The FELLOPHONE



2-VALVE RECEIVING CABINET

A high grade instrument at a very low price. This set has been especially designed for receiving broadcasting, and complies with all the Postmaster-General's regulations. It can be used either for listening in with headphones or with a loud speaker.

Additional interest and use is secured because it will receive all amateur transmitting stations within a range of 20 miles. The "Fellophone" is mounted in a handsome oak cabinet and is sent out complete with H.T. battery, 6 volt Accumulator, 100 foot aerial, 2 shell insulators and one pair of Fellows 4000 ohms double headphones, but without valves.

British Made Throughout.

PRICE COMPLETE **£9 : 0 . 0**

(Without Valves) (Carriage 2/-)

EXTRA FOR 2 MULLARD "ORA" VALVES, 30/-
EXTRA FOR ADDITIONAL FELLOWS DOUBLE HEADPHONES, 21/- (postage 1/-).

FELLOWS MAGNETO Co., Ltd.

LONDON, N.W.10

Telephone: Willesden 1560-1.

Telegrams: Quixn.ag. Phone, Lcodco.

For they are jolly good Fellows

BROADCASTING RECEIVERS

□□□

All Sets Bear the B.B.Co. Seal and are Fully Approved by H.M. Post-master-General

□□□



□□□

All Prices Include B.B.Co. Commission and Royalty to Marconi's W/T Co. Ltd.

□□□

LIST No. 514 A

Crystal Receiver, Patents applied for	-	List No. 500	£2 17 6	
Crystal Receiver, with Phones and Aerial	-	List No. 500A	4 17 6	Valves
Single Valve Note Magnifier for above	-	List No. 501	4 12 6	for
Two Valve Note Magnifier for above	-	List No. 502	7 2 6	These
Combined Crystal and Valve Set	-	List No. 503	9 5 0	Sets
Complete Two Valve Cabinet Receiver	-	List No. 512	14 15 0	M.O.
Complete Three Valve Cabinet Receiver	-	List No. 513	19 0 0	Type
Complete Three Valve Cabinet Receiver	-	List No. 513A	21 0 0	17/6
Complete Four Valve Cabinet Receiver	-	List No. 514	23 15 0	Each
Complete Four Valve Cabinet Receiver	-	List No. 514A	26 5 0	
Complete Five Valve Cabinet Receiver	-	List No. 515	30 7 6	

□□□

WRITE FOR OUR CATALOGUE OF BROADCASTING RECEIVERS, Now Ready

□□□

DEMONSTRATION AND SHOWROOMS: Liverpool House, Middlesex Street, E.1

Two minutes walk from Liverpool Street and Broad Street Stations.

TRADE TERMS ON APPLICATION.

Works :

"LIVERPOOL HOUSE,"
Middlesex St., LONDON, E.1
Phone—Avenue 4871.

H. W. Sullivan, Ltd.

Formerly H. W. SULLIVAN, Founded in 1900
Telegrams—"Deadbeat, Stock, London."

Offices :

WINCHESTER HOUSE,
LONDON, E.C.2, ENGLAND
Phone—London Wall 3518



Printed by Sanders Phillips & Co., Ltd., Chryssell Road, London, S.W.9, for the Proprietors and Publishers, The Wireless Press, Ltd., 12-13, Henrietta Street, London, W.C.2; Sydney, N.S.W., 97, Clarence Street; Melbourne, 422-24, Little Collins Street; New York, 326, Broadway.

